



Prepared for the U.S. General Services Administration
By the National Renewable Energy Laboratory (NREL)

JANUARY 2021

Case Study: Field Evaluation of a Low-Cost Circuit-Level Electrical Submetering System

Willy Bernal Heredia (NREL)

Dylan Cutler (NREL)

Jesse Dean (NREL)

Disclaimer

This document was prepared as an account of work sponsored by the United States Government. While this document is believed to contain correct information, neither the United States Government nor any agency thereof, nor the National Renewable Energy Laboratory, nor any of their employees, makes any warranty, express or implied, or assumes any legal responsibility for the accuracy, completeness or usefulness of any information, apparatus, product, or process disclosed, or represents that its use would not infringe privately owned rights. Reference herein to any specific commercial product, process or service by its trade name, trademark, manufacturer, or otherwise, does not constitute or imply its endorsement, recommendation or favoring by the United States Government or any agency thereof, or the National Renewable Energy Laboratory. The views and opinions of authors expressed herein do not necessarily state or reflect those of the United States Government or any agency thereof, or the National Renewable Energy Laboratory.

The work described in this report was funded by the U.S. General Services Administration and the U.S. Department of Energy under Contract No. DE-AC36-08G028308.

Acknowledgements

GSA Region 8: Tyler Cooper, Aaron Rodriguez, Robert Smith, and Steven Lanyon

Meazon: Stelios Koutroubinas, John Gionas, Vagelis Fergadiotis, and Nikos Betsos

Mountain Energy Partnership: Ed Hancock, Greg Barker, and Paul Norton

For more information, contact:

Willy Bernal Heredia

Research Engineer

National Renewable Energy Laboratory

Phone: (303) 384-7404

Email: willy.bernalheredia@nrel.gov

GSA's Proving Ground (GPG) program enables federal and commercial building owners and operators to make sound investment decisions in next generation building technologies based on their real-world performance.

Executive Summary

Circuit-level metering technologies provide the ability to monitor individual circuits within an electrical panel in a building, providing detailed power and energy consumption data at a much more granular level than was previously achievable in a cost-effective manner. While the fundamental hardware components of circuit-level technologies—split-core current transformers (CTs) and power monitoring meters—have existed for some time, new offerings in the market have integrated these components more compactly, lowered costs, and streamlined data organization, transport, and access via software solutions accessible through web and application programming interfaces (API).

Building owners and operators typically face multiple challenges to access data on electrical power and energy consumption within a building. They may have access to whole-building electrical data via advanced metering infrastructure (AMI), but very rarely do they have insight into the power and energy consumption of individual end uses or devices. This lack of visibility into electrical data limits the ability to identify issues with individual pieces of equipment, quantify consumption of specific end uses or tenants, or present occupants with accurate data about their energy consumption as building users. Circuit-level metering allows for various innovative use cases, such as tenant billing, tenant engagement, measurement and verification (M&V), automated fault detection and diagnostics (FDD), identification of energy conservation measures (ECM), time-of-use management, and demand response.

Major adoption of this technology has not occurred due to prohibitive cost, unreliable data communication, and reduced interoperability. To address these shortcomings, the U.S. Department of Energy (DOE) put out the Low-Cost Wireless Metering Challenge that elicited manufacturers to produce a cost-effective, accurate, wireless system to measure diverse electric loads within a building and relay the data wirelessly. In March 2017, Meazon was declared the winner of that competition. The National Renewable Energy Laboratory (NREL) evaluated Meazon's circuit-level analytics and submetering platform (CLASP), in which one meter is required to measure each three-phase load.

NREL examined the metering technology in a field deployment where it was installed in 120V/208V and 277V/480V commercial electrical panels and circuit disconnects in the César E. Chávez Memorial Building in Denver, Colorado. The evaluation of the equipment under test (EUT) focused on three aspects: (1) accuracy of the data provided by the system, (2) ease of technology installation and data integration into existing U.S. General Services Administration (GSA) analytics platforms, and (3) total cost of ownership and cost-effectiveness of the technology. The specific performance criteria outlined for this demonstration, as well as success criteria and results of testing, are outlined in Table ES-1. The table and summary of the results (according to each objective) are presented next.

Table ES-1: Performance Objectives

Quantitative Objectives	Metrics and Data Requirements	Success Criteria	M&V Results
Submeter Accuracy In-Situ Field Demonstration	<ul style="list-style-type: none"> • Current • Voltage • Real power • Power factor • Energy 	<ul style="list-style-type: none"> • Measurement accuracy of energy consumption (as cumulated over 2–4 weeks) of +/- 10% • Measurement accuracy of +/-10% for total power measurements¹ • 95% data availability over the course of the demonstration 	Partial: Total energy error was <2% for all Wye loads. Delta loads showed higher errors at low power factors.
Qualitative Objectives			
Ease of Installation and Integration with GSA Information Technology (IT)/Enterprise Systems	<ul style="list-style-type: none"> • Level of technical expertise required • Time required to install and configure • Customer labor associated with install • Data integration requirements • Security requirements • Ease of visualizing and downloading data 	<ul style="list-style-type: none"> • Ability to be installed in the majority of GSA’s electrical panels • Ability to integrate into GSA Link infrastructure • Generally applicable to >70% of GSA facilities 	Met: Successfully and efficiently installed in a variety of panels. Demonstrated integration with software components of GSA Link.
Value Proposition and Cost-Effectiveness	<ul style="list-style-type: none"> • Installation and operations and maintenance (O&M) cost • Energy and cost savings identified • Value of tenant billing • Value of FDD 	<ul style="list-style-type: none"> • Potential savings exceeds expected installation and O&M costs • Software offers measurement and analytics capabilities that address industry needs • Data from software can be utilized to identify a significant portion of the faults and ECMs identified by the GSA Link software (75% or more) • Determine if life cycle is cost-effective as a stand-alone platform 	Met: Technology demonstrated ability to identify relevant behavior (e.g., cycling, on/off, seasonal trends) and capability to be life cycle cost-effective. No subscription cost for retrieving data.

¹ Evaluation of meter accuracy during laboratory testing demonstrated that comparison to stated accuracy in product literature was not appropriate for field testing success criteria. Accuracy values in product literature were developed using controlled voltage/current sources and are not reflective of in-field operation and, therefore, should not be the success criteria for this objective.

i. Submeter Accuracy In-Situ Field Demonstration

The CLASP was able to provide high-resolution and accurate power and energy consumption data (for most loads) that provides insights into equipment operation and supports the value propositions outlined in Table ES-1. Total energy error was less than 2% for all Wye configuration loads when they were operating. It captured accurate data for dynamic swings (e.g., variable air volume [VAV] equipment) and more steady behavior (e.g., panel mains). Figure ES-1 shows the time series data for two devices (the panel mains and a fan-powered VAV box with a constant volume fan) with distinct characteristics in the field demonstration. This figure demonstrates how well the EUT was able to track the power signal of the device (red trace), as compared to the revenue-grade submetering installed by NREL, denoted by “reference” and the green trace. The CLASP featured low average percent error (<4%) for all Wye loads during operation. However, the accuracy was impacted at low power factor (<50%) for Delta configuration loads. The vendor suggested using the latest version of the meter, which was not available at the planning stage. NREL has not vetted those claims.

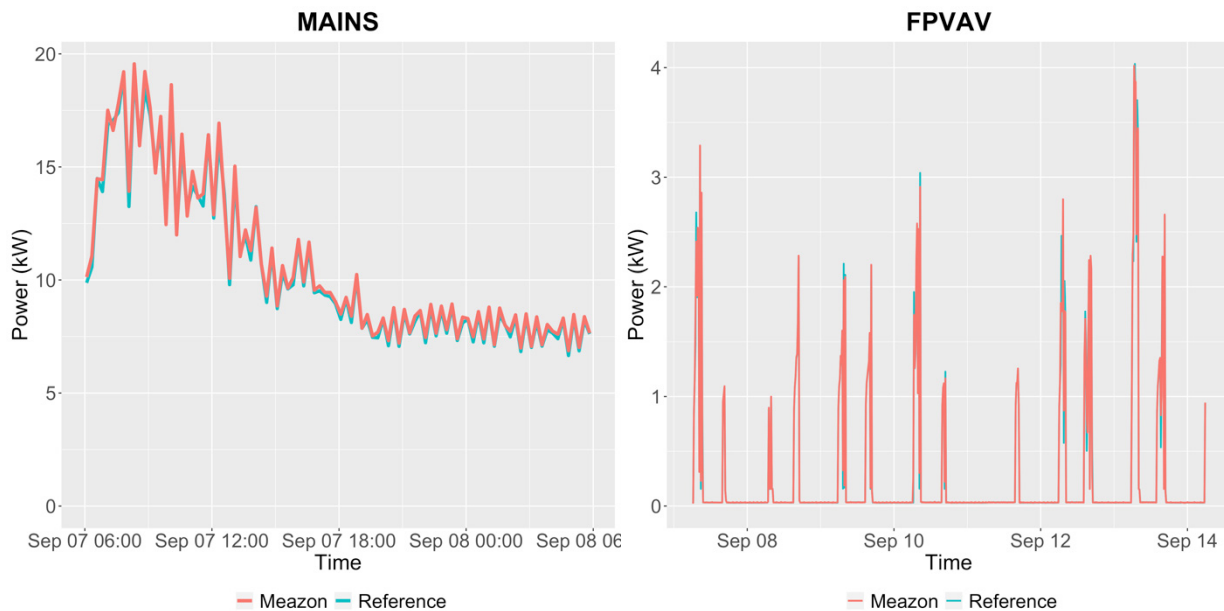

Figure ES-1: Accuracy results for two devices in the field demonstration. One day of panel mains data is shown in the left figure, and a whole week of a VAV device operation in the right.

ii. Ease of Installation and Integration with GSA Information Technology (IT)/Enterprise Systems

This technology proved easy to install by a certified electrician, who completed the install of six meters in two separate panels (120/208 V and 277/480 V) and two circuit disconnects (along with associated commissioning) at the César E. Chávez Memorial Building in six hours. The technology was installed in high- and low-voltage panels with limited space in the electrical room, demonstrating the applicability of this technology to almost all commercial buildings in the GSA portfolio. Primary considerations for this technology include appropriate sizing of CTs for each circuit, selection of loads/circuits/panels that are of high value for detailed submetering

(e.g., tailored for high-load devices), and GSA's preference on data integration with its existing energy management infrastructure.

Through the field evaluation, NREL and GSA demonstrated data integration from the vendor system into the primary software component on the GSA enterprise-level energy management and information system, GSA Link. Data from the CLASP was integrated into this platform to demonstrate the compatibility and assess the level of effort. This demonstrated the ability of the CLASP to augment existing energy management and information systems in buildings where GSA Link is deployed and provides a pathway for delivering FDD at other buildings throughout the GSA portfolio.

iii. Value Proposition and Cost-Effectiveness

This objective is challenging to assess because the metering technology may not directly produce cost savings, but instead enable multiple value propositions. An extensive cost-effective analysis of the technology was outside the scope of this project. Instead, NREL identified which value propositions can be accomplished by the technology and collected manufacturer information to estimate the total cost of ownership. The CLASP successfully identifies relevant behavior (e.g., cycling, on/off, seasonal trends) for ECM identification. No ECMs were identified, but the data accuracy and resolution were sufficient to demonstrate it is possible to detect ECMs and monitor potential savings. The CLASP provides an appealing solution for tenant billing due to high accuracy (even though it has not been certified as revenue-grade) and resolution (1-min) as well as low per-point cost. The total cost of ownership was calculated for the pilot deployment and for a larger installation. The equipment cost to meter a single three-phase load was estimated to be \$498 and \$132 for small and larger installations (>1,000 units), respectively. Those price points can be achieved due to zero subscription fees for retrieving data from the vendor's web server. The CLASP also provides an advanced IoT platform with artificial intelligence technology that can resolve issues such as installation error (regarding phase sequence) and provide software correction. It can also combine other type of sensors in multi-site distributed architectures. Those analytic services range from \$12 to \$48 per meter per year, depending on requested service features. NREL did not assess the effectiveness or performance of those services.

The vendor supported NREL with valuable technical information needed to achieve a successful demonstration. Alongside this deployment, the manufacturer has also been developing new meters and enhancements to their platform; they believe their new DinRail Advanced meters can provide higher accuracy and enhanced features than the one evaluated, though that meter was not available at the onset of this field evaluation. NREL has included recent technology enhancements performed by the vendor in this report. The CLASP meter features advanced monitoring capabilities to measure harmonics (up to the 45th) and implements disaggregation and predictive maintenance services. Assessment of the new meters were outside the scope of this project.

Table of Contents

I.	INTRODUCTION	7
	A. What We Studied	7
	B. Why We Studied It	10
II.	EVALUATION PLAN	12
	A. Evaluation Design	12
	B. Testbed Site	14
	C. Methodology	16
III.	DEMONSTRATION RESULTS	21
	A. Quantitative Results	23
	B. Qualitative Results	25
	C. Total Cost of Ownership and Cost-Effectiveness	27
IV.	SUMMARY FINDINGS AND CONCLUSIONS	30
	A. Overall Technology Assessment at Demonstration Facility	30
	B. Lessons Learned and Best Practices	31
	C. Deployment Recommendations.....	32
V.	APPENDICES	34
	A. Manufacturer Cut Sheet.....	34
	B. User Interface.....	35

I. Introduction

A. WHAT WE STUDIED

In March 2017, DOE recognized Meazon as the winner of the Low-Cost Wireless Metering Challenge. This DOE initiative's goal was to encourage manufacturers to produce a cost-effective, accurate, wireless system that can measure diverse electric loads within a building and relays the data wirelessly. NREL was tasked with the evaluation of the vendor technology: the circuit-level analytics and submetering platform (CLASP). This report presents the results of the assessment of the hardware/software solution that provides circuit-level analytics and submetering platform for commercial buildings. The CLASP was deployed in a pilot installation in commercial electrical panels and equipment disconnects at the César E. Chávez Memorial Building in Denver, Colorado.

Circuit-level metering is a fast-growing technology area. New products continue to be developed that allow building owners and operators to gain increased insight into the electrical consumption of their facility at significantly reduced costs compared to incumbent technology and approaches. This legacy technology corresponds to standard metering such as the Campbell Scientific equipment (WattNode²) that provides high accuracy at the expense of longer installation time, installation complexity, higher costs, and larger form factor. This report describes the standard technology in more detail in Section II.C.i. Circuit-level metering technologies typically use split-core current transformers (CT) to measure the current flowing through the electrical wiring. Readings from the CT are combined with voltage readings from the electrical panel (or user input voltage values) to calculate the power consumption of the devices. This data is then transmitted to a data historian that is hosted either locally or in the cloud. Data transport methodologies vary—methods include wired (e.g., ethernet) and wireless options (e.g., Wi-Fi, cellular)—and systems keep varying amounts of data locally on hardware or bridges as a buffering mechanism for any network interruptions in delivering data to the larger data historian. This data is then made accessible to the user through a user interface, typically a web interface. Web interfaces provide a variety of data analytics offerings, varying from simple data access/visualization to development of rule-based alarms and complex benchmarking and fault detection and diagnostics (FDD) algorithms. Many companies also support programmatic access to the data via an application programming interface (API).

The CLASP, analyzed in this study, is available in single-phase and three-phase configurations. The system provides a highly compact data acquisition system consisting of a meter, a wireless communication bridge that can collect data from multiple meters, and non-proprietary CTs. Thus, the CLASP works with CTs from other manufacturers. The meter and the bridge communicate wirelessly through a Zigbee-standard industry protocol compatible with the IEEE 802.15.4 specification. NREL evaluated the ZigBee-enabled meter with a stand-alone gateway (or bridge). However, the CLASP provides different system configurations that include integrated solutions for the meter and gateway.

² The WattNode is a kilowatt-hour (kWh) energy and power meter that measures 1, 2, or 3 phases with voltages from 120 to 600 volts VAC and currents from 5 to 6,000 amps. <https://ctlsys.com/product/wattnode-modbus/>

To ensure good connectivity, the bridge is mounted in the vicinity of the meters where individual loads or circuits are to be measured. The split-core CTs are installed in the electrical panel.

The system transmits at 1-min intervals (calculated from high-frequency sampling at the sensor level) to the cloud, where the data is stored and made accessible through the vendor’s web-based analytics platform. Other transmission rates are possible through custom configurations. The system also supports a RESTful API³ for programmatic data access. The hardware and software suite represents a streamlined set of components where the data processing, calculations, and local data storage are all housed in small form factor equipment and where the installation is streamlined via the limited, plug-and-play components (Figure 1).

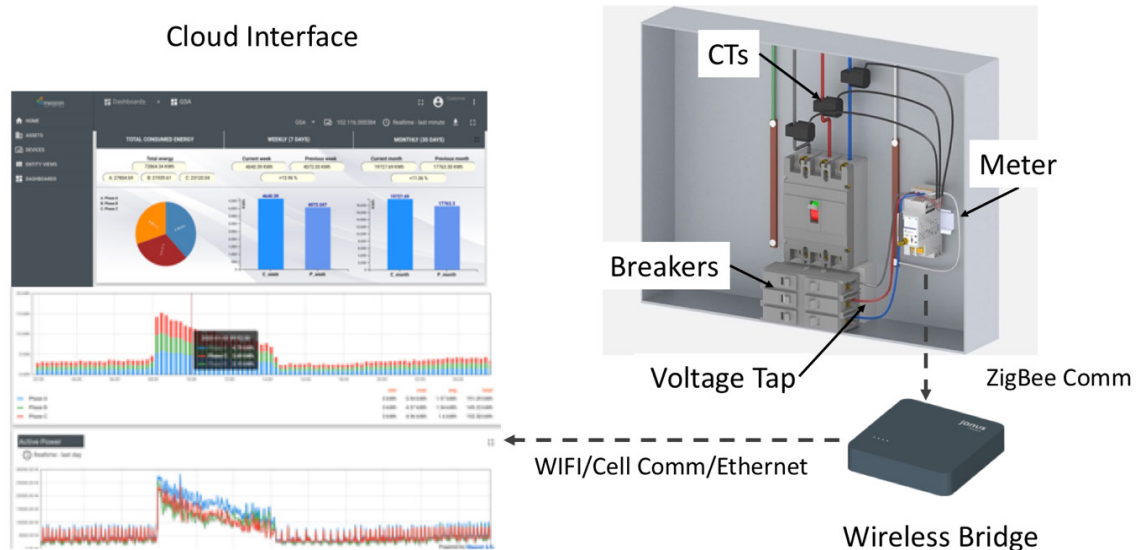

Figure 1: CLASP diagram

Table 1 and Table 2 show the specifications on the single-circuit system: CTs, meter, and bridge device. The CLASP’s meters are compatible with DIN⁴-Rail mounts for convenience.

³ A RESTful API is an architectural style for an API that uses HTTP requests to access and use data.

⁴ DIN is stands for Deutches Institut fur Normung, which in English means German Institute for Standardization.

Table 1: CLASP Technology Specifications

Characteristic	DIN-Rail Energy Submeters
Description	Wired split-core current transducers with wireless meter. Single-phased meter monitors one single-phase load. Three-phase meter monitors one three-phase load.
Service Type	Single-phase, three-phase
Measurement Type	Current (A), voltage (V), power factor, frequency (Hz), power (kW), reactive power (kVAR)
Transmission Frequency	Configurable up to 1 second (e.g., 1, 5, 15 min)
CT	Consult with Meazon for sizing and selection
Input Power	External power (from circuit)

Table 2: Equipment and System Configurations

Category	Equipment	Features
Meter	DinRail ULTRA 3-Ph (gateway required)	ZigBee enabled
	DinRail ADVANCED NB (gateway not required)	NB-IoT ⁵ enabled
		General Packet Radio Services ⁶ enabled
		LTE Cat-M1 enabled
Gateway	Meazon Janus	Gateway

⁵ NarrowBand-Internet of Things (NB-IoT) is a standards-based low power wide area technology designed for IoT devices and services.

⁶ General Packet Radio Services is a packet-based wireless communication standard designed for mobile communication.

B. WHY WE STUDIED IT

Building owners and operators typically have a challenging time accessing data on electrical power and energy consumption. They may have access to whole-building electrical consumption data via AMI, but very rarely do they have insight into the power and energy consumption of individual end uses. This lack of visibility into electrical data limits the ability to identify issues with individual pieces of equipment, quantify consumption of certain end uses or tenants, and present occupants with accurate data about their energy consumption as building users.

Circuit-level metering provides the ability to monitor power at each electrical circuit in the building, providing insight into different types of end-use consumption (e.g., plug loads; lighting loads; or heating, ventilating, and air conditioning [HVAC]), specific device-level consumption, or the floor- or panel-level consumption within a building. Circuit-level metering allows for various innovative use cases, such as tenant billing, tenant engagement, measurement and verification (M&V), automated FDD, identification of energy conservation measures (ECM), time-of-use management, and demand response. A listing of each value proposition and a brief description are provided in Figure 2.

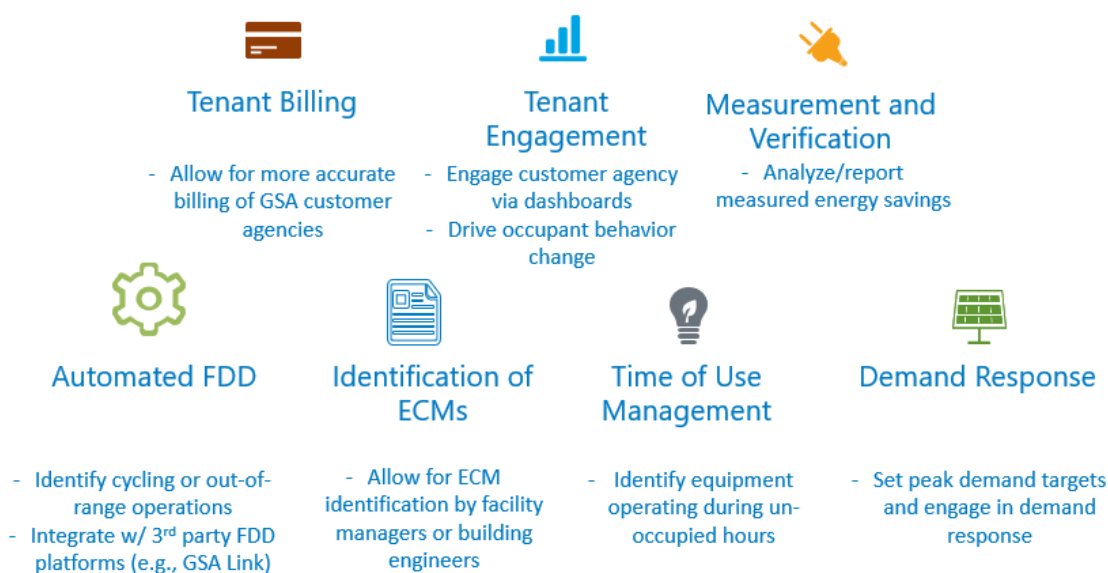

Figure 2: Circuit-level metering value proposition

Metering does not save energy directly, but rather is an enabling technology that allows for more thorough and comprehensive energy management. The enhanced visibility of specific end-use or device-level energy consumption and the analytical insights provided by this technology promise to be more granular and scalable than data delivered by traditional submetering.

Standard approaches to submetering in buildings have been either tailored AMI deployment or custom installations of circuit-level submetering. AMI is typically installed at the whole-building or large end-use level (e.g., chiller plant) and utilizes utility-grade, solid-state meters. Federal agencies and other large organizations have been increasingly installing electrical meters and associated

communications and data storage equipment as a part of AMI deployment in the last two decades. AMI installations at federal facilities typically consist of installing a revenue-grade whole-building interval electrical meter, gas meter, steam meter, or water meter that collects 15-min or 1-hour interval data. The data from the AMI meters is communicated through the local area network (LAN), the building automation system (BAS), radiofrequency, or wireless network communication to a central database. The steep cost of deploying AMI, ranging from few to several thousand dollars per meter (including installation), and its applicability to individual large loads do not allow for detailed and scalable submetering within a building. The new developments in circuit-level metering—streamlined or integrated hardware and data hosting/analytics solutions—are driving costs down and warrant an investigation into the quality and cost-effectiveness of these new marketplace solutions.

When evaluating the different value propositions that the circuit-level metering system offers, three main value propositions were identified as of interest to the U.S. General Services Administration (GSA):

1. The ability of the submeter to:
 - a. Interface with three-phase electrical panels in commercial facilities
 - b. Accurately perform AC electrical measurements (real power (kW) and energy)
 - c. Operate over specified ranges for current and voltage
 - d. Meet specified time resolution capabilities
 - e. Attain measurement accuracy of +/- 10% at full range (as stated by CT specifications)
 - f. Perform long-term data logging and storage in the gateway (storing up to 15 million measurements)
 - g. Transmit data between meter and gateway effectively with >95% uptime
2. The ease of installation, data retrieval, and interoperability with legacy systems (e.g., GSA Link)
3. The total cost of ownership of the system (including meters, gateway, and any required recurring costs to be able to access metered data).

The vendor technology is at technology readiness level (TRL)⁷ 8. The products have been tested in an operational environment, are at a complete design phase, and are available in the market. This demonstration effort verified that the final systems perform as expected in the field environment, assisting in completing the transition to TRL 9.

⁷ TRLs are a method of estimating technology maturity of Critical Technology Elements. DOE defines its own TRL; please refer to <https://www2.lbl.gov/dir/assets/docs/TRL%20guide.pdf>

II. Evaluation Plan

A. EVALUATION DESIGN

Evaluation of this technology focused on three aspects of the single-circuit submetering technology: (1) accuracy of the data provided by the system, (2) ease of installation of the technology and ease of data integration into existing GSA analytics platforms, and (3) total cost of ownership and cost-effectiveness of the technology. Table 3 summarizes the performance objectives for this demonstration.

Table 3: Performance Objectives

Quantitative Objectives	Metrics and Data Requirements	Success Criteria
Submeter Accuracy In-Situ Field Demonstration	<ul style="list-style-type: none"> • Current • Voltage • Real power • Power factor • Energy 	<ul style="list-style-type: none"> • Measurement accuracy of energy consumption (as cumulated over 2–4 weeks) of +/- 10% • Measurement accuracy of +/-10% for total power measurements⁸ • >95% data availability over the course of the demonstration
Qualitative Objectives	Metrics and Data Requirements	Success Criteria
Ease of Installation and Integration with GSA IT/Enterprise Systems	<ul style="list-style-type: none"> • Level of technical expertise required • Time required to install and configure • Customer labor associated with install • Data integration requirements • Security requirements • Ease of visualizing and downloading data 	<ul style="list-style-type: none"> • Ability to be installed in the majority of GSA’s electrical panels • Ability to integrate into GSA Link infrastructure • Generally applicable to >70% of GSA facilities
Total Cost of Ownership, Value Proposition and Cost-Effectiveness	<ul style="list-style-type: none"> • Installation and O&M cost • Energy and cost savings identified • Value of tenant billing • Value of FDD 	<ul style="list-style-type: none"> • Potential savings exceeds expected installation, O&M costs • Software offers measurement and analytics capabilities that address industry needs • Data from software can be utilized to identify a sizable portion of the faults and ECMs identified by the GSA Link software (75% or more) • Determine if life cycle is cost-effective as a stand-alone platform

⁸ Evaluation of meter accuracy during laboratory testing demonstrated that comparison to stated accuracy in product literature was not appropriate for field testing success criteria. Accuracy values in product literature were developed using controlled voltage/current sources and are not reflective of in-field operation and therefore should not be the success criteria for this objective.

i. Accuracy

NREL assessed data accuracy in a field deployment in a GSA building in downtown Denver (see Section B). The CLASP was installed on circuits within electrical panels and equipment disconnects that captured a variety of end uses and a range of power demand magnitudes. A description of the site, equipment, and panel selected is presented in Section B. To quantify the accuracy of the data acquired by the circuit-level submetering, NREL installed high-accuracy, revenue-grade submetering on the same set of circuits as the metering technology under evaluation. Data were collected simultaneously from the CLASP and the revenue-grade metering, allowing for assessment of the accuracy provided by the system.

Successful performance in the accuracy evaluation portion of this demonstration was evaluated via the following quantitative objective:

Quantitative Objective 1: Submeter Accuracy In-Situ Field Demonstration and Associated Data Availability

- Success criteria:
 - The technology demonstrates the ability to provide energy and power data of sufficient accuracy to enable tenant billing, identification of ECMs, and the quantification of savings due to those ECMs. Technology demonstrates purported data storage capabilities. Measurement accuracy is less than +/-10% for total power measurements.
 - The technology provides sufficient data availability to function effectively in a tenant billing system (95% data availability throughout the demonstration).

ii. Ease of Installation/Integration

The second goal of this demonstration was to evaluate the ease of installation of the equipment under test (EUT) and the ease of data integration into existing GSA analytics platforms. Ease of installation and ease of use are key considerations for energy submetering technologies because labor costs associated with installation and use may exceed the cost of the hardware. To assess this objective, NREL oversaw the installation process of the submetering system, documented the level of effort, and interviewed the GSA staff or contractors responsible for installing the product.

Additionally, NREL worked with the GSA Link team to assess the possibility of integrating vendor data into the GSA enterprise energy management and information system. GSA Link is an analytics platform that GSA uses to evaluate the performance of its buildings, track issues, and initiate work orders for project execution. The ease of installation and integration was assessed via the following qualitative objective:

Qualitative Objective 1: Ease of Installation and Ease of Integration with GSA Link System

- Success criterion:
 - The ability of the technology to be installed in the majority of GSA's applicable electrical panels and the ability to be integrated into GSA Link architecture.

iii. Total Cost of Ownership and Cost-Effectiveness

The final evaluation criterion for this demonstration was an evaluation of the total cost of ownership and the cost-effectiveness of the technology. The cost calculation includes labor (e.g., installation and commissioning), equipment (e.g., meters, gateway, and CTs), and any recurring operation cost (e.g., subscription fees). Assessment of cost-effectiveness is challenging because there are no energy savings causally related to the acquisition of high-quality data. The data must be acted upon to derive savings from this technology. Additionally, the opportunities for savings may be vastly different between different buildings or different equipment that is measured using the metering technology. To provide some insight on the cost-effectiveness of this technology, we evaluated the amount of savings that must be delivered to offset the technology cost.

To ensure that NREL could test this objective (at least at this specific technology demonstration site), NREL analyzed the type of ECMs that could be detected with the EUT. Additionally, the EUT vendor produces a quarterly report on issues identified by its system as well as the energy and operational efficiency of the building based on the sensor readings. These reports contribute to the evaluation of the ability of the technology to assist in driving energy savings. This portion of the assessment was evaluated by the following objective:

Qualitative Objective 2: Value Proposition and Cost-Effectiveness Analysis

- Success criteria:
 - The technology demonstrates a clear value stream that would enable cost-effective installation and incorporation into GSA Link.
 - The technology demonstrates a clear value stream that would enable cost-effective installation and use as a stand-alone platform.

B. TESTBED SITE

The location selected for this demonstration was the César E. Chávez Memorial Building in downtown Denver, Colorado. The site is a midrise office building of 10 stories with electrical risers and dedicated electrical rooms for each floor. It is a high-efficiency, all-electric, well-operated building.



Figure 3: César E. Chávez Memorial Building (Credit: TRYBA Architects)

The CLASP was installed in two separate locations within the building: (1) the 7th-floor electrical room and (2) in the disconnects of two centrifugal chillers located in the penthouse. The revenue-grade submetering equipment, used as the reference, was installed in two panels on the 7th floor and in the two chillers' disconnects in the penthouse. The NREL reference equipment metered 120V, 208V, and 480V HVAC equipment and panel mains. This combination of submetering allowed NREL to capture multiple load types in the building.

The following site selection criteria were established as relevant for an effective evaluation of the circuit-level submetering technology and were used in the selection of this site:

Required Characteristics

- Multi-tenant building
- The panels are 120/208 V or 277/480 V (three-phase)
- Modern identifiable commercial three-phase breaker panels with variable loads
- Each circuit in the panel serves only one tenant/one end-use type
- Panels provide sufficient space for the installation of CTs and provide space to install a voltage tap (e.g., via a spare breaker)
- The electrical room provides space for temporary installation of ancillary metering equipment for independent M&V
- Location of the electrical panels has good to excellent 4G wireless reception
- The breaker panel circuits are well mapped (i.e., require no circuit tracing and have a current panel card)

Preferred Characteristics

- One breaker panel will serve a data center
- The breaker panel serves loads of mixed types (e.g., lighting and plug loads)
- One breaker panel in the building is the main panel
- The building is a small commercial building—the metered area of the building covers approximately 15,000 ft².

The demonstration site meets most of the recommended criteria, except that it is not a small building. Therefore, whole-building utility data was not able to be used for M&V, and one breaker panel was not the main panel for the building.

C. METHODOLOGY

QUANTITATIVE STUDY DESIGN

To establish the accuracy of circuit-level submetering, revenue-grade submetering was installed alongside the EUT, and data was pulled from the two systems at the same frequency. This enabled comparison of power readings from the two different systems over an extended period. In this section, we describe the field-testing configurations as well as the circuits studied and the associated loads.

i. Field Testing Design

The circuit-level submetering technology was deployed to two separate panels (Figure 4) and two circuit disconnects in the César E. Chávez Memorial Building. The disconnects correspond to two chillers in the penthouse. Table 4 shows the type of load that was monitored for specific panels.

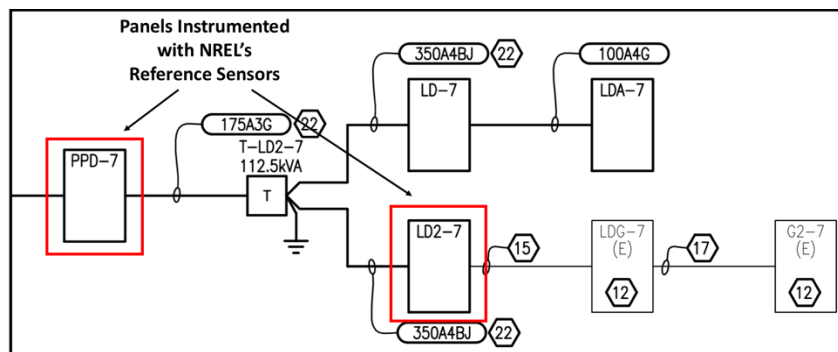

Figure 4: Metered panels on the 7th floor

Table 4: Metered Equipment Specifications

Floor	Panel	Voltage	HVAC	CT Size (Ref.)	Reference Meter	CLASP
7th	PPD-7	277/480 V	Mains	400 A	✓	✓
			Fan-Powered VAV	50 A	✓	✓
	LD2-7	120/208 V	A/C 785	50 A	✓	✓
			8th Floor Server	–		✓
Penthouse	Equipment Disconnects	277/480 V	Chiller 1	600 A	✓	✓
			Chiller 2	600 A	✓	✓

For the circuit-level meter, there were two gateways on the 7th floor (one for every two meters). The gateway (or bridge) communicates wirelessly with the meters via an IEEE 802.15.4-based specification (Zigbee). The data is transmitted from the gateway to the cloud-hosted database for long-term data storage. The meters were logging data at 1-min intervals.

To assess the accuracy of the readings acquired by the EUT, revenue-grade submetering was deployed alongside the EUT in panel PPD-7, LD2-7, and the chillers’ disconnects. For panel PPD-7, the revenue-grade equipment was installed to meter the panel mains and one fan-powered VAV box. The fan-powered systems provide each zone with variable temperature-constant flow supply air. For panel LD2-7, the revenue-grade equipment was installed only on an air-conditioning heat pump. At the penthouse, the reference metering equipment was connected at the disconnect for the chillers. We monitored each phase of the five circuits (three phases each). Each WattNode can monitor at most three phases. Thus, five WattNodes were required to monitor all the loads; one for each three-phase circuit.

The 8th floor server load was not metered with the revenue-grade WattNode meter because of the already existing healthy variety of loads for comparison and the additional cost. A comparison for that load is not presented, as no reference equipment was installed.

The revenue-grade metering technology that was used to assess the accuracy consisted of Continental Control’s WattNode Revenue (RWNC-3Y-480-MB) combined with Continental Control’s revenue-grade Accu-CTs. The Accu-CTs provide accuracy of 0.5% and are tested to ANSI C57.13, Class 0.6, in conjunction with the associated WattNode, to ensure ANSI C12.1 accuracy (0.5% accuracy). The WattNodes are connected to a Campbell Scientific CR-6 data logger via MODBUS communications, and data is communicated from that data logger out to a cloud-hosted database via cellular communications. Data as collected at 1-min intervals from the Campbell Scientific data logger. A typical configuration is shown in Figure 5.

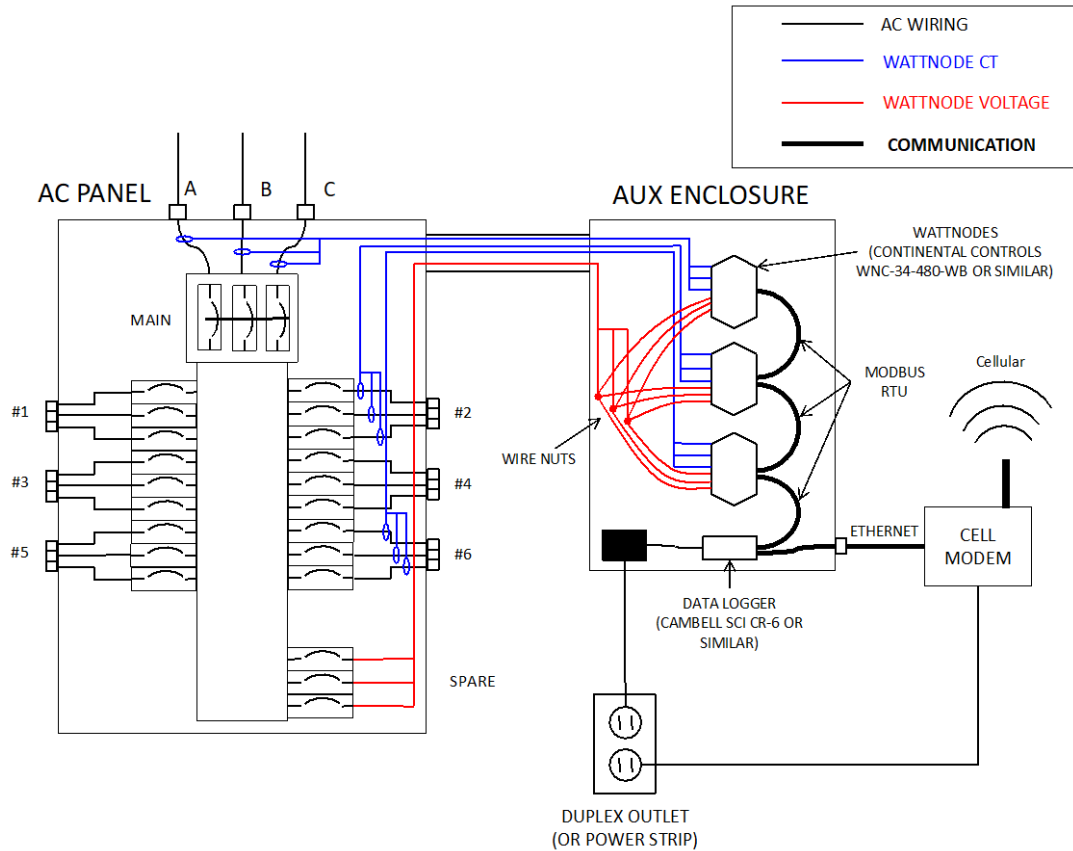

Figure 5: Diagram of NREL submetering configuration (three WattNodes shown in the diagram, but only two used per panel)

Final installation for the 7th floor electrical panel (PPD-7) with the circuit-level technology and three Continental Control meters are shown in Figure 6. Figure 7 shows the installation at the penthouse. The preconfigured CLASP meter box with the disconnect breaker and meter can be seen in Figure 8.

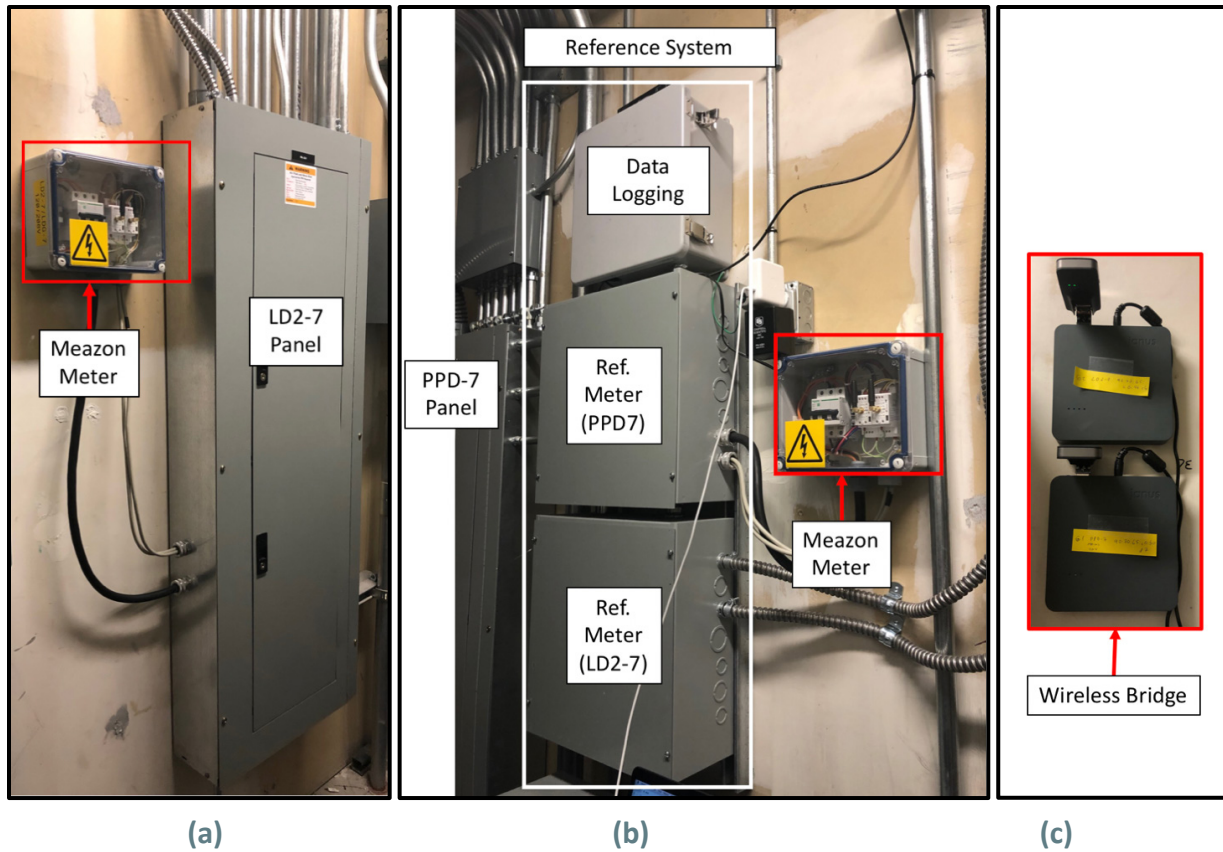

Figure 6: 7th Floor Installation. CLASP's CTs, meters, and bridge are shown inside a red box, and the Continental Control's equipment in a white box.
 (a) Panel LD2-7, (b) panel PPD-7, and (c) the bridges for both panels
 (Credit: Willy Bernal Heredia, NREL)

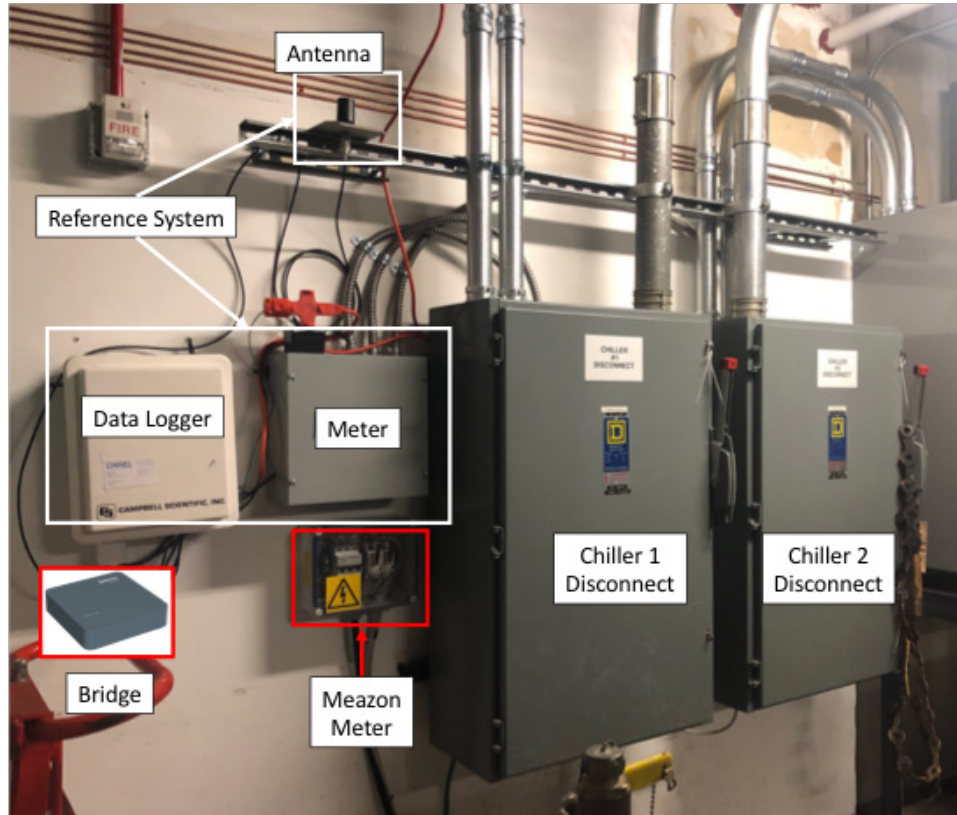

Figure 7: Final installation at the penthouse. CLASP’s CTs, meters, and bridge are shown inside the red box, and Continental Control’s equipment in the white box (Credit: Willy Bernal Heredia, NREL)

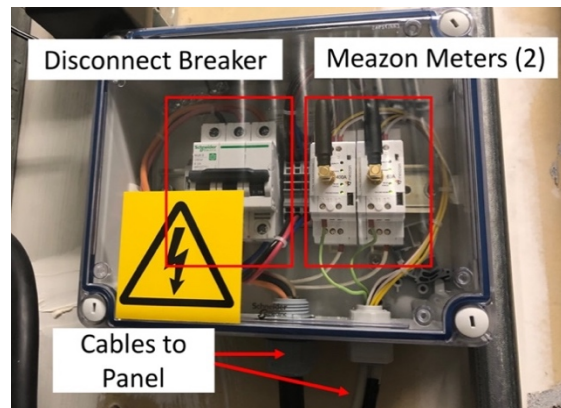

Figure 8: CLASP’s meter enclosure box

QUALITATIVE STUDY DESIGN

To assess the ease of installation for the circuit-level submetering system, NREL observed the electrician’s process for installation during the single-day install. Informal interviews were carried out with the electricians after the installation was complete.

To assess the ability to integrate effectively into the enterprise analytics platform GSA Link, NREL discussed with GSA Link administrators potential pathways for data integration. Additionally, NREL

evaluated the level of effort of integrating the data collected from the CLASP’s meters into GSA Link. NREL leveraged the vendor’s API and uploaded data to an NREL internal server for data storage, processing, and analysis. This demonstrates that a similar approach is viable to work with the GSA Link system. NREL’s internal server implements the same underlying platform as GSA Link.

DATA ANALYSIS

Data from the circuit-level submetering system was pulled via the vendor’s API in 1-min intervals. Similarly, the data from the revenue-grade submetering was pulled from the LoggerNet (data logger) website in 1-min intervals. The data was aligned on timestamp, such that the value at each timestep could be compared between systems.

To calculate the accuracy of the power and energy readings from the circuit-level submetering system, bias and normalized bias (or percent error) were calculated for every timestep during the observation period. The bias between the two readings is defined as: $x_{\text{meas}} - x_{\text{obs}}$, where x_{meas} is the EUT’s measurement and x_{obs} is the revenue-grade submetering. Percent error is defined as $(x_{\text{meas}} - x_{\text{obs}})/x_{\text{obs}}$. Both the bias and the percent error were then averaged over all timesteps and reported as the mean bias and the average percent error. These values show whether the measurements were consistently high or low on an absolute and percent basis, respectively.

These errors were then summarized into a root mean squared percent error (RMSPE) to quantify the magnitude of the combined error in the measurements. RMSPE is defined in Eq. 1.

$$\text{RMSPE} = \sqrt{\frac{\sum_{i=1}^n \left(\frac{x_{\text{meas}} - x_{\text{obs}}}{x_{\text{obs}}} \right)^2}{n}} \quad \text{Eq. 1}$$

It was critical to use the root mean squared *percent* error instead of simply the root mean squared error because of the variability in some of the loads. For highly variable loads, larger absolute errors can occur at higher loads, where the actual percent error is the same as at a lower load point. This fact skews the root mean squared error metric (as well as standard deviations), although their accuracy on a percent basis is consistent across the measurements. Therefore, all errors were reported on a percent basis to the reference measurements.

To assess the total uncertainty of the EUT’s measurements, it was necessary to account for the uncertainty of the reference sensor (provided by the manufacturer). The total uncertainty should consider the uncertainty of the reference sensor and the estimated uncertainty of the EUT system to the reference sensors (see Eq. 2).

$$\text{Total Uncertainty}_{\text{CLES}} = \sqrt{(\text{Uncertainty}_{\text{CLES/REF}})^2 + (\text{Uncertainty}_{\text{REF}})^2} \quad \text{Eq. 2}$$

III. Demonstration Results

This section describes the quantitative and qualitative results from the field deployment. Section A presents the results for accuracy in the field. Section B presents the results for the qualitative objectives of ease of installation and ease of integration into GSA Link. Table 5 summarizes the performance objectives with its respective results.

Table 5: Performance Objectives and Results

Quantitative Objectives	Metrics and Data Requirements	Success Criteria	M&V Results
Submeter Accuracy In-Situ Field Demonstration	<ul style="list-style-type: none"> • Current • Voltage • Power • Power factor • Energy 	<ul style="list-style-type: none"> • Measurement accuracy of energy consumption (as cumulated over 2–4 weeks) of +/- 10% • Measurement accuracy of +/-10% for total power measurements⁹ • >95% data availability over the course of the demonstration 	Partial: Total energy error was <2% for all Wye loads. Delta loads showed higher errors at low power factors
Qualitative Objectives	Metrics and Data Requirements	Success Criteria	M&V Results
Ease of Installation and Integration with GSA IT/Enterprise Systems	<ul style="list-style-type: none"> • Level of technical expertise required • Time required to install and configure • Customer labor associated with install • Data integration requirements • Security requirements • Ease of visualizing and downloading data 	<ul style="list-style-type: none"> • Ability to be installed in the majority of GSA’s electrical panels • Ability to integrate into GSA Link infrastructure • Generally applicable to >70% of GSA facilities 	Met: Successfully and efficiently installed in a variety of panels. Demonstrated integration in software components of GSA Link.
Total Cost of Ownership, Value Proposition and Cost-Effectiveness	<ul style="list-style-type: none"> • Installation and O&M cost • Energy and cost savings identified • Value of tenant billing • Value of FDD 	<ul style="list-style-type: none"> • Potential savings exceeds expected installation, O&M costs • Software offers measurement and analytics capabilities that address industry needs • Data from software can be utilized to identify a sizable portion of the faults and ECMs identified by the GSA Link software (75% or more) • Determine if life cycle is cost-effective as a stand-alone platform 	Met: Technology demonstrated ability to identify relevant behavior (e.g., cycling, on/off, seasonal trends)

⁹ Evaluation of meter accuracy during laboratory testing demonstrated that comparison to stated accuracy in product literature was not appropriate for field testing success criteria. Accuracy values in product literature were developed using controlled voltage/current sources and are not reflective of in-field operation and therefore should not be the success criteria for this objective.

A. QUANTITATIVE RESULTS

SITE DEPLOYMENT

i. Objective 1 (Quantitative): Submeter Accuracy in Field Deployment

The EUT was installed in the César E. Chávez Memorial Building in Denver, Colorado. Accuracy analysis was performed on three loads in two panels (PPD-7 and LD2-7) on the 7th floor and two equipment disconnects in the penthouse. Loads that were monitored with both the EUT and the high-accuracy NREL submetering system include one fan-powered VAV, panel mains, one AC heat pump, and two centrifugal chillers.

During the field deployment, the EUT was deployed in the standard approach suggested by the vendor; each three-phase circuit was monitored with one three-phase DinRail Meter.

Results show that the EUT captured the trend of the load profile closely, even for high-variability loads. Figure 9 shows one day of measured data for the panel mains (PPD-7) and for the fan-powered VAV box, comparing reference data to EUT's data. The panel mains represent a load that does not cycle significantly, whereas the VAV system exhibits large power swings during periods when the system turns on/off. The CLASP output follows very closely the readings from the revenue-grade metering.

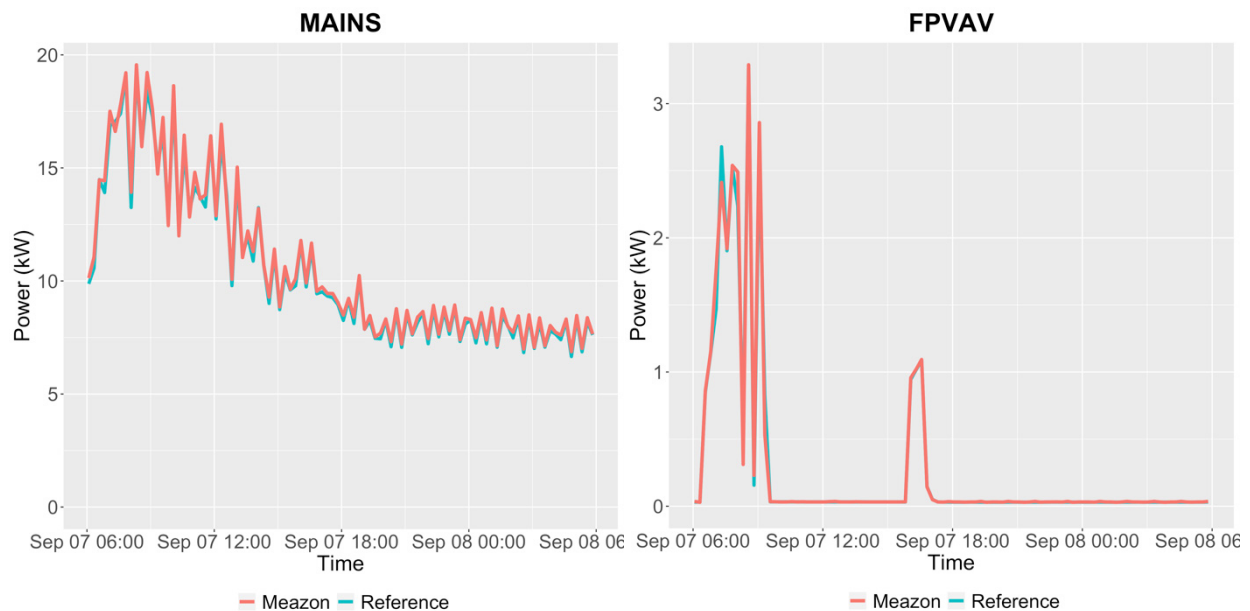

Figure 9: Representative time series data comparing measured data from the CLASP meters with NREL submetering (Reference). The figure shows the power consumption of the panel mains (left) and the VAV for one day.

The total energy error for those loads was calculated to be less than 2%. NREL calculated the RSMPE of the CLASP's readings with respect to the reference ones. RSMPE provides a normalized measure of how far the measured readings are from the reference data points (revenue-grade meter's readings). In other words, it tells you how closely the CLASP measurements track the reference ones normalized by the magnitude of the reading. For all loads, RSMPE was low (<2%). Table 6 shows the

uncertainty for all loads during September 2019. During this month, the total energy error was found to be below 2% for all loads, except for the chiller loads. The average error and RSMPE are also small for most loads. The VAV and the chillers present larger RSMPE as the loads shows high power swings due to contrasting power levels (ON vs. OFF). For the VAV, this occurs mainly due to misalignment in the data between the reference and CLASP’s meters; data streams cannot be aligned perfectly due to the 1-min resolution and asynchronous clocks. The data from the chillers were split to analyze two distinct scenarios: data when chillers are idling (≤ 2.5 kW) and all chiller data. This distinction was made due to the observation that accuracy was affected significantly when chillers were online but unloaded.

Table 6: Data Statistics for September 2019

Trial	Equipment	Range	# Points	Ref. Avg. Power (kW)	Average Percent Error (%)	RMSPE (%)	Total Energy Error (%)
1	Fan-Powered VAV	All	2,280	0.4	3.5	23.1	0.8
2	Mains	All	2,280	1.1	1.8	3.1	1.7
3	Chiller 1	All	2,280	11.7	223.7	304.8	13.8
		>2.5 kW	308	79.3	1.14	2.3	1.1
4	Chiller 2	All	2,280	15.8	190.6	293.6	9.0
		>2.5 kW	491	68.4	1	2.7	0.9

The chillers needed a closer inspection because these meters had the highest error when considering all data points. During the monitoring months, the chillers had low energy consumption due to being idle most of the time (Figure 10). Both chillers take turns meeting the demand because only one is allowed to run at any given time to operate at higher part-load ratio to increase equipment efficiency. This fact intensifies the downtime for each chiller. We expect to have higher energy consumption (and diminished idling time) during warmer months. The chillers are the only loads connected in a Delta configuration. From the measurements, NREL researchers noticed that the CLASP’s meters perform very well when the chillers are active (>2.5kW). The RMSPE and total energy error drop below 4% and 2%, respectively, if only considering the times when the chillers are operating (vs. idling). Average error and RMSPE increases significantly when the units are inactive (but online [≤ 2.5 kW]). As power consumption is small, total energy error only increases slightly and not in the same magnitude as the average error or RMSPE. The total energy error for all data points is 13.8% and 9.0% for Chiller 1 and Chiller 2, respectively.

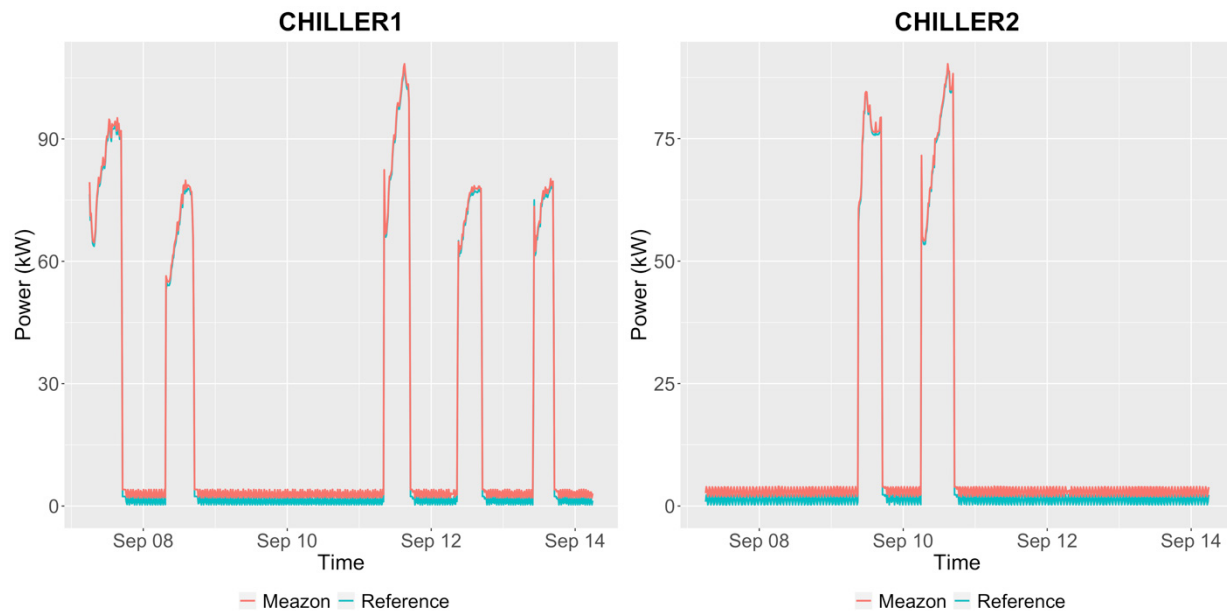

Figure 10: Chillers' power consumption for one week

All loads, except the chillers, are wired in a Delta configuration as it is ideal for large motors that do not require a neutral wire. The CLASP can monitor Delta loads but might face discrepancies when Delta-phase connection is combined with low power factor and current, which is the case during the idling periods of the chillers (see Figure 10). For all the Wye-configuration loads, the accuracy is not visibly impacted at low power factor and low currents. During the analysis period, the chillers were idle most of the time; it is possible for the error to accumulate over a month and become relevant (~10%). The CLASP manufacturers offered that there is a correlation between this behavior and the configuration type, because the ULTRA DinRail meters are designed for Wye (star) phases connection loads and might incur increased errors at low power factors and current levels. The manufacturer is currently working on new generation DinRail meters that provide improved accuracy for Delta loads. Finally, using higher accuracy CTs for Delta loads, specifically, can help mitigate this behavior.

B. QUALITATIVE RESULTS

i. Qualitative Objective 1: Ease of Installation and Integration with GSA Link System

a. Installation Summary

The circuit-level technology evaluated in this report makes it easier to meter individual loads in a panel due to small form factor components (e.g., CTs and bridge), wired CTs and bridge, and preconfigured cloud-hosted data storage. However, the most appropriate scenario would be to monitor specific loads or panel mains, as each three-phase load requires an additional meter. The single-circuit technology features a standard approach for metering loads: wired split-core CTs and voltage taps. The technology is applicable for any standard electrical panel, and can also be used to monitor large device disconnects.

Installation of the CTs requires the opening of the electrical panel cover and, therefore, requires a licensed electrician for the install (per applicable safety and contracting requirements). During the installation for this technology demonstration, the entire installation was able to be performed without de-energizing the panel because disconnecting a single breaker was sufficient.

Once the CTs are installed, a straightforward process is required to associate the unique identifier associated with each sensor to its location within the electrical panel. This creates a mapping from the individual sensor to the specific load/phase that it is metering, and generates associated metadata that the web interface uses to provide insight, analytics, and rules/alerts.

To transport the data from the single-circuit bridge to the cloud-hosted data storage, one can use the built-in ethernet jack, Wi-Fi, or cellular (3G GSM) communications. There is a SIM card slot in the CLASP's bridge, and this can be used to connect to optional cellular connections. Due to the pilot nature of this technology demonstration, it was desirable to use cellular communication and avoid connecting to the building ethernet. This was primarily due to project timeline considerations because there was a lengthy cybersecurity review and approval process for connecting a new device to the LAN. The initial cyber review did not flag any concerns with the device and allowed installation for the pilot project with cellular communications.

The installation of the meters at the César E. Chávez Memorial Building comprised 3 separate CLASP bridges that collected data from 18 individual CTs, distributed in two panels and two HVAC equipment disconnects. The installation took place in one day and required six hours of a single electrician. The meters were preconfigured by the CLASP's distributor, Madison Electric Inc., who set up three electrical boxes; each with two CLASP's meters and one breaker disconnect. The breaker was not required but installed for convenience and safety. The final setup on each meter box is shown in Figure 5. The preconfiguration step streamlined the installation process and permitted minimal space requirements inside the electrical panel; this configuration only requires the cable connections and the CTs inside the panel.

There were no significant challenges with the installation because there was no need to mount electrical boxes (as in the case of the reference meter). As noted, this installation used 3G cellular to transport the data from the bridge to the cloud using the built-in cellular capabilities and antenna provided by the CLASP's bridge. The 3G cellular approach enabled a streamlined pilot project timeline and required minimal additional labor hours. However, a monthly cell subscription was needed for data transmission during the length of deployment. This will not be required when ethernet drops are available for the meters to connect into directly. Within a few days after the installation, the metered data was available for visualization, downloading, and analysis via the web-based user interface or the API.

The technology has been designed and is advertised as a stand-alone system for data analytics and reporting. However, the technology can be integrated with GSA Link, a system that connects the building management system to a central cloud-based platform using SkySpark.¹⁰ During the accuracy verification analysis, NREL pulled data through the vendor's API and uploaded it to an NREL

¹⁰ SkySpark is a platform for storing, visualizing, and analyzing building information data. <https://skyfoundry.com/>

SkySpark server for data storage, processing, and analysis. This demonstrates that a similar approach is viable to work with the GSA Link system. The only significant challenge is expected to be ensuring firewall exception requests to be able to access the web-hosted data storage via the supplied API. With the API documentation, NREL engineers developed a stand-alone Python script, based on an example provided by the vendor, which can communicate with the CLASP API and store the data locally to be later uploaded into GSA Link or other analytics platforms.

Additionally, the vendor also offers a data analytics platform that can be leveraged directly without the need to use the GSA Link platform. This can provide energy savings strategies, fault diagnostics, and data visualization (e.g., charts and trends) for buildings without a BAS. NREL did not verify the capabilities or effectiveness of those features.

C. TOTAL COST OF OWNERSHIP AND COST-EFFECTIVENESS

i. Qualitative Objective 2: Value Proposition and Cost-Effectiveness Analysis

The metering technology permits multiple value propositions, as shown in Figure 2. NREL collected manufacturer information to estimate the total cost of ownership. This will prove useful in understanding the value proposition of the technology once specific cases have been identified. An extensive cost-effective analysis of the technology was outside the scope of this project. No ECMs were identified using the CLASP, but it is very likely that the technology can be leveraged for that purpose. The loads monitored during this deployment were not used for overtime utilities. However, it can be shown that the accuracy meets standards to provide those services.

a. Total Cost of Ownership

The total cost of ownership includes labor (e.g., installation and commissioning), capital costs (e.g., meters), and operation expenses. NREL calculated the total cost for the pilot deployment from information provided by the vendor (see Table 7 and Table 8). The cost of the CLASP decreases significantly if equipment is purchased in larger quantities. Thus, it was calculated what the per-point price is at those larger volumes as well.

Table 7: Per-Point Cost for Pilot Pricing

Category	Equipment	Quantity	Unit Cost	Total
Meter + CTs	D-Rail ULTRA Meter 400A (200–285 VAC)	1	\$398.2	\$398.2
	D-Rail ULTRA Meter 63A (200–285 VAC)	1	\$213.4	\$213.4
	D-Rail ULTRA Meter 63A (100–240 VAC)	2	\$213.4	\$426.8
	D-Rail ULTRA Meter 600A (200–285 VAC)	2	\$395	\$790
Gateway	Meazon Janus	3	\$330	\$990
Total Cost (Parts Only)				\$2,818.4
Per-Point Cost (Parts Only)				\$470

Table 8: Total Cost of Ownership for Pilot Deployment

Category	Description	Company	Cost
Parts	Meazon meters, gateways	Meazon	\$2,818
Preconfiguration	Configure meter, breaker into electrical box	Madison Electric	\$2,140
Electrical Installation	Electrician work: install meters already preconfigured	Ventura Electric, Inc.	\$450
Operation Cost	Subscription fees	N/A	\$0
Total Cost			\$5,408
Per-Point Cost (Parts + Installation)			\$901
Per-Point Cost (Parts Only)			\$470

The previous cost shows the per-point cost for the pilot project. However, cost of equipment can significantly be lowered if equipment is purchased in large volumes. Table 9 shows per-point cost if large units of equipment were purchased; at least 1,000 meters and at least 100 gateways are required for the lower price. Fifteen meters per gateway is used in the analysis because that is the maximum number of meters compatible with a single gateway. The data can be visualized from the gateway browser at no extra cost.

Table 9: Per-Point Cost for Larger-Volume Pricing

Category	Equipment	Quantity	Unit Cost	Total
Meter (>1,000 units)	D-Rail ADVANCED Meter	15	\$89	\$1,335
CTs	CT	45	\$11	\$495
Gateway (>100 units)	Meazon Janus	1	\$150	\$150
Total Cost (Parts Only)				\$1,980
Per-Point Cost (Parts Only)				\$132

b. Identification of ECMs

Identification of ECMs was not included in this project, but the capabilities of the system that enable identification of ECMs is covered below. The vendor also provided an advanced internet-of-things (IoT) platform smart building service that can combine other type of sensors in multi-site distributed architectures. Screenshots of the dashboard and analytics platform are included in Appendix V.B. Pricing for this type of service depends on specific customer needs and ranges from \$12 to \$48 per meter per year, depending on requested service features. From the high-resolution data from the meter, GSA staff can identify cycling behavior (see Figure 11), determine when loads are turned on or off, and monitor if loads are working properly and in the right schedule. Figure 10 clearly shows that both chillers operate at separate times to achieve higher efficiency by avoiding running both chillers at low part-load ratio. The accurate and high-resolution (1-min) data can provide visibility into the energy consumption patterns, identify potentially inefficient device operation, and identify opportunities to reduce energy.

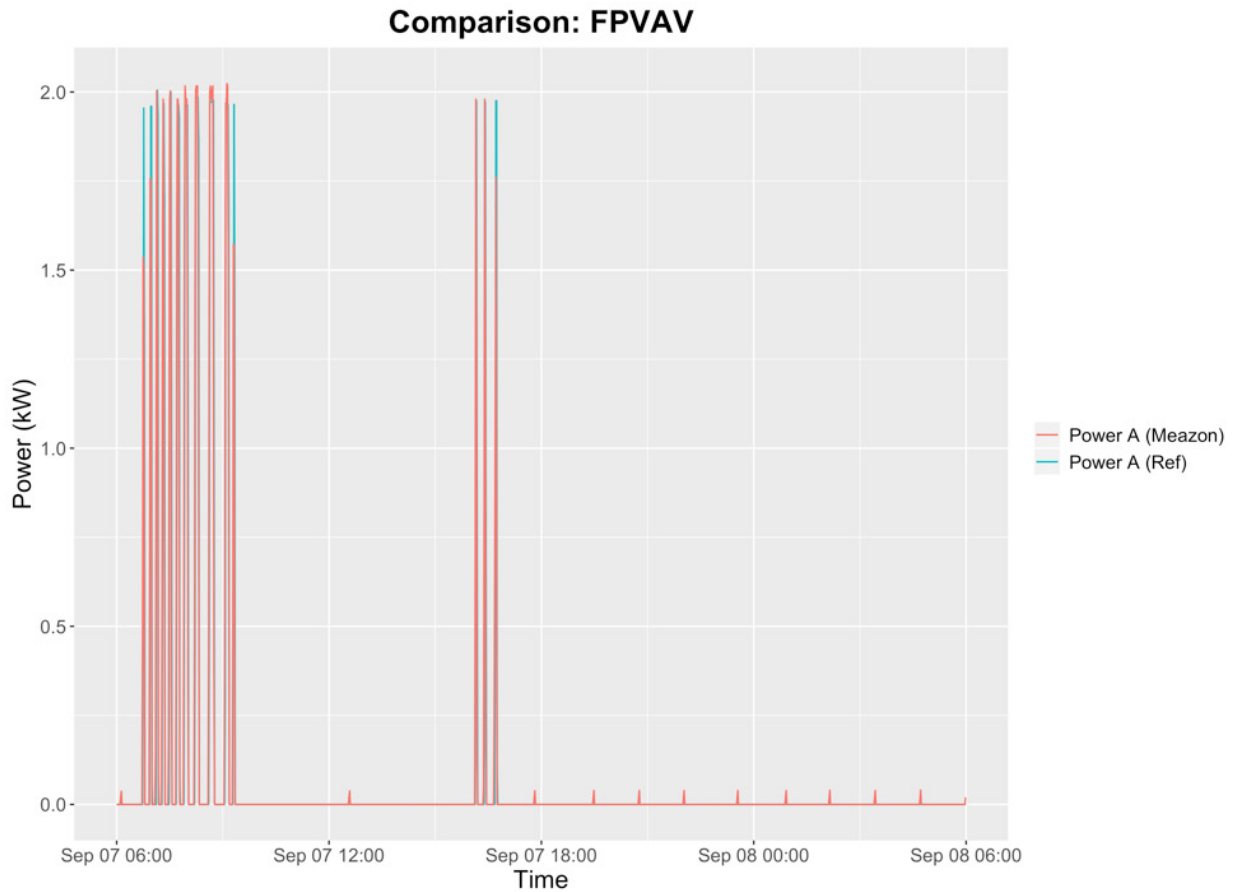

Figure 11: Fan-powered VAV (FPVAV) cycling behavior (1-min data)

c. Overtime Utility Billing

The loads instrumented during the deployment did not incur in overtime utilities, and a cost-effectiveness analysis was outside the scope of this project. Nonetheless, the results clearly show the CLASP’s ability to satisfactorily calculate energy consumption for all loads in the deployment.

IV. Summary Findings and Conclusions

A. OVERALL TECHNOLOGY ASSESSMENT AT DEMONSTRATION FACILITY

Installation of the CLASP technology at the César E. Chávez Memorial Building successfully met most, but not all, of the performance objectives laid out in the demonstration plan. The system met the data completeness expectations during the field evaluation, as the meters did achieve a 95% data transmission rate; the system suffered from data loss (~5%) due to communication problems or interference. The system exceeded expectations for accuracy for the Wye configuration (but not for Delta loads) and the ease of integration with existing GSA enterprise systems, such as GSA Link.

Three primary goals for studying this technology were to assess:

1. Accuracy, resolution, and reliability of the data to provide tenant billing services;
2. Ease of installation, data retrieval, and integration with legacy systems (e.g., GSA Link); and
3. Total cost of ownership of the system (including meters, gateway, and any required recurring costs to be able to access metered data).

For the Wye configuration, the meters successfully met all predefined goals. The accuracy targets were met, as the system's measurements differed by less than 2% from the revenue-grade meter's readings. It was demonstrated that data automatically downloaded from the vendor's API can be integrated into the primary software component on the GSA enterprise-level energy management and information system, GSA Link. The CLASP's meters did not meet the accuracy requirements for the chillers. They were wired in a Delta configuration and the meters did not perform well at low power factor levels (idling of the chillers). Despite that, the system tracked the load closely when the chillers were running. The EUT can provide accurate power readings cost-effectively, as no subscription fee is required to access the meter data.

The demonstration of EUT data integration expands the opportunities for FDD across the GSA portfolio.

- For buildings with an existing GSA Link deployment, this would enable the monitoring of additional end uses.
- For buildings that do not have GSA Link deployed, the GSA SkySpark platform could be used with the single-circuit data. This would provide an FDD capability for these buildings (albeit with reduced functionality) without full BAS integration and GSA Link deployment.
- Finally, this approach would deliver FDD functionality for buildings where a centralized BAS does not exist, enabling FDD for a set of GSA buildings that would not have this capability otherwise.

Overall, we conclude that the EUT can provide insightful high-resolution data as outlined in the performance objectives. With this information, the building manager can (1) identify ECMs leading to measurable savings and (2) address identified ECMs, thereby reducing the utility costs and saving energy.

B. LESSONS LEARNED AND BEST PRACTICES

The key lessons learned during this demonstration include the following:

- It is critical to independently verify the installation and configuration of the meters to ensure the intended operation. Errors at this stage are increasingly more difficult to correct as time progresses.
 - During the deployment, the installation work was not verified after the installation; the electrician replaced the panel dead front before independent verification could be performed. An unexplained discrepancy was identified between the reference and the CLASP's measurements for one of the loads. The discrepancy could be attributed to installation errors. The reference meters were removed before that

discrepancy was analyzed and addressed. Therefore, a determination could not be made for the discrepancy, and the load was removed from the analysis.

- Preconfiguration by a technology distributor saves time and ensures modular installation. The enclosure saved space inside the panel and allowed for debugging and troubleshooting later, because it does not require the electrical panels to be opened to visualize the meters. However, care must be exercised to ensure proper installation.
 - The original plan was to meter the 7th floor server load and the AC equipment conditioning that unit to calculate power usage effectiveness. The AC equipment and the server were powered from different electrical rooms. The CLASP's distributor preconfigured the meters for the server circuits and the AC equipment in the same physical enclosure (Figure 5), which made it impossible to realize the desired configuration. Thus, the CLASP's meter was repurposed to monitor a different server load. As a result, this configuration made it impossible to calculate the servers' power usage effectiveness.
- The meter closely tracks power consumption for loads in the Wye configuration in par with revenue-grade metering. However, there were some discrepancies at low power factors (idling equipment) for the Delta configuration. The vendor recommends opting for its new meters for this specific configuration to address that issue. **The manufacturer stated that the new FCC certified Cerberus DinRail meter can measure DELTA loads with same accuracy as Y loads in low-power factors and powers.**
- Access to and utilization of the data can be achieved either through the native user application provided by the vendor or by API access. The API access enables integration of the data with marginal effort into existing analytics platforms, such as GSA Link.
- Identification of the circuits for observation can be a time-intensive process. It is important to have clear goals as to the site's monitoring objectives before deployment.
- If using a single CT on three-phase equipment, the load should be well balanced. This could be achieved through knowledge of the specific load or spot check of amperage.
- It is not always easy or possible to clearly identify which loads are associated with which circuits. This can result from inaccurate panel schedules, obscure naming conventions, or lack of circuit tracing. This is important to consider when trying to isolate monitoring to a specific tenant, space, or set of devices. Circuit tracing can be executed to match all loads to panel circuits, though this may be an expensive process for locations with many low-load receptacles.
- A registered electrician will be required to install the system per site safety requirements. Special attention should be given to the installation of the voltage tap, where required.

C. DEPLOYMENT RECOMMENDATIONS

The EUT system was installed in an existing building. However, it could have been implemented in new construction just as easily. The acquisition system is flexible and allows single or three-phase panels, multiple voltage configurations (e.g., 120 V, 240 V, or 480 V), and power levels with non-proprietary CTs (available from multiple manufacturers and with different accuracy ratings). The CLASP can potentially do full panel readings (42+ circuits), because multiple CLASP meters can be

used in a modular manner using one wireless gateway to transmit data to the monitoring application. However, this might be not practical (or even feasible) as the configuration requires one meter per 3-phase circuit. The CLASP is best suited for large consumption devices (e.g., chiller) or critical ones for metering, FDD, or energy visibility because they can report data down to per-second level using wireless Zigbee communication.

The bridge collects sensor information at fast rates and must be installed in the vicinity of the panel box to ensure smooth communication and avoid package drops. Also, line of sight was important to ensure reliable communication between the wireless meters and the gateway even if both pieces of equipment were in the same electrical room. We recommend installing only one bridge per electrical room to serve all meters in short distances. This will ensure minimum interference between other equipment. Furthermore, the bridge requires strong Wi-Fi or cell signals to avoid package drops and missing readings. Heavy concrete construction, metal enclosures, and interference from other wireless sources could reduce signal strength. If the signal is weak, NREL recommends installing an extender for Wi-Fi and choosing a wireless carrier that provides a strong signal in the case of cell coverage. While the connection to the LAN will entail cybersecurity approval (and associated challenges), this would, in theory, provide the most reliable delivery of data from the meter to its cloud-storage database.

To decrease measurement uncertainty, it is recommended to size CTs to estimated power levels (if possible), as opposed to rated breaker values. This may be achieved by metering current with a clamp ammeter or understanding the equipment ratings served by that breaker to estimate amperage draw and effectively size the CT accordingly. Caution should be exercised to avoid undersizing the CT because it might lead to inaccurate readings and, eventually, a damaged CT. The vendor recommended installing higher-accuracy CTs for error-sensitive applications. The incremental cost of those CTs is only about 10% more.

The CLASP has applicability throughout the GSA portfolio. It will provide the most value where specific devices or end uses can be identified as requiring accurate power data at a low cost. For example, devices with high power consumption, devices with uncertain schedules, and tenant-owned equipment (specifically those operating 24/7) are all scenarios where this technology will deliver significant insight and has the potential to drive more significant savings. Additionally, loads and devices that are not integrated into the BAS may be worth considering for monitoring via this technology. It provides the capability to apply FDD to those systems where typically they are not monitored on an ongoing basis.

V. Appendices

A. MANUFACTURER CUT SHEET

Table 10: Meazon DinRail Three-Phase ULTRA¹¹

Category	Description
Architecture	ZigBee Mesh Network
Frequency band	2.4 GHz
Minimum data communication interval	1 second (default 5 min)
Operating voltage / frequency (model depended)	100–240 VAC / 45–65 Hz 200–285 VAC / 45–65 Hz
Ranges of measured parameters (model depended)	Voltage: 0–240 VAC phase-to-neutral, 45–65 Hz Voltage: 0–285 VAC phase-to-neutral, 45–65 Hz Current: up to 600 amperes
Electric parameters measured	I_{rms} , V_{rms} , frequency, active power and energy, reactive power and energy
Build-in data log record	25 days
Dimensions	27.8 x 80 x 59.6 mm (WxHxD)
Security	AES encryption 128 bits

¹¹ Specifications obtained from documents provided by Meazon.

B. USER INTERFACE

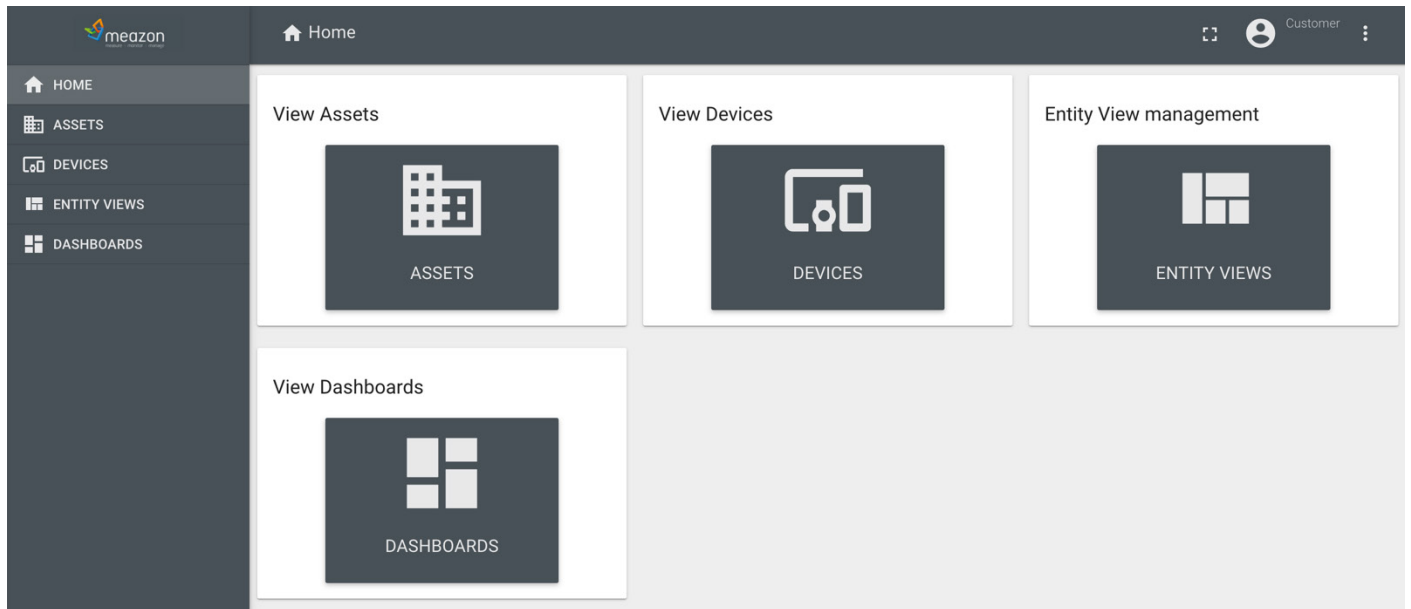

Figure 12: GUI home

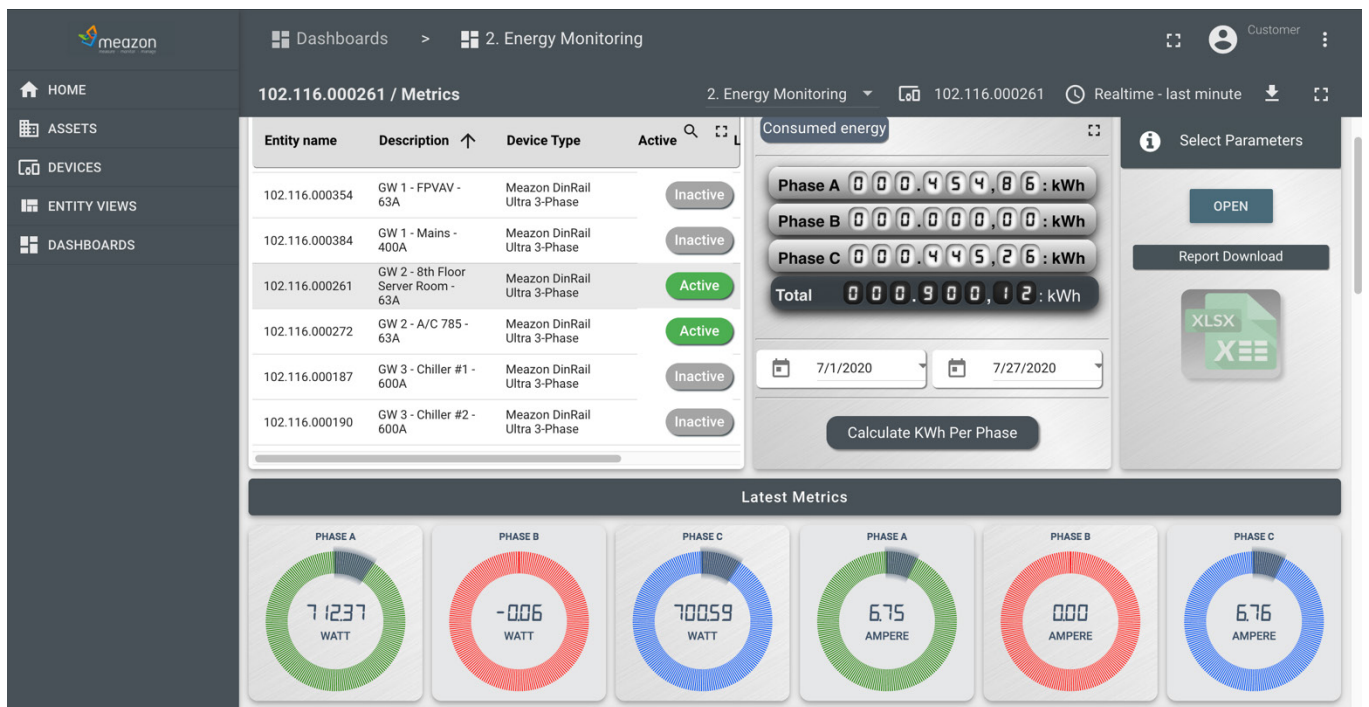

Figure 13: Energy monitoring dashboard

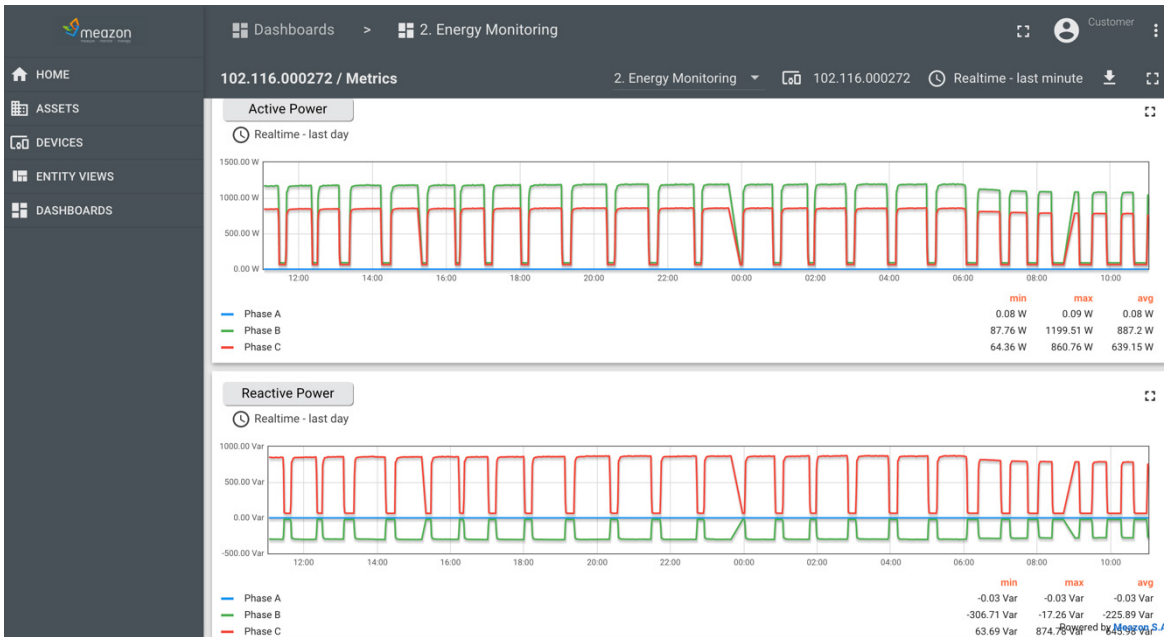

Figure 14: Energy monitoring dashboard: daily power consumption (AC785)

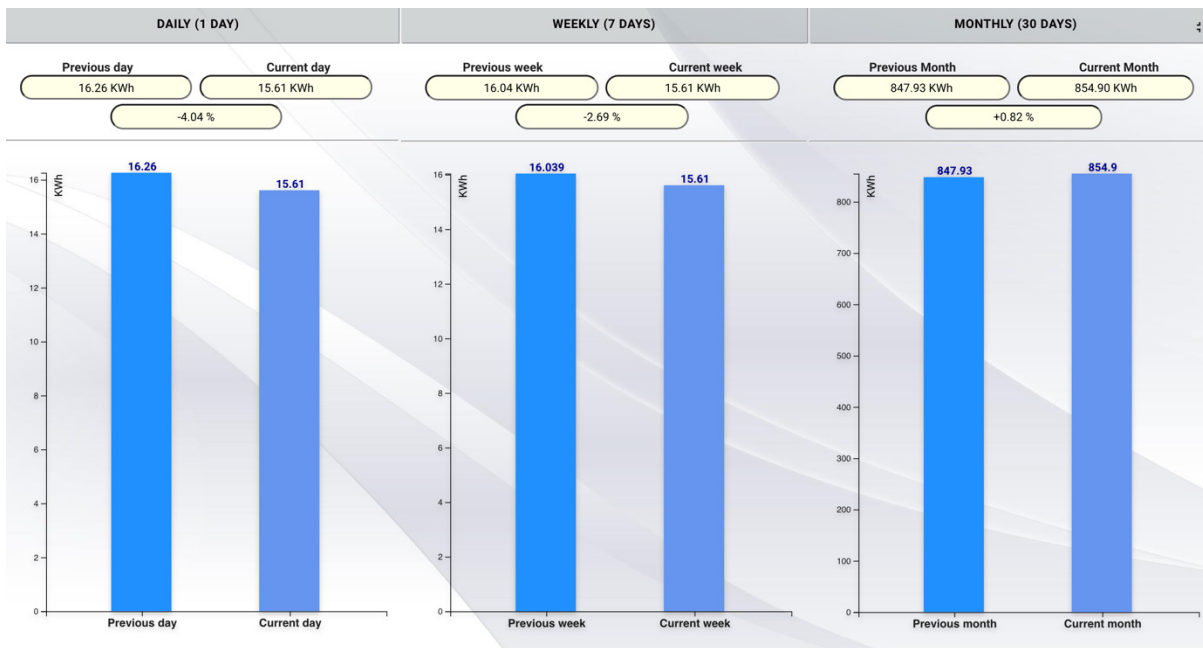

Figure 15: Analytics dashboard: energy consumption at different timescales (AC785)

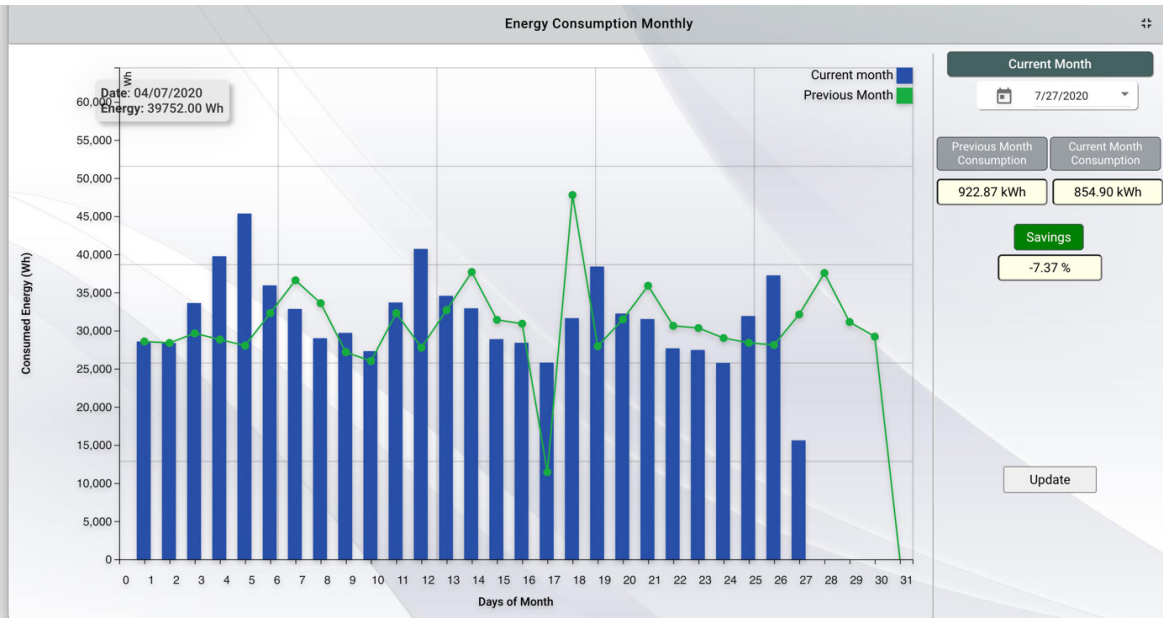

Figure 16: Analytics dashboard: daily energy consumption (AC785)

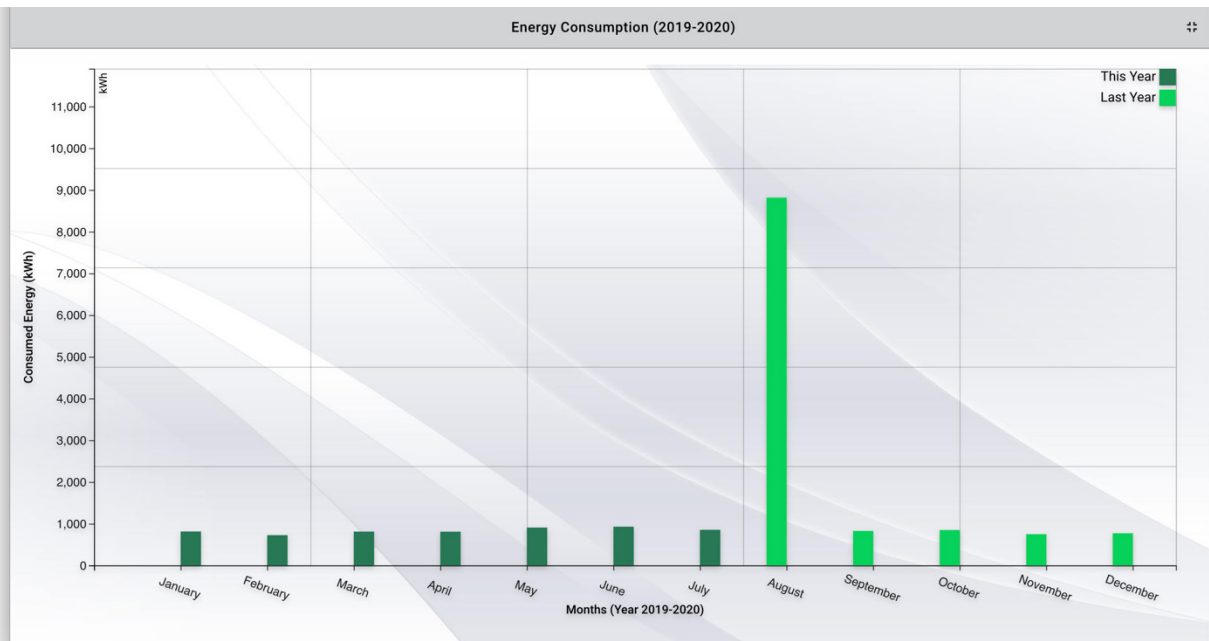

Figure 17: Analytics dashboard: monthly energy consumption (AC785)