



Prepared for the General Services Administration
By the National Renewable Energy Laboratory



NOVEMBER 2021

Demonstration and Evaluation of Lightweight High Performance Secondary Windows

Kosol Kiatreungwattana (NREL)

Lin Simpson (NREL)

Disclaimer

This document was prepared as an account of work sponsored by the United States Government. While this document is believed to contain correct information, neither the United States Government nor any agency thereof, nor the National Renewable Energy Laboratory, nor any of their employees, makes any warranty, express or implied, or assumes any legal responsibility for the accuracy, completeness, or usefulness of any information, apparatus, product, or process disclosed, or represents that its use would not infringe privately owned rights. Reference herein to any specific commercial product, process, or service by its trade name, trademark, manufacturer, or otherwise does not constitute or imply its endorsement, recommendation or favoring by the United States Government or any agency thereof, or the U.S. Department of Energy's National Renewable Energy Laboratory. The views and opinions of authors expressed herein do not necessarily state or reflect those of the United States Government or any agency thereof or the National Renewable Energy Laboratory.

The work described in this report was funded by the U.S. General Services Administration and the Federal Energy Management Program of the U.S. Department of Energy under Contract No. IAG-11-01815.

Acknowledgements

U.S. General Services Administration (GSA) Region 8: Tyler Cooper, Douglas Baughman

GSA Proving Ground Program: Michael Lowell and Kevin Powell

Alpen High Performance Products: Brad Begin, Craig Maierhofer, Robert Clark, Dwayne Kowaliuk

National Renewable Energy Laboratory: Kosol Kiatreungwattana, Lin Simpson, Jesse Dean

Mountain Energy Partnership: Ed Hancock, Greg Barker and Paul Norton

Tenfold Information Design Services: Andrea Silvestri

For more information contact:

Michael Lowell

General Services Administration

Email: mike.lowell@gsa.gov

NREL/TP-5R00-79112

Executive Summary

This demonstration project assessed the thermal performance, life cycle costs, and deployment potential of two types of window inserts, or “secondary windows,” to be used in conjunction with existing, older single-pane windows.

A. BACKGROUND AND OVERVIEW OF THE TECHNOLOGY

The U.S. Department of Energy’s (DOE) National Renewable Energy Laboratory evaluated the secondary windows at the U.S. General Services Administration’s (GSA) Denver Federal Center Building 53 in Denver, Colorado. For this study, ten secondary windows (single-pane and double-pane secondary windows) were installed at Building 53.

Several different evaluations assessed the viability of the secondary windows for GSA applications. Some of these assessments were performed with models, while others required onsite evaluations including time series measurements.

B. STUDY DESIGN AND OBJECTIVES

The primary objectives of the onsite measurement and verification study include:

Objective 1. Verify the benefits of the high performance secondary windows, including:

- a. Thermal performance
- b. Heating, ventilating and air conditioning (HVAC) energy reduction
- c. Thermal load (cooling and heating) reduction
- d. Comfort improvement

Objective 2. Economic analysis (savings to investment ratio [SIR] and payback)

Objective 3. Evaluate ease of installation and operability

Objective 4. Assess the deployment potential for other GSA sites and identify screening criteria for future candidate buildings and climate zones.

Quantitative objectives and results are provided in Table ES-1 and qualitative performance objectives for the project are provided in Table ES-2.

Table ES-1: Quantitative Objectives and Results

Quantitative Objectives	Metrics & Data	Success Criteria	Results
Energy Savings	HVAC energy consumption (modeled), kBtu	Energy savings compared to single-pane window baseline 10% for HVAC energy usage	HVAC energy savings compared to single-pane window baseline Single-pane secondary <ul style="list-style-type: none">• 20% savings Double-pane secondary <ul style="list-style-type: none">• 40% savings

Quantitative Objectives	Metrics & Data	Success Criteria	Results
Thermal Performance Indices	U-values, Btu/h-ft ² ·°F Solar heat gain coefficient (SHGC), % Visible transmittance (VT), %	Field installed window within 20% of National Fenestration Rating Council (NFRC) rated values/manufacturer's claims	Single-pane secondary <ul style="list-style-type: none"> • U-value 17% lower • SHGC 5% lower • VT 10% greater Double-pane secondary <ul style="list-style-type: none"> • U- value 30% lower • SHGC 16% greater • VT 1% greater
HVAC Capacity Reduction	HVAC cooling capacity (modeled), kBtu/hr HVAC heating capacity (modeled), kBtu/hr	HVAC capacity ^a reduction compared to a single-pane window baseline 10% for HVAC cooling and heating loads	Single-pane secondary window <ul style="list-style-type: none"> • 10% for heating capacity • 8% for cooling capacity Double-pane secondary <ul style="list-style-type: none"> • 19% for heating capacity • 13% for cooling capacity
Cost-Effectiveness	Simple payback, years SIR, no unit	< 15 years payback > 1 SIR	Simple payback / Savings-to-investment ratio Single-pane secondary <ul style="list-style-type: none"> • 18.3 yr • 1.1 SIR Double-pane secondary <ul style="list-style-type: none"> • 10.7 yr • 1.9 SIR
Condensation	Room-side glass surface temperature, °F Relative humidity, % Calculated Condensation Resistance (CR) rating, 0-100	Condensation Resistance (CR) rating greater than 50	Condensation Resistance (CR) rating Single-pane Secondary with baseline <ul style="list-style-type: none"> • 44 CR Double-pane Secondary with baseline <ul style="list-style-type: none"> • 46 CR CR rating for the existing single-pane window is low at 12-14 due to the fact that it has inferior thermal performance. Although the criteria was not met, the secondary windows still improved overall condensation rating significantly.

Quantitative Objectives	Metrics & Data	Success Criteria	Results
Thermal Comfort	Space temperature, °F and relative humidity, %	Space temperature and relative humidity are within occupant thermal comfort defined by ASHRAE Standard 55-2013	Both secondary windows
	Room side glass surface temperature, °F		A small number of hours (5 to 10%) that were outside the comfort boundary
	Wall temperature, °F		

^a HVAC capacity for potential HVAC sizing reduction.

Table ES-2: Qualitative Objectives

Qualitative Objectives	Metrics & Data	Success Criteria	Results
Thermal Comfort	Tenant satisfaction survey	Improvement in tenant satisfaction with thermal conditions	Building 53 for secondary window Five surveys received; 3/5 were positive and recommended the retrofit. 2/5 did not have any opinion on the retrofit.
			Thermal discomfort occurred and may be caused by HVAC rather than the windows. Secondary window appearance was noticeable but acceptable.
Ease of Installation	Interview with installer	<1 day to install	Installation of a secondary window, by one person, took approximately 7–10 minutes to install. It could be easily installed and uninstalled.
	Labor associated with install		

The demonstration assessed the use of secondary windows for GSA applications. Several different evaluations assessed the viability of the secondary windows for GSA applications. Some of these assessments were performed with models, while others required onsite evaluations including time series measurements.

C. PROJECT RESULTS AND FINDINGS

The secondary windows operated as intended and most evaluation criteria were met. The secondary windows provide energy savings and are cost effective due to improved thermal performance.

Results, findings, and conclusions are summarized below.

- The secondary window can be quickly and easily installed with existing windows to provide a cost-effective and efficient way to improve thermal performance and occupant comfort, especially when integrated with existing single-pane windows. The quick installation—compared to the process of replacing primary windows—minimizes disruption to the building occupants.

- The secondary window can be a much less expensive alternative to replacing primary windows. In addition, the secondary windows are lightweight and thus suitable for structures that cannot handle additional weight.
- The technology is particularly useful in buildings or areas where planning rules do not allow any aesthetic changes to the external primary windows (e.g., historic buildings).
- Windows with the same U-value are manufactured with various levels of SHGC. SHGC should be appropriately selected for a climate zone. The lower the SHGC, the less solar heat it transmits and the greater its shading ability. A product with a high SHGC rating is more effective at collecting solar heat during the winter. A product with a low SHGC rating is more effective at reducing cooling loads during the summer by blocking heat gain from the sun.
- The calculated CR for the secondary window integrated with a baseline single-pane window is 44–46. By a narrow margin, they did not pass the criteria. This shortfall may not necessarily be attributable to the secondary window, but rather to the existing single-pane window. Integration of the secondary window substantially improved CR as compared to the existing single-pane window, which has a CR rating of 12–14 due to its inferior thermal performance. A CR over 50 indicates good condensation resistance.
- Other studies suggest that secondary windows can significantly reduce air infiltration, resulting in additional energy savings.
- The thermal comfort criteria are met as the results show that the majority of the indoor conditions were within the comfort boundary. However, the predicted mean vote and percentage of dissatisfied analysis shows that the space in Building 53 was slightly cool and predicts that 45% of the occupants could experience some local thermal discomfort. It is possible that thermal discomfort was already present and was caused by HVAC operation rather than the windows.
- Measured temperatures at the center of the glass during the coldest period show significant improvement due to the secondary window. The average temperatures at the center of the glass of double-pane and single-pane secondary windows during cold periods (mean outdoor temperature of 21°F) are 68.2°F and 56.7°F, respectively, compared a baseline single-pane window at 48°F. Temperature differences increase radiant asymmetry, which contributes to occupant discomfort. ASHRAE 55 guidelines state that for vertical surfaces, radiant asymmetry should be kept to less than 18°F (ASHRAE 2020). Within this demonstration, the vertical-surface radiant asymmetry of the double-pane and single-pane secondary windows are within the ASHRAE guidelines. In addition, larger temperature differences between the window surface and indoor air can also induce convective heat transfer through air movement, particularly during cold conditions. Drafts caused by air movement can also contribute to occupant discomfort.
- Most thermal comfort survey responses were positive and recommended the secondary window retrofit in the future. The secondary windows' appearance was noticeable but acceptable.
- To evaluate deployment potential, we conducted energy savings and economic analyses through energy simulation modeling for ten ASHRAE climate zones (1A to 6A). The energy cost was estimated for three levels of GSA utility rates (low, medium, and high). Criteria include a payback period of less than 15 years and a SIR greater than 1 for both secondary windows. The results populated in Table 38 of this report can be used for future screening for the technology. However, for a future retrofit project, a detailed study including energy modeling analysis of the window options for the specific building is recommended due to the fact that each building is unique. Results and findings are summarized below.

Single-Pane Secondary Window

Estimated Heating Energy (1)

- Heating energy reduction between 24% and 38%
- Normalized heating energy savings from 0.4–7.6 kBtu/ft²/yr

Estimated Cooling Energy (2)

- Cooling energy reduction between 6% and 10%
- Normalized cooling energy savings from 0.3–1.0 kBtu/ft²/yr

Estimated Fan Energy (3)

- Fan energy reduction between 8% and 12%
- Normalized fan energy savings from 0.6–1.2 kBtu/ft²/yr

Estimated HVAC Energy (1+2+3)

- HVAC energy reduction between 8% and 20%
- Normalized HVAC energy savings from 1.9–8.8 kBtu/ft²/yr

Estimated Total Building Energy

- Total building energy reduction between 3% and 10%
- Normalized fan energy savings from 2.0–8.9 kBtu/ft²/yr

Estimated Total Building Energy Cost and Economics

- Normalized building energy savings:
 - \$0.04–\$0.08/ft²/yr for low utility rate
 - \$0.06–\$0.12/ft²/yr for medium utility rate
 - \$0.09–\$0.18/ft²/yr for high utility rate
- Payback period:
 - 21.9–44.6 years for low utility rate
 - 15.5–30.9 years for medium utility rate
 - 10.1–19.5 years for high utility rate
- SIR:
 - 0.4–0.9 for low utility rate
 - 0.6–1.3 for medium utility rate
 - 1.0–2.0 for high utility rate

Double-Pane Secondary Window

Estimated Heating Energy (1)

- Heating energy reduction between 43% and 94%
- Normalized heating energy savings from 1.0–13.6 kBtu/ft²/yr

Estimated Cooling Energy (2)

- Cooling energy reduction between 16% and 26%
- Normalized cooling energy savings from 0.9–2.7 kBtu/ft²/yr

Estimated Fan Energy (3)

- Fan energy reduction between 21% and 28%
- Normalized fan energy savings from 1.6–2.9 kBtu/ft²/yr

Estimated HVAC Energy (1+2+3)

- HVAC energy reduction between 21% and 40%
- Normalized HVAC energy savings from 5.7–17.0 kBtu/ft²/yr

Estimated Total Building Energy

- Total building energy reduction between 8% and 20%
- Normalized fan energy savings from 5.7–17.0 kBtu/ft²/yr

Estimated Total Building Energy Cost and Economics

- Normalized building energy savings:
 - \$0.11–\$0.18/ft²/yr for low utility rate
 - \$0.16–\$0.26/ft²/yr for medium utility rate
 - \$0.26–\$0.41/ft²/yr for high utility rate
- Payback period:
 - 12.5–20.4 years for low utility rate
 - 8.8–14.1 years for medium utility rate
 - 5.7–8.9 years for high utility rate
- SIR:
 - 1.0–1.6 for low utility rate
 - 1.4–2.3 for medium utility rate
 - 2.2–3.5 for high utility rate

Significant thermal improvements and smaller incremental costs of the double-pane secondary window as compared to the single-pane secondary window make the double-pane secondary window a good choice for future deployment in most climates. However, additional analysis indicated that the single-pane secondary window with low SHGC provided slightly better economic results than the double-pane secondary window at the same low SHGC for warm climates such as climate zone 1A. Therefore, the single-pane secondary window with low SHGC could also be a cost effective measure, particularly for warm climate zones.

Table of Contents

EXECUTIVE SUMMARY	III
I. INTRODUCTION	1
A. Problem Statement	1
B. Opportunity	1
C. Technology Description	1
D. Research Opportunity	2
II. EVALUATION PLAN	3
A. Evaluation Design	3
B. Instrumentation Plan	6
III. DEMONSTRATION RESULTS	10
A. Monitoring Activities	10
B. Quantitative Results	17
C. Qualitative Results	30
IV. SUMMARY FINDINGS AND CONCLUSIONS	47
REFERENCES	49
Appendix A - Details of Secondary Windows	51
Appendix B - Secondary Window Weight Comparison	52
Appendix C - AERC Air Leakage Testing Results of Single- and Double-Pane Secondary Windows	53
Appendix D - Infrared Thermography Field Measurements	58
Appendix E - EnergyPlus Modeling Assumptions	61
Appendix F - Comfort Survey	63
Appendix G - Additional Results for Medium Office	66

List of Tables

Table ES-1: Quantitative Objectives and Results.....	iii
Table ES-2: Qualitative Objectives.....	v
Table 1: U.S. Annual Commercial Building HVAC and Window-Related Energy Use, Reported in Quadrillion BTUs of Primary (Source) Energy.....	3
Table 2: Quantitative Objectives.....	5
Table 3: Qualitative Objectives.....	6
Table 4: Monitoring Points and Instrumentation.....	9
Table 5: Monitoring and Instrumentation Schedules.....	10
Table 6: Window Performance Indices Calculated Using WINDOW.....	15
Table 7: EnergyPlus Results for Large Office Baseline.....	16
Table 8: Quantitative Objectives and Results – Energy Savings.....	17
Table 9: Estimated Annual HVAC Energy Savings.....	18
Table 10. Quantitative Objectives and Results – Thermal Performance Indices.....	18
Table 11: Calculated Thermal Performance Indices.....	19
Table 12: HVAC Capacity Cost.....	19
Table 13: Quantitative Objectives and Results – HVAC Capacity Reduction.....	20
Table 14: Estimated HVAC Capacity Reduction.....	20
Table 15: Window Costs.....	21
Table 16: GSA Utility Rates.....	21
Table 17: Quantitative Objectives and Results – Cost Effectiveness.....	21
Table 18: Cost Effectiveness – Simple Payback and Savings-to-Investment Ratio.....	22
Table 19: Quantitative Objectives and Results – Condensation.....	22
Table 20: Window Performance Ratings Calculated Using the WINDOW Model.....	23
Table 21: Inputs to the CBE Thermal Comfort Tool.....	23
Table 22: Quantitative Objectives and Results – Thermal Comfort.....	27
Table 23: Average Surface Temperature During Cold Period.....	28
Table 24: Qualitative Objectives and Results – Thermal Comfort.....	30
Table 25: Qualitative Objectives and Results – Ease of Installation.....	31
Table 26: GSA Portfolio by Facility Size.....	31
Table 27: Estimated Heating Energy, Normalized Heating Energy, and Heating Energy Savings.....	34
Table 28: Estimated Cooling Energy, Normalized Cooling Energy, and Cooling Energy Savings.....	35
Table 29: Estimated Fan Energy, Normalized Fan Energy, and Fan Energy Savings.....	36
Table 30: Estimated Total Building Energy.....	37
Table 31: Estimated Normalized Total Building Energy and Savings.....	38
Table 32: Estimated Total Building Energy Cost – Low Utility Rate.....	39
Table 33: Estimated Normalized Total Building Energy Cost – Low Utility Rate.....	40
Table 34: Estimated Total Building Energy Cost – Medium Utility Rate.....	41
Table 35: Estimated Normalized Total Building Energy Cost – Medium Utility Rate.....	42
Table 36: Estimated Total Building Energy Cost – High Utility Rate.....	43
Table 37: Estimated Normalized Total Building Energy Cost – High Utility Rate.....	44
Table 38: Estimated Simple Payback and Savings-to-Investment Ratio.....	45
Table 39: Energy Savings of Single-Pane and Double-Pane Secondary Windows with Low SHGC for Climate Zone 1.....	46
Table 40: Performance Data for Single-Pane and Double-Pane Secondary Window.....	51
Table 41: Single-Pane Window Versus Single-Pane Secondary Window Weight Difference.....	52
Table 42: Double-Pane Window Versus Double-Pane Secondary Window Weight Difference.....	52
Table 43: Summary of EnergyPlus Model for Large Office.....	61
Table 44: Estimated Energy, Normalized Energy Savings, Payback and SIR of Double-pane Secondary Window for Pre-1980 Medium Office.....	66
Table 45: Summary of EnergyPlus Model for Medium Office.....	67

List of Figures

Figure 1: Secondary Window Sample	2
Figure 2: Building 53 - Exterior and Interior	7
Figure 3: Binned outdoor temperature	7
Figure 4: Binned outdoor relative humidity	8
Figure 5: Example of sensor locations on a window	10
Figure 6: Example of measured data	12
Figure 7: Calibrated THERM model for single-pane secondary window	14
Figure 8: Calibrated THERM model for double-pane secondary window	14
Figure 9: Large Office EnergyPlus model representation	15
Figure 10: Baseline predicted monthly electricity use (Denver)	16
Figure 11: Baseline predicted monthly natural gas use (Denver).....	16
Figure 12: Baseline predicted energy use by end use (Denver)	17
Figure 13: PMV and PPD Scale.....	24
Figure 14: Building 53 Supervisor Office – indoor conditions and comfort boundary	25
Figure 15: Building 53 Supervisor Office – PMV and PMV analysis	25
Figure 16: Building 53 Cubicle Office – indoor conditions and comfort boundary	26
Figure 17: Building 53 Cubicle Office – PMV and PMV analysis	26
Figure 18: Convective and radiative heat transfer effects on thermal comfort.....	27
Figure 19: Surface temperatures during cold period	28
Figure 20: Energy use through windows and building envelope.....	29
Figure 21: Impact of infiltration on total electric heating energy	29
Figure 22: IR image (left) of the two windows outside and the visual photo (right) of the same location	58
Figure 23: IR image (left) of the two windows inside and the visual photo (right) of the same location	59
Figure 24: Thermocouples for temperature measurement on glass and frame	59
Figure 25: Surface temperature from the glass to the frame edge.....	60

I. Introduction

A. PROBLEM STATEMENT

A window is an opening in a wall, door, or roof that admits light and air into the building and also enables outside viewing. Windows may also enhance the aesthetic appearance of the building. However, windows typically have significantly inferior thermal properties when compared to walls and roofs, and can impact the energy load for a building. This is the case especially in older buildings with poorly insulated windows (e.g., single-pane windows with metal frames).

B. OPPORTUNITY

High performance, energy-efficient window and glazing systems can significantly reduce energy use in buildings. They have lower heat loss, less air leakage, and warmer window surfaces that improve occupant comfort and minimize condensation. By enabling people to comfortably sit closer to the windows, high performance windows could increase the occupant density. Additionally, they may allow the building to specify smaller, less-costly heating and cooling systems.

This demonstration project assessed the thermal performance, life cycle costs, and deployment potential of two types of window inserts, or “secondary windows,” to be used in conjunction with existing, older windows. The secondary windows utilize fiberglass frames to help reduce thermal conductance through the frames.

C. TECHNOLOGY DESCRIPTION

A secondary window is a separate window unit consisting of a single- or double-pane glazing within its own frame and is typically installed on the room side of existing windows with a seal around the edges and the windowsill. The secondary window can be quickly and easily installed with existing windows to provide a cost-effective and efficient way to improve thermal performance, occupant comfort, and sound reduction—especially for single-pane windows. It uses ultra-thin glass (laminated with safety and performance films) at 1-mm thickness on average and at areas of up to 50 square feet. The secondary window frame is typically a highly insulated framed system, using thermally efficient fiberglass and high R-value polyurethane insulated inserts in the principle chamber in the frame of the product.

The secondary window can be a substantially less expensive alternative to replacing primary windows. In addition, the secondary windows are lightweight and thus suitable for structures that cannot handle additional weight. They are also easily removed to enable window cleaning. Secondary windows significantly improve energy performance over single-pane windows alone. The technology is particularly useful in buildings or areas where planning permission rules do not allow any aesthetic changes whatsoever to the external primary windows (e.g., historic buildings). For this study, two types of secondary windows—single-pane and double-pane—were evaluated. Figure 1 shows a sample of secondary window.



Figure 1: Secondary Window Sample

Credit: Alpen Windows

D. RESEARCH OPPORTUNITY

As shown in Table 1, it is estimated that windows are responsible for 39% of commercial heating energy use and 28% of commercial cooling energy use, or 34% of all commercial space conditioning energy use, equivalent to roughly 1.5% of total U.S. energy consumption (Apte and Arasteh 2006). High insulating windows could significantly reduce the annual U.S. energy use due to windows, but in some cases replacement can be costly; even more so in older buildings where lead paint and/or asbestos must be remediated as part of a window replacement. However, in addition to the energy savings from highly insulating windows, these older buildings may benefit from improved comfort of occupants close to the windows, thereby increasing the occupancy density of the building, and the ability to use smaller, less costly heating and cooling systems when they need to be replaced.

Table 1: U.S. Annual Commercial Building HVAC and Window-Related Energy Use, Reported in Quadrillion BTUs of Primary (Source) Energy

	Building HVAC Energy Consumption	Window-Related Energy Consumption	Percent of Building HVAC Energy Related to Windows	Window-Related Energy Consumption for Triple Glazing Performance	Building HVAC Energy Savings for Triple Glazing
Heating	2.45	0.96	39%	0.25	29%
Cooling	1.90	0.52	28%	0.21	16%
Total	4.35	1.48	34%	0.46	23%

Source: Apte and Arasteh (2006)

The U.S. General Services Administration (GSA) pursues cost-effective energy efficiency opportunities for its more than 9,600 facilities. Thus, a variety of highly insulating fenestration products have been evaluated and recommended in the past. However, GSA facilities still have substantial numbers of poorly performing or underperforming windows and the newest technologies still need to be evaluated. Presently, there are a variety of commercially available retrofit and replacement windows that may provide sufficient thermal insulation and reduce air infiltration. ENERGY STAR™ rated windows have an overall R-value of 3 (R-3). However, even a small increase to R-5 could reduce heat loss through the window by 30%–40%. Unfortunately, many facilities are not able to accommodate the size and/or weight increases associated with these more energy-efficient windows. Furthermore, the added costs of the extra glass and associated assemblies may be cost prohibitive.

II. Evaluation Plan

A. EVALUATION DESIGN

STUDY DESIGN AND OBJECTIVES

As discussed below, several different evaluations assessed the viability of the secondary windows for GSA applications. Some of these assessments were performed with models, while others required onsite evaluations including time series measurements. The primary objectives of the onsite measurement and verification (M&V) study are:

Objective 1. Verify the high performance benefits of the secondary windows:

- a) Thermal performance
- b) Heating, ventilating, and air conditioning (HVAC) energy reduction
- c) Thermal load (cooling and heating) reduction
- d) Comfort improvement

Objective 2. Economic analysis (savings to investment ratio [SIR] and payback)

Objective 3. Evaluate ease of installation and operability

Objective 4. Assess the deployment potential for other GSA sites and identify screening criteria for future candidate buildings and climate zones.

OBJECTIVE 1: VERIFY THE HIGH PERFORMANCE OF SECONDARY WINDOWS

The most important M&V objective is to verify the energy savings. The HVAC energy consumption was evaluated using a simulation modeling approach. Lawrence Berkeley National Laboratory's WINDOW,¹ a computer program, is used for calculating total window thermal performance indices including U-value, solar heat gain coefficient (SHGC), and visible transmittance (VT). WINDOW can be used to analyze window products made with any combination of glazing layers, gas layers, frames, spacers, and dividers under any environmental conditions. It provides a versatile heat transfer analysis method consistent with the rating procedure developed by the National Fenestration Rating Council (NFRC) that is consistent with the International Organization for Standardization (ISO) 15099 standard. In addition, Lawrence Berkeley National Laboratory's THERM² is used with the WINDOW program to model two-dimensional heat transfer of the window including frame and edge effects. Monitoring data were used for calibrating WINDOW and THERM simulation models. Glass surface temperatures predicted by the THERM computer models were compared to measured surface temperatures using the measured environmental conditions as inputs to the model. The thermal performance characteristics of a single-pane window (baseline) and secondary windows were modeled in the EnergyPlus³ simulation modeling tool. EnergyPlus, developed by the U.S. Department of Energy (DOE), is a whole building energy simulation program that is widely used by engineers, architects, and researchers. EnergyPlus requires a detailed description of the building envelope (for thermal and optical properties), internal loads, operating schedules, lighting, HVAC system requirements, and utility rate schedules. The tool is capable of evaluating energy use and energy cost savings that can be achieved by applying energy conservation measures such as improved envelope components, active and passive heating and cooling strategies, lighting system improvements, and HVAC system improvements.

OBJECTIVE 2: ECONOMIC ANALYSIS (PAYBACK)

Cost effectiveness was evaluated based on energy cost savings, retrofit and installation costs, and operation and maintenance costs compared to the incumbent technology. Overall cost effectiveness was compared to the market claim as a part of this demonstration. The success criterion to qualify the product as cost effective was a payback period of less than 15 years and a savings-to-investment ratio (SIR) greater than 1. Savings were comprised of estimated energy cost savings and potential savings from HVAC system sizing reduction. Savings from HVAC system capacity reduction were estimated from the heating and cooling capacity reduction multiplied by cost per unit of HVAC heating and cooling capacity. The unit costs of HVAC heating and cooling capacity were derived from data presented within the U.S. Energy Information Administration's (EIA's) *Updated Buildings Sector Appliance and Equipment Costs and Efficiencies* (EIA 2018). Costs of the technologies used in the analysis came from actual installed costs at the site. For the secondary windows analysis, the first cost of the technology was used.

OBJECTIVE 3: EVALUATE EASE OF INSTALLATION AND OPERABILITY

Ease of installation is an important metric to be evaluated because the secondary windows are installed in retrofit applications. The time and labor required to install the windows is documented in Section III, Demonstration Results. The criterion for success was that it takes less than a day to install and less than an hour

¹ WINDOW, <https://windows.lbl.gov/software/window>

² THERM, <https://windows.lbl.gov/software/therm>

³ EnergyPlus, <https://energyplus.net/>

to commission. Operability was evaluated by interviewing operations and maintenance staff and facility operators on site. The criterion for success was that it should not introduce a steep learning curve to install the windows and should not impact regular operations and maintenance.

OBJECTIVE 4: ASSESS THE DEPLOYMENT POTENTIAL FOR OTHER GSA SITES AND IDENTIFY SCREENING CRITERIA FOR FUTURE CANDIDATE BUILDINGS AND CLIMATE ZONES

One of the main goals of this study was to evaluate suitability of the secondary windows for deployment in GSA buildings across different climate zones. The key metric for determining suitability for deployment was that the simple payback period should be less than 15 years. To evaluate the deployment potential, the DOE Commercial Reference Building Model of a large office was used for the analysis as it represents the majority of the GSA building stock. Analyses were conducted for ten ASHRAE climate zones in which the majority of GSA buildings are located. The energy costs were estimated for three levels of GSA utility rates (low, medium, and high).

Quantitative and qualitative performance objectives for the project are provided in Table 2 and Table 3, respectively.

Table 2: Quantitative Objectives

Quantitative Objectives	Metrics & Data	Success Criteria
Energy Savings	HVAC energy consumption (modeled), kBtu	Energy savings compared to a single-pane window baseline 10% for HVAC energy usage
Thermal Performance Indices	WINDOW (modeled) U-values, Btu/h·ft ² ·°F SHGC, % VT, %	Field installed window within 20% of NFRC-rated values/manufacturers claims
HVAC Peak Loads Reduction	HVAC cooling loads/capacity (modeled), kBtu/hr HVAC heating loads/capacity (modeled), kBtu/hr	HVAC load ^a reduction compared to a single-pane window baseline 10% for HVAC cooling and heating loads
Cost-Effectiveness	Simple payback period, year SIR, unitless	<15-year payback >1 SIR
Thermal Comfort	Space temperature, °F and relative humidity, % Room side glass surface temperature, °F Wall temperature, °F	Space temperature and relative humidity are within range of occupant thermal comfort defined by ASHRAE Standard 55-2013

Quantitative Objectives	Metrics & Data	Success Criteria
Condensation	Room-side glass surface temperature, °F	CR rating greater than 50
	Relative humidity, %	
	Calculated Condensation Resistance (CR) rating, 0–100	

^a HVAC load or capacity for potential HVAC sizing reduction.

Table 2: Qualitative Objectives

Qualitative Objectives	Metrics & Data	Success Criteria
Ease of Installation	Interview with installer	<1 day to install
	Time required to install and configure	
	Labor associated with install	
Thermal Comfort	Tenant satisfaction survey	Improvement in tenant satisfaction with thermal conditions

B. INSTRUMENTATION PLAN

DESCRIPTION OF DEMONSTRATION SITE

GSA selected Building 53 at the Denver Federal Center in Colorado as a demonstration site for testing the secondary windows. The buildings represent a typical GSA office building which constitutes the majority of the GSA building stock. Figure 2 shows the exterior and interior of Building 53 section, where the secondary window testing was conducted.

Building 53 is a 164,000 square-foot, two-story building located on Fifth Street. The building consists largely of office spaces, as well as some light industrial, laboratory, and food service spaces. It also includes small sections of warehouse and conference/training space. The building area where the secondary windows were evaluated is a single-story section that consists of cubicle offices, a supervisor’s closed office, and a conference room. The baseline single-pane window has an original metal frame and dividers. The window is tinted with a fairly dark film. For this study, four double-pane secondary windows were installed at the supervisor’s closed office and four single-pane secondary windows were installed at the cubicle offices. The windows are exposed to the direct sunlight from morning to early afternoon. Each window also has a manually operated interior white woven roller shade. The shades were set in a fully opened position during off hours and weekends. Only periods during which the shades were raised were used for comparing measured data to modeled data.



Figure 2: Building 53 - Exterior and Interior

(Credit: Kosol Kiatreungwattana)

CLIMATE CHARACTERISTICS

Denver is a heating-dominated climate. Figure 3 and Figure 4 show the binned outdoor temperature and the binned outdoor relative humidity from the Typical Meteorological Year (TMY) 3 weather data for Denver International Airport. The outdoor temperature is less than 80°F for more than 80% of the total hours annually.

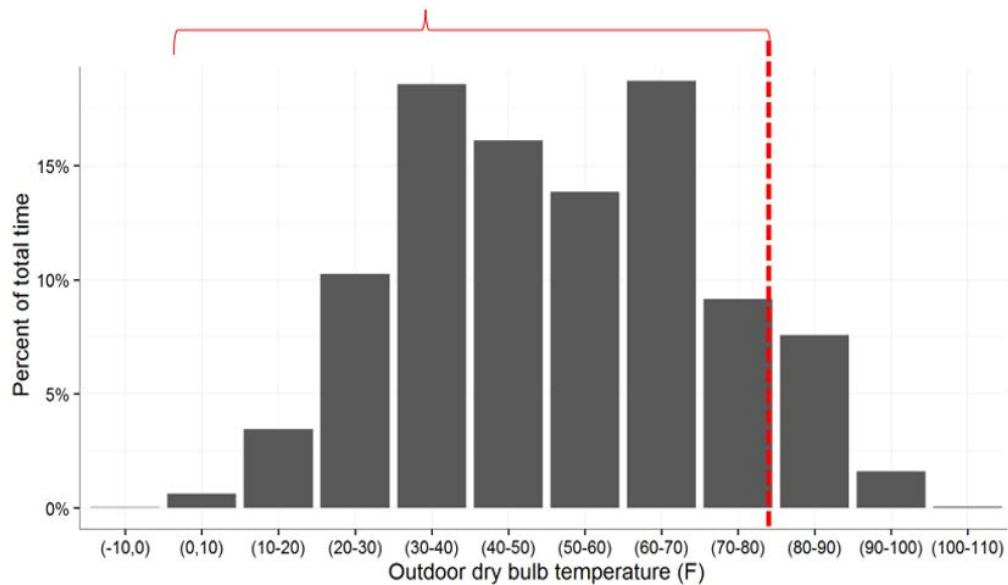

Figure 3: Binned outdoor temperature

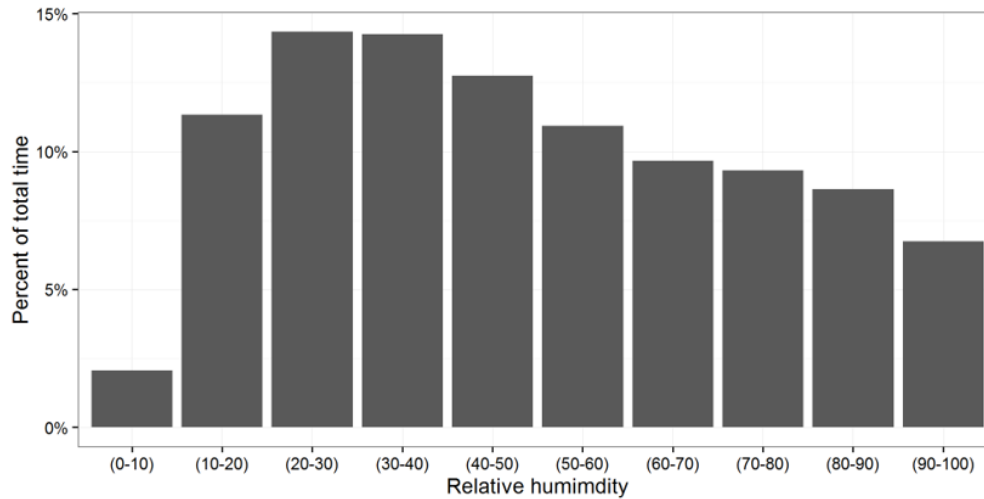

Figure 4: Binned outdoor relative humidity

MONITORING AND INSTRUMENTATION

The National Renewable Energy Laboratory (NREL) team installed a data acquisition system consisting of data loggers, temperature sensors, and wireless temperature and humidity sensors at the baseline single-pane window and secondary windows. Space conditions were monitored for thermal comfort analysis. All monitoring points and instrumentation are described in Table 4. Monitoring data was collected remotely at NREL’s office in Golden, Colorado. Information was sent via a modem connection to the data loggers. Figure 5 shows an example of sensor locations on a window.

Table 4: Monitoring Points and Instrumentation

Monitoring Point	Logging Equipment Description	Location	Notes
Window	Thermocouples	<p>Two glazings (outer and inner)</p> <ol style="list-style-type: none"> Center of glass, inside and outside surfaces (two thermocouples total) Two inches from glass edge, inside and outside surfaces (two thermocouples total) One inch from glass edge, inside and outside surfaces (2 thermocouples total) Frame, inside and outside surfaces (two thermocouples total) Wall between windows 	<p>Up to 50 thermocouples total for Building 53</p> <p>Eight thermocouples per window (note more were used for the existing divided single-pane windows to measure differences between each section of the window)</p>
Space conditions	<p>Temperature sensors</p> <p>Humidity sensors</p>	<p>Work-plane height</p> <p>Room temperature</p> <p>Room relative humidity</p>	<p>Three temperature and humidity sensors for Building 53</p>
Ambient conditions	Weather station	<p>Temperature</p> <p>Humidity</p> <p>Wind speed</p>	<p>Temperature and humidity were measured on-site. Wind speed data from the weather station at NREL Solar Radiation Research Laboratory (SRRL) was used. The NREL SRRL is approximately five miles from the Denver Federal Center.</p>
Comfort	Comfort survey	Employees selected by GSA	Up to six occupant surveys for Building 53
Surface temperature	Thermal imaging camera	Window, frame, and wall	Conduct multiple thermal imaging studies in summer and winter to support window thermal performance indices calculation

The schedule for monitoring and evaluating the technologies is summarized in Table 5.

- Monitoring equipment was installed for the baseline single-pane window in the conference room at Building 53 on September 5–6, 2019. The monitoring data were collected from September 6, 2019 to June 30, 2020.
- Double-pane secondary windows and monitoring equipment were installed on September 4–6, 2019. The monitoring data were collected from September 6, 2019 to June 30, 2020.

- Single-pane secondary windows and monitoring equipment were installed on December 4, 2019. The monitoring data were collected from December 4, 2019 to June 30, 2020.

Table 5: Monitoring and Instrumentation Schedules

Task	Note
Installation of M&V equipment for baseline single-pane windows at Building 53	Baseline M&V equipment was installed for a single-pane window in the conference room on September 5–6, 2019.
Installation of secondary windows at Building 53	Double-pane secondary windows were installed on September 4, 2019.
	Single-pane secondary windows were installed on December 4, 2019.
Installation of M&V equipment for secondary windows at Building 53	M&V equipment for double-pane secondary windows was installed on September 5–6, 2019.
	M&V equipment for single-pane secondary window was installed on December 4, 2019.

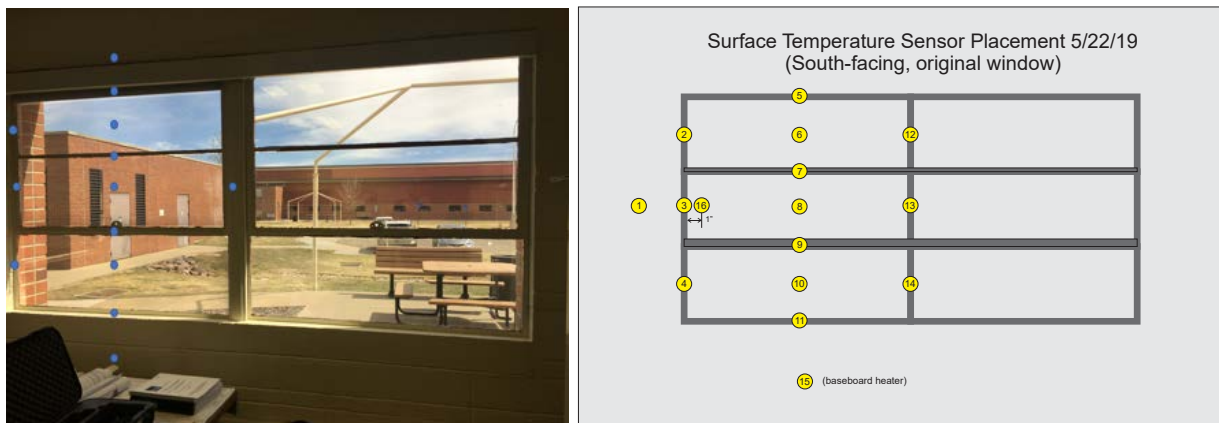

Figure 5: Example of sensor locations on a window

III. Demonstration Results

A. MONITORING ACTIVITIES

Measured temperature responses were taken of the high-performance and secondary window components at Building 53 for comparison to those predicted by the detailed computer models THERM and WINDOW. Driving functions, which were used as inputs to the models, and the responses of certain points in the window systems were measured. It should be noted that we did not attempt to measure the solar-gain-related behavior of the windows—only the conduction and convection behavior was measured. It was assumed that the transmittance and spectral properties of the glazing materials were already well characterized by laboratory tests. We were also not attempting to measure or model the thermal capacity behavior of the window components as the THERM and WINDOW programs assume steady-state conditions. With these parameters in mind, the following measurements were made:

1. Driving functions
 - a. Outdoor dry-bulb temperature
 - b. Indoor dry-bulb temperature approximately 30 cm from the window
2. Responses
 - a. Window frame temperatures, inside and outside
 - b. Glazing temperatures 2.5 cm (1 inch) from the frame, inside and outside
 - c. Glazing temperatures at the center of the glazing, inside and outside.

All temperature measurements were taken using 30-gauge thermocouples affixed to the surfaces using Kapton tape. Temperatures were measured continuously and stored as 1-minute, 15-minute, 60-minute, and daily averages. All data were stored on the data loggers themselves, a personal computer, and on a cloud-based server. Our approach was to search for 15-minute-averaged points within the data that met the following criteria to ensure that the data represented near-steady-state conditions in which the temperatures are nearly constant, and the wind is minimal for a period of time.

1. Time is after sunset and before sunrise to eliminate impacts of direct solar gain to the window
2. Wind speed has been near-zero for 30 minutes, to eliminate the impacts of convection heat transfer to the window
3. Standard deviation of wind speed over the last 30 minutes is at a minimum
4. Standard deviation of outdoor dry-bulb temperature over the last hour is at a minimum
5. Standard deviation of indoor dry-bulb temperature near the window over the last hour is at a minimum
6. Standard deviation of outdoor center-of-glass temperature over the last hour is at a minimum
7. Standard deviation of indoor center-of-glass temperature over the last hour is at a minimum.

Two sets of data that met the steady-state criteria for each of the three windows under study were used for THERM and WINDOW modeling and calibration. Figure 6 shows an example of a data set. Filtered data (black dot) that met the steady-state criteria were used to support THERM and WINDOW modeling.

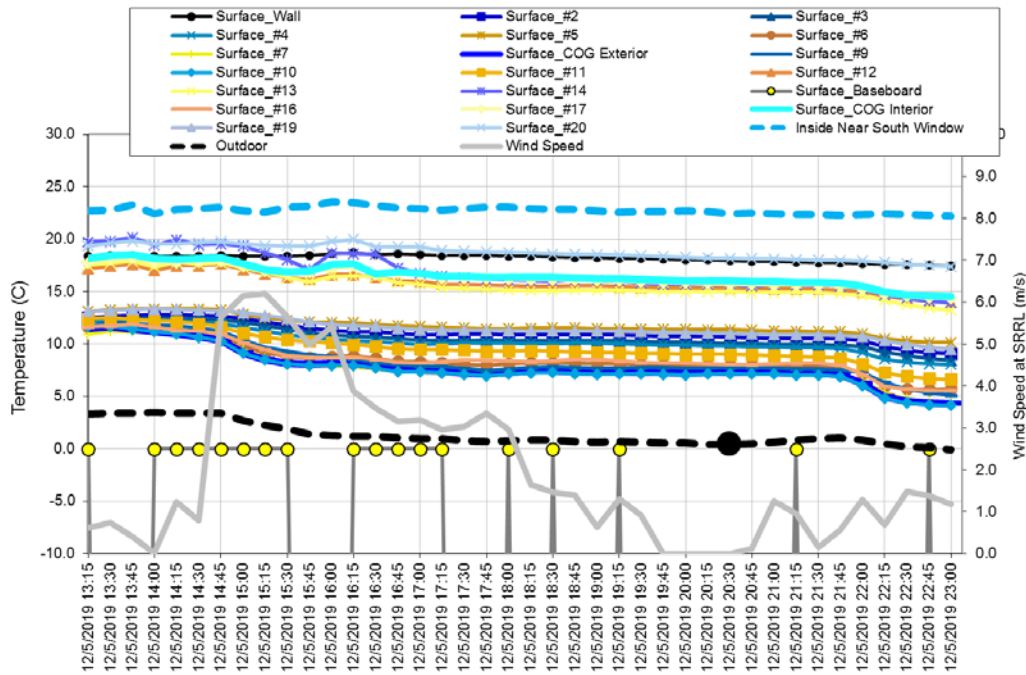

Figure 6: Example of measured data

In addition to the above measurements, several infrared (IR) photos of the temperature gradient near the edge of the glass were taken on a few occasions in the early morning before the sun hit the glass. These photos were analyzed to show a more detailed set of temperatures along the steep gradient than can be inferred from the few point measurements that were made continuously.

MONITORING ISSUES AND FINDINGS

Issues and findings related to monitoring included the following.

1. **Wind speed:** Calculating actual forced-convection heat transfer coefficients based on wind speed is notoriously difficult, but calculating natural convection based on surface and air temperatures under zero wind speed is much more reliable. Wind data was taken from the SRRL. The near-zero wind speed for a period of time was used to assume steady-state conditions. It was assumed that if the wind speed at SRRL was zero, it was likely to be zero at the Denver Federal Center.
2. **Infrared energy exchange:** Radiant temperature with which the window system exchanges heat via IR radiation was not measured. There are two radiant environments, one outdoors and one indoors. The indoor environment can reasonably be assumed to be equal to the indoor dry-bulb temperature, as nearly all the view factor of the inside of the windows is to interior walls. The outdoor environment temperature is not as easily determined. The window has significant view factors to the adjacent buildings, to the ground, and to the sky. Sky temperature is available from SRRL, but the temperatures of the adjacent buildings and ground were unknown. The building and ground temperatures were estimated for boundary conditions in the THERM model.
3. **Window coverings:** All of the windows studied have operable window coverings that the occupants of the offices use regularly to reduce glare in the office space. When the window covering is down, even part-way,

the heat transfer mechanisms affecting the window are changed significantly. Therefore, only data during periods when the window covering was disabled were compared to the THERM and WINDOW models. The building manager ensured the blinds were fully opened at the end of each day and weekend in Building 53.

4. **Baseboard heaters:** At Building 53, there are baseboard heaters actively running underneath all of the windows. This was a concern because it could directly affect the bulk air temperature near the inside of the window, which is a driving function of the models. Temperature sensors were installed for the baseboard heaters to monitor when the heaters are running. The results showed that the baseboard heaters were running almost all of the time during the night. However, the bulk air temperature near the window and this temperature remained steady most of the time, allowing it to meet the steady-state criteria described above.

THERM AND WINDOW MODELING

THERM and WINDOW models were created for the baseline single-pane window and secondary windows. Measured glass and frame surface temperatures were used for calibration and comparison with predicted surface temperatures.

The baseline single-pane window has metal dividers that do not represent a typical single-pane window. Therefore, a model of the baseline window with metal dividers was created for a comparison and calibration with monitoring data, but a model for the baseline window without dividers was used for further analysis in EnergyPlus building energy simulation modeling.

Table 6 presents the WINDOW results of calculated window system performance indices.

THERM and WINDOW models were created for the cases presented below.

1. Baseline single-pane window
 - With metal dividers
 - Without metal dividers
2. Single-pane secondary window
 - Stand-alone (for comparison to claimed thermal performance indices)
 - Integrated with baseline single-pane window with metal dividers for calibration
 - Integrated with baseline single-pane window without dividers for further EnergyPlus analysis
3. Double-pane secondary window
 - Stand-alone (for comparison to claimed thermal performance indices)
 - Integrated with baseline single-pane window with metal dividers for calibration
 - Integrated with baseline single-pane window without dividers for further EnergyPlus analysis.

THERM and WINDOW Model Results and Findings

THERM and WINDOW model results and findings include the following:

- Calibrated THERM models accurately predict measured surface temperatures of the glass and frame of the windows
- The performance indices of single-pane windows with and without metal dividers are similar
 - Results of the single-pane windows without dividers were used as a baseline for other analyses
- U-value of the double-pane secondary window is significantly better than that of the single-pane secondary window

- Double-pane secondary window has approximately half the U-value of the single-pane secondary window.

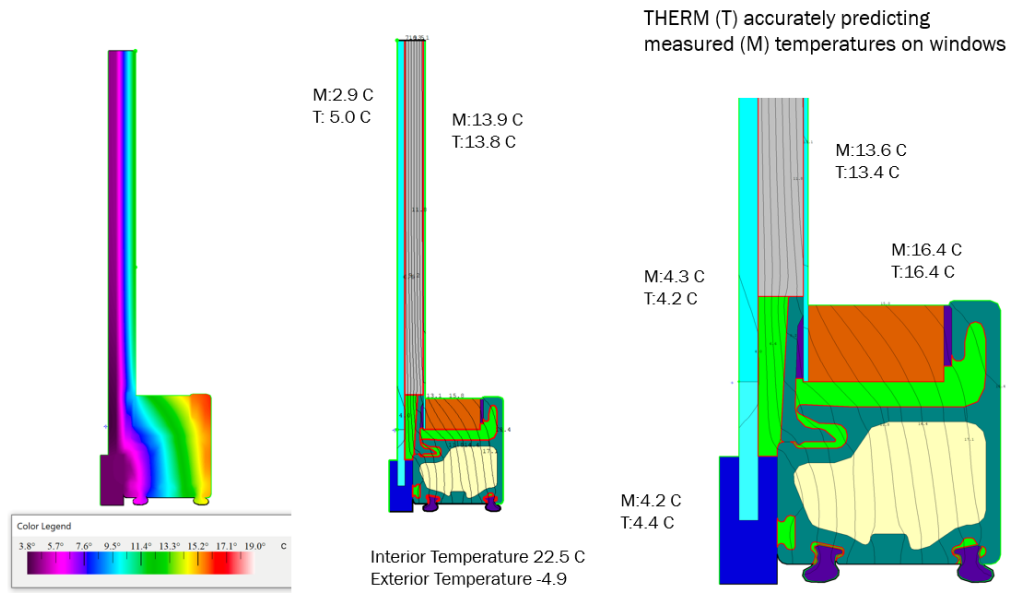

Figure 7: Calibrated THERM model for single-pane secondary window

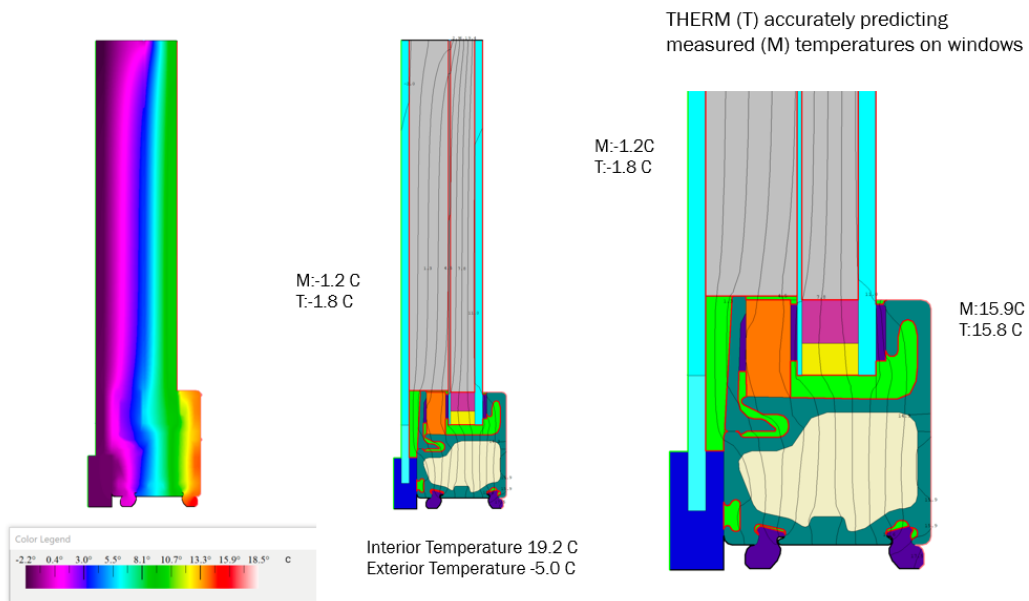

Figure 8: Calibrated THERM model for double-pane secondary window

Table 6: Window Performance Indices Calculated Using WINDOW

	U-Value		Solar Heat Gain Coefficient	Visible Transmittance	Condensation Rating
	(W/m ² ·K)	Btu/(h·ft ² ·F)			
Existing single-pane window	6.799	1.197	0.81	0.84	12
Existing single-pane window with metal dividers	7.475	1.316	0.79	0.82	14
Single-pane secondary window with baselined single-pane window	3.019	0.532	0.70	0.73	44
Double-pane secondary window with baselined single-pane window	1.320	0.232	0.42	0.58	46

ENERGYPLUS MODELING

DOE’s Commercial Reference Building Models for a large-sized office building constructed from 1980–2004, Denver TMY3 weather data, and GSA medium utility rates were used for the whole building simulation analysis to support the evaluation of the technologies at the Denver Federal Center. A graphical representation of the building energy model developed in EnergyPlus is shown in Figure 9. Details and characteristics of the large office building model can be found in Appendix E. Figure 10 and Figure 11 graphically display the predicted monthly electricity and natural gas use. Figure 12 presents the EnergyPlus output for the baseline energy model by end use. As shown, lighting is the largest electrical energy consumer followed by equipment, fan, and cooling.

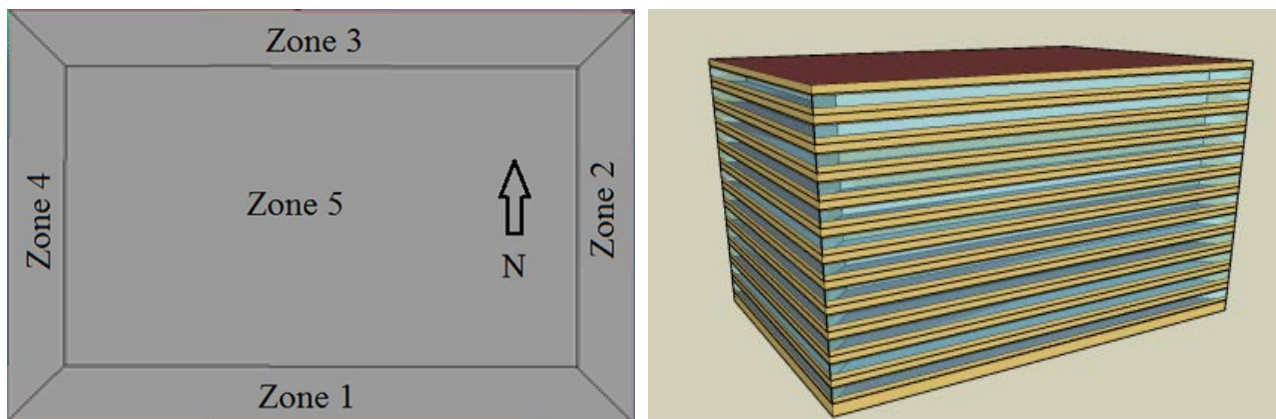

Figure 9: Large Office EnergyPlus model representation

Source: EnergyPlus

Table 7: EnergyPlus Results for Large Office Baseline

Building Metric	Large Office
Total building area	498,588 ft ²
Weather file	Climate Zone 5B, Denver Colorado
Total site energy	37,585,328 kBtu/yr
Site energy use intensity	75.38 kBtu/ft ²
Total energy cost	\$995,932/yr
Normalized energy cost	\$2.00/ft ² /yr

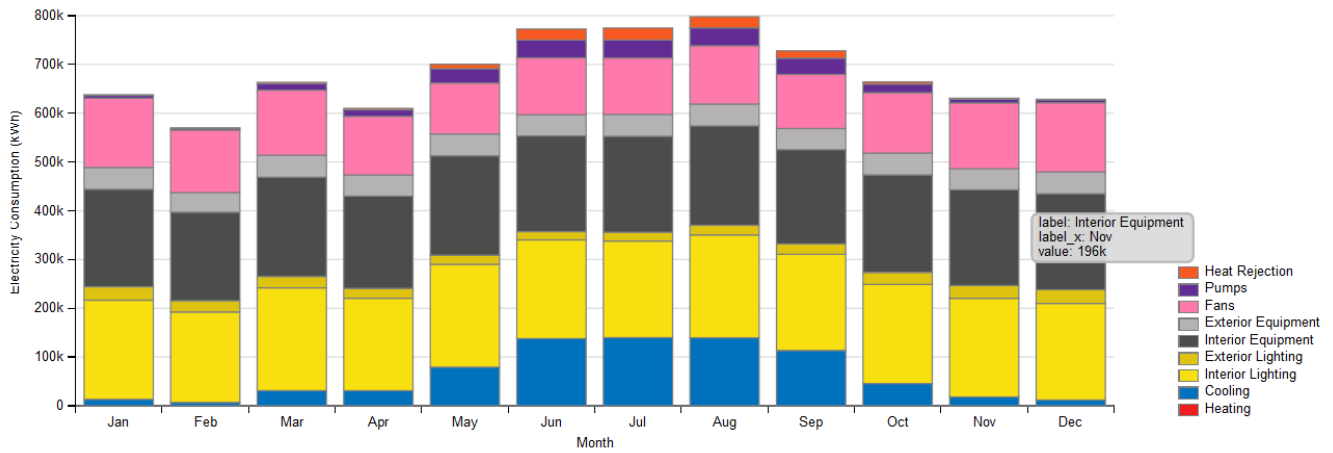

Figure 10: Baseline predicted monthly electricity use (Denver)

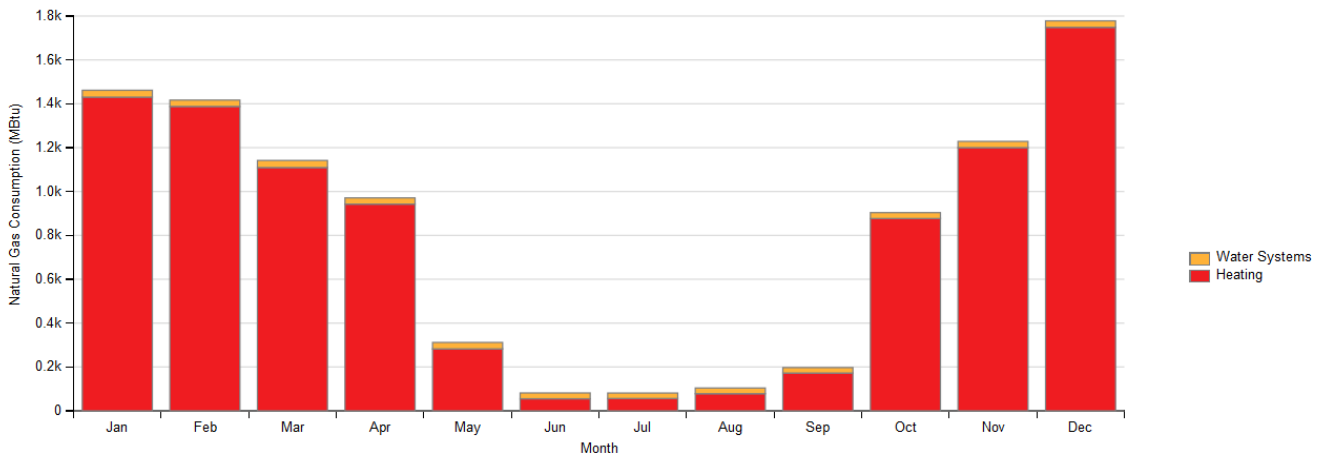

Figure 11: Baseline predicted monthly natural gas use (Denver)

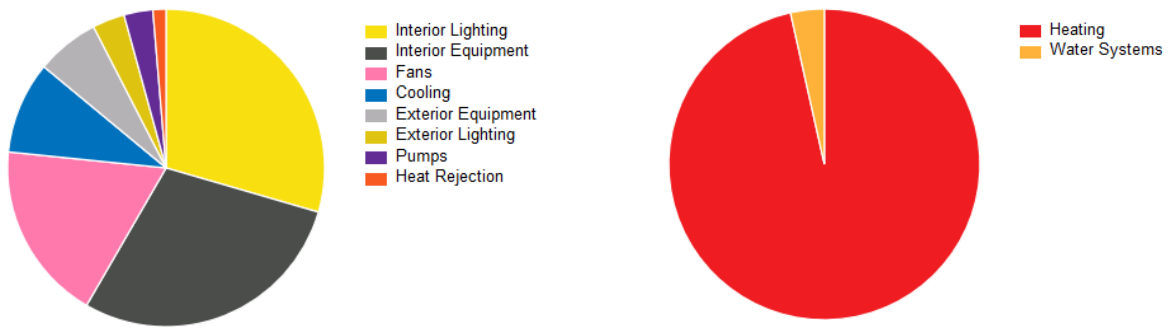

Figure 12: Baseline predicted energy use by end use (Denver)

B. QUANTITATIVE RESULTS

HEATING, VENTILATING, AND AIR CONDITIONING ENERGY SAVINGS

Quantitative results relative to the objectives set out at the start of the evaluation are discussed below. Energy savings were estimated from the EnergyPlus simulation models. The majority of energy savings are from heating and cooling energy reduction. The success criterion was a minimum 10% reduction in heating and cooling energy for the secondary windows.

The success criteria were met. Cooling energy reduction is expected to be 9% to 22%, heating energy reduction is expected to be 28% to 52%, and fan energy reduction is expected to be 12% to 28%. The total HVAC energy reduction is expected to be 20% to 40%. The secondary windows provide greater energy savings due to improved thermal performance. Details of the HVAC energy saving criteria and results can be found in Table 8 and Table 9.

Table 8: Quantitative Objectives and Results – Energy Savings

Quantitative Objectives	Metrics & Data	Success Criteria	Results
Energy Savings	HVAC energy consumption (modeled), kBtu	Energy savings compared to a baseline 10% for HVAC energy usage	HVAC energy savings compared to the baseline Single-pane secondary <ul style="list-style-type: none"> • 20% savings Double-pane secondary <ul style="list-style-type: none"> • 40% savings

Table 9: Estimated Annual HVAC Energy Savings

	Single-Pane Baseline	Single-Pane Secondary	Double-Pane Secondary
Cooling Energy (MBtu)	2,619	2,394	2,052
Heating Energy (MBtu)	9,339	6,706	4,497
Fan Energy (MBtu)	5,091	4,489	3,667
Total HVAC Energy (MBtu)	17,049	13,589	10,216
Reduction in Cooling Energy (%)	N/A	9%	22%
Reduction in Heating Energy (%)	N/A	28%	52%
Reduction in Fan Energy (%)	N/A	12%	28%
Reduction in Total HVAC Energy (%)	N/A	20%	40%

THERMAL PERFORMANCE INDICES

Various thermal performance indices were used as criteria to compare the calculated values from the WINDOW program to manufacturers’ claims. The thermal performance indices of U-value, SHGC, and VT are widely used as ratings values, similar to the gas mileage rating of an automobile or the energy ratings of a refrigerator. The thermal performance indices for the secondary window are for the theoretical case in which the secondary window is used as a stand-alone window, although this type of installation is not recommended by the manufacturer. The secondary windows are specifically designed to be integrated with an existing window. The calculated thermal performance indices of the stand-alone windows were used to compare to the NFRC-rated values. The success criteria were that the calculated values should be within 20% of the manufacturers’ claimed values. However, any performance indices that exceed the 20% range and would indicate greater energy savings are considered to meet the criteria. All performance indices are within the claimed values. The validated U-value of the double-pane secondary window is 30% lower than the claimed value and considered to meet the criteria as it exceeded the thermal performance described above. Details of the thermal performance indices criteria and results are shown in Table 10 and Table 11.

Table 10. Quantitative Objectives and Results – Thermal Performance Indices

Quantitative Objective	Metrics & Data	Success Criteria	Results
Thermal Performance Indices	U-values, Btu/h·ft ² ·F SHGC, % VT, %	Field installed window within 20% of NFRC rated values/manufacturer’s claims	Single-pane secondary <ul style="list-style-type: none"> • U-value 17% lower • SHGC 5% lower • VT 10% greater Double-pane secondary <ul style="list-style-type: none"> • U-value 30% lower • SHGC 16% greater • VT 1% greater

Table 11: Calculated Thermal Performance Indices

	Single-Pane Secondary		Double-Pane Secondary	
	Claimed	Validated	Claimed	Validated
U-value (Btu/(h·ft²·°F))	0.64	0.53	0.33	0.23
SHGC	0.73	0.70	0.36	0.42
VT	81%	73%	58%	58%

HVAC CAPACITY REDUCTION

HVAC capacity reduction was estimated from the EnergyPlus simulation models. This analysis investigated the heating and cooling capacity reduction potential if the HVAC is upgraded at the same time or after the window retrofit as an additional benefit beyond the energy savings from the secondary windows. The success criteria were that the heating and cooling capacity reduction for secondary windows should be at least 10%.

HVAC capacity reduction cost savings were estimated based on the EnergyPlus model and costs per capacity derived from data published by EIA (2018). Cost details can be found in Table 12. HVAC capacity reduction cost savings were estimated and annualized over 20 years as an assumed life expectancy of an HVAC system. The HVAC capacity reduction and savings were estimated to demonstrate that a facility would be able to use smaller, less costly heating and cooling systems when they need to be replaced.

The success criteria are met except for the heating capacity reduction by single-pane secondary windows. In the case of secondary windows, cooling capacity reduction potential is 8% to 13% and heating capacity reduction potential is 10% to 19%. Details of the HVAC capacity reduction criteria and results can be found in Table 13 and Table 14.

Table 12: HVAC Capacity Cost

System Type	System Function	Cost per capacity (\$/kBtu/h)
Gas-fired boiler	Heating	40.56 ^a
Water-cooled chiller	Cooling	40.6 ^b

^a EIA, *Updated Buildings Sector Appliance and Equipment Costs and Efficiencies*, 98 (commercial gas boiler)

^b EIA, *Updated Buildings Sector Appliance and Equipment Costs and Efficiencies*, 102 (average cost per ton, water-cooled centrifugal [400–600 ton])

Table 13: Quantitative Objectives and Results – HVAC Capacity Reduction

Quantitative Objective	Metrics & Data	Success Criteria	Results
HVAC Capacity Reduction	HVAC cooling capacity (modeled), kBtu/hr	HVAC capacity ^a reduction compared to a baseline	Single-pane secondary window <ul style="list-style-type: none"> • 10% for HVAC heating capacity • 8% for HVAC cooling capacity
	HVAC heating capacity (modeled), kBtu/hr	10% for HVAC cooling and heating loads	Double-pane secondary window <ul style="list-style-type: none"> • 19% for HVAC heating capacity • 13% for HVAC cooling capacity

^a HVAC capacity for potential HVAC sizing reduction.

Table 14: Estimated HVAC Capacity Reduction

	Baseline	Single-Pane Secondary	Double-Pane Secondary
Heating Capacity (kBtu/hr)	13,285	12,016	10,774
Cooling Capacity (kBtu/hr)	12,974	11,904	11,258
Reduction in Heating Capacity (%)	n/a	10%	19%
Reduction in Cooling Capacity (%)	n/a	8%	13%
Estimated total HVAC capacity savings (\$)	n/a	94,862	171,515
Annualized HVAC capacity savings (\$/yr)	n/a	4,743	8,576

COST EFFECTIVENESS

Economic evaluations of the window technology were conducted for simple payback⁴ and SIR.⁵ Savings were estimated from energy savings only. Energy cost savings were estimated using the EnergyPlus model with a mid-level GSA utility rate. A window life expectancy of 20 years was assumed for the SIR analysis. The costs of the windows were collected from actual installation costs, which included materials and labor. The costs were then normalized by window area to arrive at costs per area (\$/ft²) that were used to estimate the total costs for analysis of the Large Office Building model. Note that the first cost was used in the analysis of the secondary window cases. More details on analysis and cost assumptions can be found in Table 15. Details of GSA utility rates can be found in Table 16.

⁴ Simple payback refers to the time required to recoup the funds expended in an investment.

⁵ Savings-to-investment ratio is a ratio of the present value savings to the present value costs of an energy conservation measure.

Table 15: Window Costs

Window Type	Window Area (ft ²)	Material Cost (\$)	Labor Cost (\$)	Total Installed Cost (\$)	Cost per Window Area (\$/ft ²), Used in Analysis
Single-pane secondary	98	\$1,666	\$112	\$1,779	\$18.15
Double-pane secondary	65	\$1,430	\$75	\$1,505	\$23.15

Table 16: GSA Utility Rates

Utility Rate*	Electricity (\$/kWh)	Natural Gas (\$/MMBtu)
Low	0.078	5.516
Medium	0.113	7.434
High	0.180	10.506

* Rates were provided by GSA.

Success criteria for the secondary windows were a payback of less than 15 years and a SIR greater than 1.

Most success criteria were met. Simply payback for the secondary windows is between 11 and 18 years and SIR is 1.1–1.9. The economics of the double-pane secondary windows were significantly improved when compared to single-pane secondary windows. The thermal performance improvement of the double-pane secondary windows is significantly greater than that of the single-pane secondary windows while the cost increase is marginal. Details of the cost-effectiveness criteria and results can be found in Table 17 and Table 18.

Table 17: Quantitative Objectives and Results – Cost Effectiveness

Quantitative Objective	Metrics & Data	Success Criteria	Results
Cost-Effectiveness	Simple payback, years SIR, no unit	<15 years payback >1 SIR	<p>Simple payback/SIR</p> <p>Single-pane secondary</p> <ul style="list-style-type: none"> • 18.3 years • 1.1 SIR <p>Double-pane secondary</p> <ul style="list-style-type: none"> • 10.7 years • 1.9 SIR

Table 18: Cost Effectiveness – Simple Payback and Savings-to-Investment Ratio

Performance Metric	Single-Pane Secondary	Double-Pane Secondary
Installed Cost (\$)	905,412	1,154,837
Energy Savings (\$/yr)	12,336	25,011
Simple Payback (yr)	18.3	10.7
SIR	1.1	1.9

CONDENSATION

CR measures how well a window resists the formation of condensation on the inside surface. CR is scored from 1 to 100. The rating value is based on interior surface temperatures at 30%, 50%, and 70% indoor relative humidity for a given outside dry-bulb temperature of 0°F under 15 mph wind conditions. The higher the number, the better a product is able to resist condensation. CR is meant to compare products and their potential for condensation formation. However, CR is an optional rating on the NFRC label. In general, it is recommended to select a window with an NFRC CR rating greater than 50.⁶ For this study, CR was estimated using the WINDOW model at 50% indoor relative humidity, outside dry-bulb temperature of 0°F and 15 mph wind speed.

The success criterion for the CR rating was that it must be greater than 50. The calculated CR for the secondary window integrated with baseline single-pane window is 44–46; therefore, they did not pass the criteria by a narrow margin. The lower CR may not be necessarily caused by the secondary window’s thermal performance, but by the thermal performance of the existing single-pane window. It should also be noted that the CR rating for the existing single-pane window is low at 12–14 due to its inferior thermal performance. Details of the condensation criteria and results can be found in Table 19 and Table 20.

Table 19: Quantitative Objectives and Results – Condensation

Quantitative Objective	Metrics & Data	Success Criteria	Results
Condensation	Room-side glass surface temperature, °F Relative humidity, % CR rating, 0–100	CR rating greater than 50	CR rating Single-pane Secondary with baseline <ul style="list-style-type: none"> • 44 CR Double-pane Secondary with baseline <ul style="list-style-type: none"> • 46 CR CR rating for the existing single-pane window is low at 12–14 due to the fact that it has inferior thermal performance. The secondary windows improved overall condensation rating significantly.

⁶ <http://www.mnshi.umn.edu/kb/scale/condensationresistance.html>

Table 20: Window Performance Ratings Calculated Using the WINDOW Model

	U-value		Solar Heat Gain Coefficient	Visible Transmittance	Condensation Rating
	(W/m ² ·K)	Btu/(h·ft ² ·F)			
Existing single pane window	6.799	1.197	0.81	0.84	12
Existing single pane window with metal dividers	7.475	1.316	0.79	0.82	14
Single-pane secondary window with baseline single-pane window	3.019	0.532	0.70	0.73	44
Double-pane secondary window with baseline single-pane window	1.320	0.232	0.42	0.58	46

THERMAL COMFORT

Thermal comfort is the feeling of satisfaction with the thermal environment and is assessed by subjective evaluation. ASHRAE Standard 55 specifies conditions for acceptable thermal environments and is intended for use in design, operation, and commissioning of buildings and other occupied spaces. Thermal comfort analysis was conducted using the University of California at Berkeley Center for the Built Environment (CBE) Thermal Comfort Tool.⁷ The monitored indoor temperature and humidity ratio during occupied and unoccupied periods for the month of January (representing the winter peak month) and July (representing the summer peak month) were averaged. Other inputs, shown in Table 21, including air velocity, metabolic rate, and clothing level were assumed and used with the indoor temperatures and humidity ratios for those hours in winter and summer. Details and description of inputs can be found on the CBE Thermal Comfort Tool website.

Table 21: Inputs to the CBE Thermal Comfort Tool

	Winter	Summer
Air velocity [fpm]	20	29.5
Metabolic rate [met]	1	1.1
Clothing level [clo]	1	0.5

The CBE Thermal Comfort Tool calculates the predicted mean vote (PMV) and the predicted percentage of dissatisfied (PPD), the most widely used thermal comfort indices (Figure 13).

PMV is an index that aims to predict the mean value of votes of a group of occupants on a seven-point thermal sensation scale. Thermal equilibrium is obtained when an occupant’s internal heat production is the same as its heat loss. The heat balance of an individual can be influenced by levels of physical activity and clothing insulation, as well as the parameters of the thermal environment. For example, thermal sensation is generally perceived as better when occupants of a space have control over indoor temperature (i.e., natural ventilation

⁷ CBE Thermal Comfort Tool, <https://comfort.cbe.berkeley.edu/>

through opening or closing windows), as it helps to alleviate high-occupancy thermal expectations on a mechanical ventilation system. Within the PMV scale, +3 indicates “too hot,” while -3 indicates “too cold.”

Once the PMV is calculated, the PPD, an index that establishes a quantitative prediction of the percentage of thermally dissatisfied occupants (i.e., those who are too warm or too cold), can be determined. PPD essentially gives the percentage of people predicted to experience local discomfort. The main factors causing local discomfort are unwanted cooling or heating of an occupant’s body. Common contributing factors are drafts, abnormally high vertical temperature differences between the ankles and head, and/or floor temperature.⁸

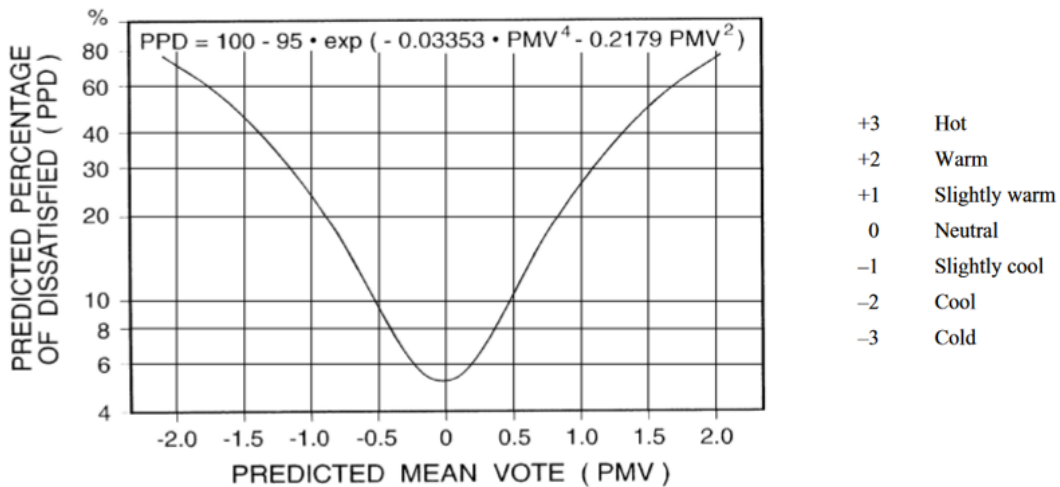

Figure 13: PMV and PPD Scale

Source: ASHRAE Standard 55-2017 Thermal Environmental Conditions for Human Occupancy

Figure 14 and Figure 16 show the plots of monitored indoor conditions from Building 53 during occupied and unoccupied periods in winter and summer within the comfort boundary on a psychrometric chart per ASHRAE Standard 55.

The thermal comfort criteria are met as the results show that the majority of the conditions were within the comfort boundary. Details of the thermal comfort criteria and results can be found in Table 23. The results show that there were a small number of hours (5% to 10%) that were outside the comfort boundary. However, the PMV and PPD analyses, presented in Figure 15 and Figure 17, show that the space in Building 53 was slightly cool and predicts that up to 45% of the occupants could experience some local thermal discomfort.

It should be noted that none of the measured indoor conditions were expected to have been completely affected by the presence of the window systems being evaluated. However, the indoor temperatures and humidity levels are also expected to have been produced by the HVAC system and could have been the same with or without the new windows. Therefore, the thermal comfort analysis results may not present the effects caused by the windows alone, but may also include other factors such as physical activity and clothing insulation, as well as the parameters of the thermal environment by HVAC operation.

⁸ For more information, see “What is PMV and PPD?” <https://www.simscale.com/blog/2019/09/what-is-pmv-ppd/>

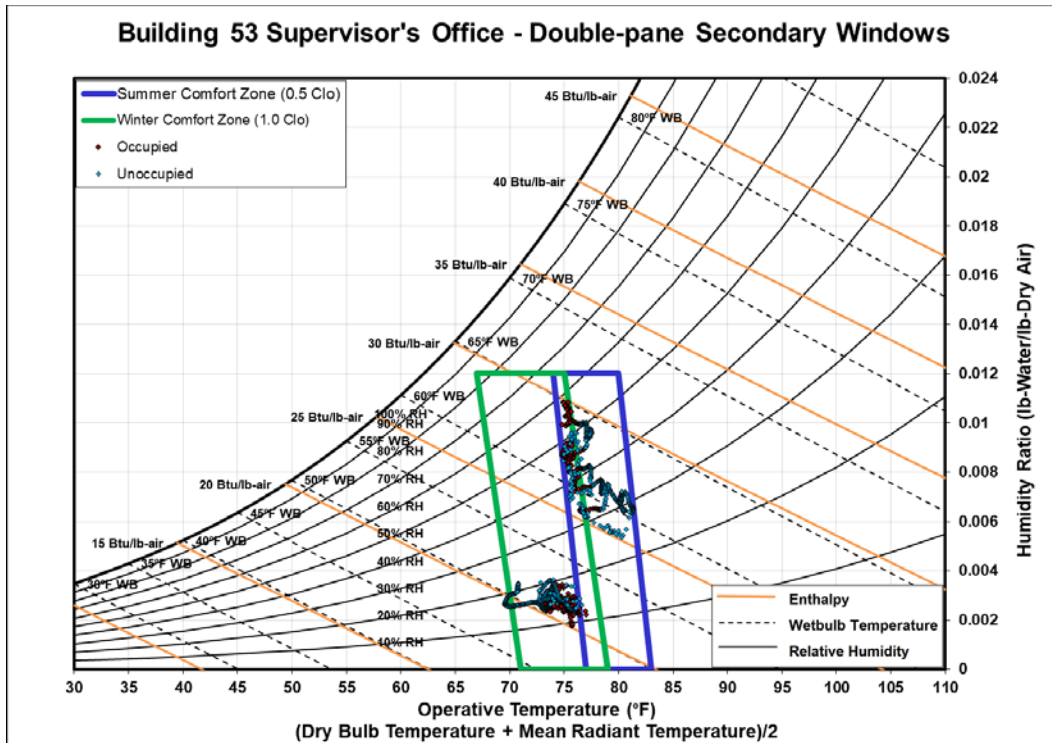

Figure 14: Building 53 Supervisor Office – indoor conditions and comfort boundary

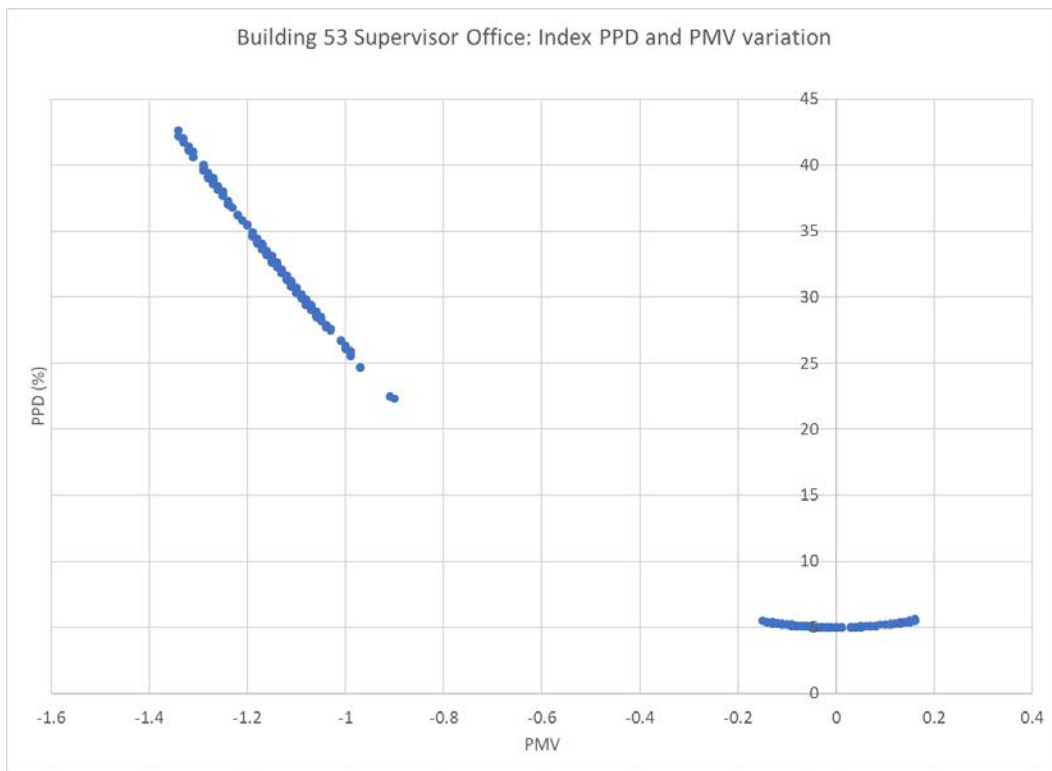

Figure 15: Building 53 Supervisor Office – PMV and PMV analysis

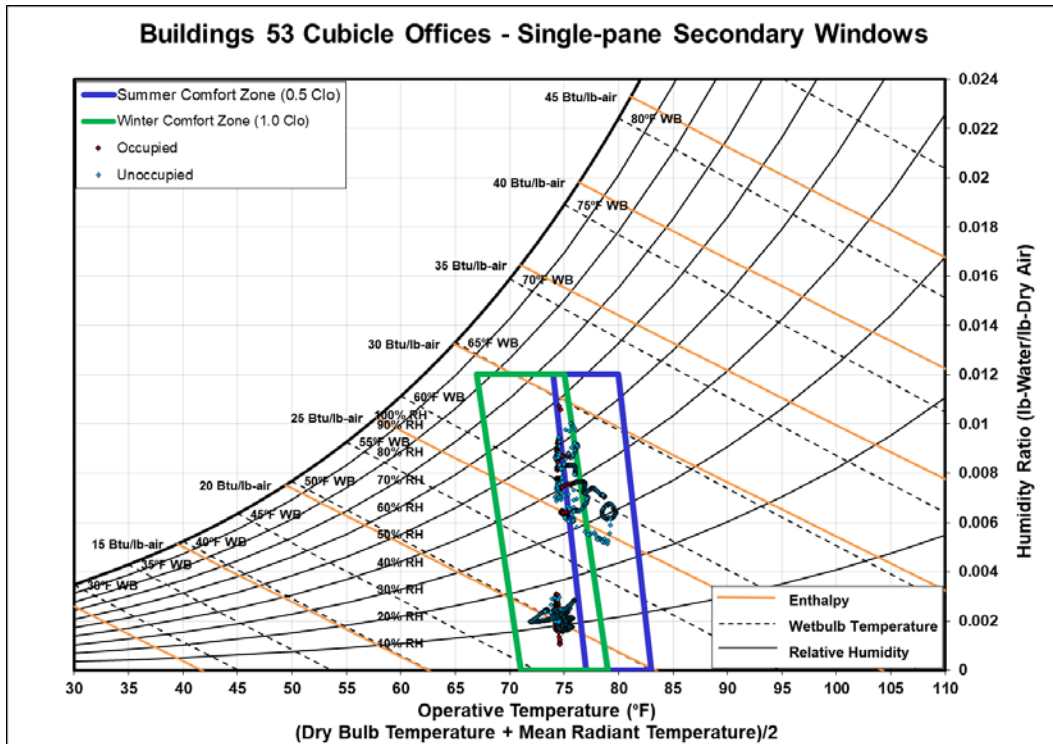

Figure 16: Building 53 Cubicle Office – indoor conditions and comfort boundary

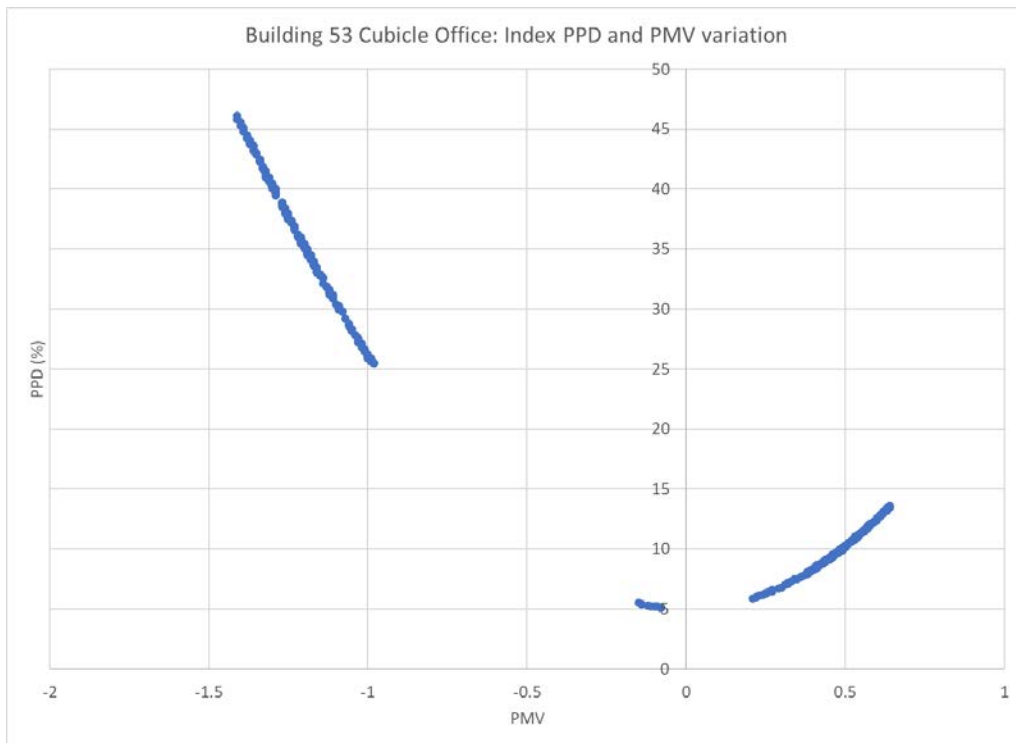

Figure 17: Building 53 Cubicle Office – PMV and PPD analysis

Table 22: Quantitative Objectives and Results – Thermal Comfort

Quantitative Objective	Metrics & Data	Success Criteria	Results
Thermal Comfort	Space temperature, °F and relative humidity, % Room side glass surface temperature, °F Wall temperature, °F	Space temperature and relative humidity are within occupant thermal comfort defined by ASHRAE Standard 55-2013	Secondary window A small number of hours (5% to 10%) fell outside the comfort boundary.

In addition, measured temperatures at the center of the glass during the coldest period (Figure 19) show significant improvement by the secondary window. The average temperatures (Table 23) at the center of the glass of the double-pane secondary window and single-pane secondary window are 68.2°F and 56.7°F, compared baselined single-pane window at 48°F. Large temperature differences increase radiant asymmetry that contributes to occupant discomfort. ASHRAE 55 guidelines state that for vertical surfaces radiant asymmetry should be kept to less than 18°F (Huizenga 1999). The vertical surface radiant asymmetry of the double-pane secondary, single-pane secondary, and baselined single-pane are approximately 5°F, 16°F, and 25°F, respectively. For this circumstance, the vertical surface radiant asymmetry of the double-pane secondary and single-pane secondary windows are within the ASHRAE guidelines.

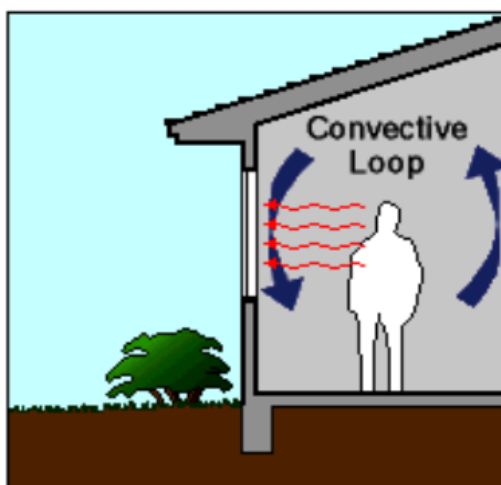

Figure 18: Convective and radiative heat transfer effects on thermal comfort

Source: Huizenga (1999)

Temperature differences between the window surface and indoor air can also induce convective heat transfer through air movement, particularly in cold conditions. Drafts caused by the air movement can also contribute to occupant discomfort. Figure 18 demonstrates convective and radiative heat transfer effects on thermal comfort.

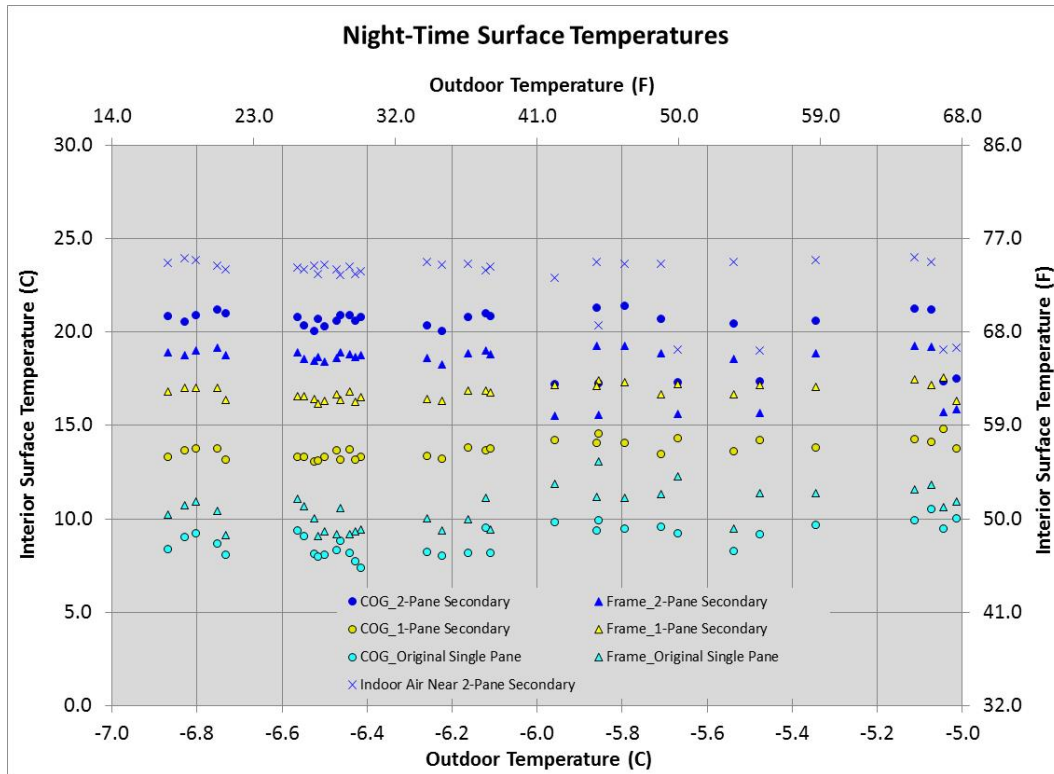

Figure 19: Surface temperatures during cold period

Table 23: Average Surface Temperature During Cold Period

	Center of Glass		Frame	
	°C	°F	°C	°F
Double-Pane Secondary Window	20.1	68.2	18.3	64.8
Single-Pane Secondary Window	13.7	56.7	16.8	62.2
Baselined Single-Pane Window	8.9	48.0	10.5	50.9

Mean Outdoor Temperature: -6.1°C (21.0 °F)
Mean Indoor Temperature: 22.9°C (73.2 °F)

INFILTRATION

DOE (2019a) estimates that air infiltration accounts for approximately 20% of building envelope energy use in commercial buildings (Figure 20). Energy loss due to air infiltration is greater in cold climates (Figure 21), especially for a building with old and leaky single-pane windows (Gowri, Winiarski, and Jarnagin 2009). Many old windows suffer from poor airtightness, resulting in excessive loss of heat to the outside and increasing energy use. This is due to the window deteriorating over time and forming a less effective air seal. Secondary windows could provide the additional benefit of reduced air infiltration, which results in additional energy savings.

Commercial Building Windows and Envelope

6 Quads of energy (DOE 2014)

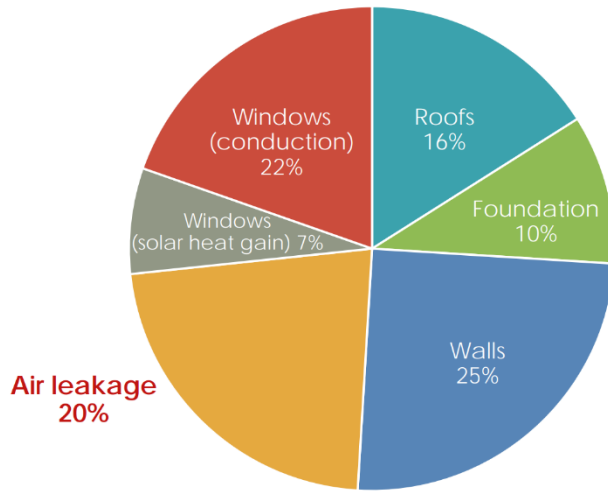

Figure 20: Energy use through windows and building envelope

Source: DOE (2019a)

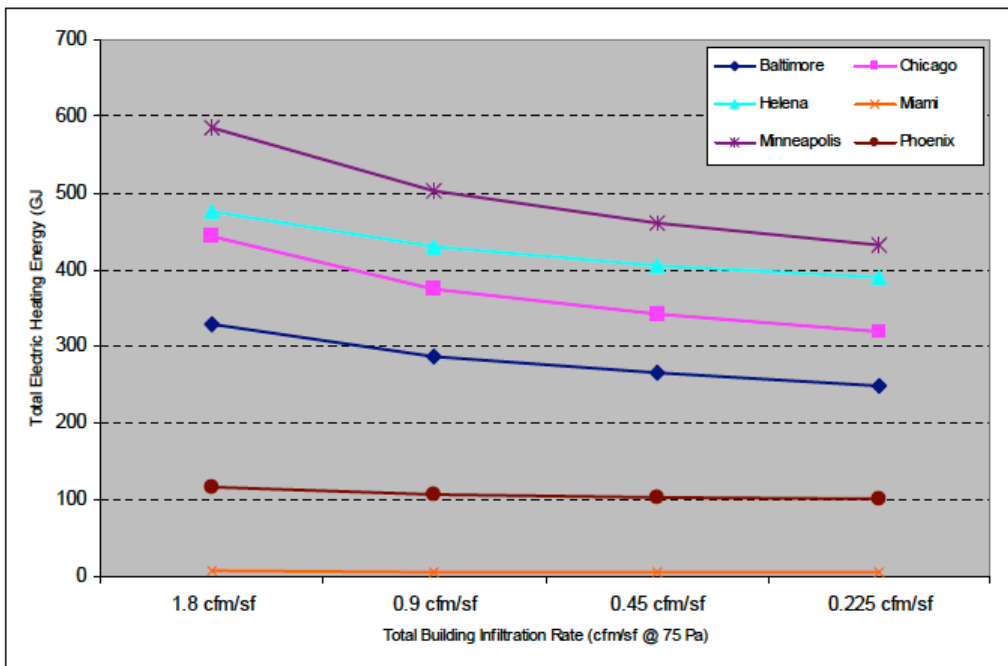

Figure 21: Impact of infiltration on total electric heating energy

Source: DOE (2009)

At the time of M&V project plan development for this study, there was no agreed-upon measurement protocol for infiltration. The Attachments Energy Ratings Council (AERC) is in the process of establishing a standard for secondary windows in commercial buildings that will include air leakage. AERC estimates the average air infiltration for single-pane windows at 2.0 cfm/ft² (AERC 2021). To achieve an ENERGY STAR rating, interior storm windows must have leakage less than 0.5 cfm/ft² (DOE 2019b). From other studies, measured reduction in air leakage around windows using secondary windows varies greatly depending on the initial windows from approximately 7% (Drumheller 2007) to between 60% and 80% for very bad initial single-pane windows (Desjarlais, Childs, and Christian 1998). According to AERC third-party testing (shown in Appendix C), both the single- and double-pane secondary windows could reduce infiltration to 0.06 cfm/ft² for a 97% infiltration reduction that could result in additional energy savings.

C. QUALITATIVE RESULTS

OCCUPANT SURVEYS

In addition to reduced energy consumption, the improved thermal performance of the secondary windows results in warmer room-side glass surface temperatures under cold winter conditions, thereby improving thermal comfort for the occupants and increasing usable office space near windows. A survey was developed and distributed to occupants of the spaces in Building 53 to acquire feedback regarding the thermal comfort of post-installation conditions. Details of the occupant survey form can be found in Appendix D. Details of the qualitative thermal comfort criteria and results can be found in Table 24.

Occupant Survey Results and Findings, Building 53 (Secondary Windows)

- Most survey respondents were positive and recommended the retrofit in the future.
- Thermal discomfort possibly already existed and may be caused by HVAC operation rather than the windows.
- The appearance of the secondary windows was noticeable but acceptable.

Table 34: Qualitative Objectives and Results – Thermal Comfort

Qualitative Objective	Metrics & Data	Success Criteria	Results
Thermal Comfort	Tenant satisfaction survey	Improvement in tenant satisfaction with thermal conditions	<p>Building 53 (secondary windows)</p> <p>Five surveys received; 3/5 were positive and recommended the retrofit. 2/5 did not have opinion on the retrofit.</p> <p>Thermal discomfort existed and may be caused by HVAC rather than windows.</p> <p>Secondary window appearance was noticeable but acceptable.</p>

EASE OF INSTALLATION

This criterion looks at the ease of the installation of the technology. A single secondary window was installed in less than 30 minutes. During the evaluation, the secondary window was uninstalled and reinstalled several times

for installation of thermocouples on the inner surface between the existing window and the secondary window. Details of the qualitative ease of installation criteria and results can be found in Table 25.

Table 25: Qualitative Objectives and Results – Ease of Installation

Qualitative Objective	Metrics & Data	Success Criteria	Results
Ease of Installation	<p>Interview with installer</p> <p>Time required to install and configure</p> <p>Labor associated with install</p>	<1 day to install	<p>Installation of a secondary window, done by one person, took approximately 7-10 minutes to install.</p> <p>The secondary window could be easily installed and uninstalled</p>

DEPLOYABILITY

From a technical standpoint, the secondary window is easily deployed, installed, and operated. The technology is particularly useful in buildings or areas where planning permission rules do not allow any aesthetic changes whatsoever to the external primary windows (e.g., historic buildings).

One of the main goals of this study was to evaluate the suitability for deployment of secondary windows in GSA buildings across different climate zones. The key metrics for determining suitability for deployment are simple payback or SIR. The payback is less than 15 years and the SIR is greater than 1 for both secondary windows. To evaluate the deployment potential, the energy simulation modeling and economic analysis was expanded to ten ASHRAE climate zones—1A to 6A—where the majority of GSA facilities are located. Energy cost savings were estimated for all levels of GSA utility rates (low, medium and high) as shown in Table 16. Table 26 shows that buildings with areas of 50,000 to 500,000 square feet account for 57% of the portfolio.

Table 46: GSA Portfolio by Facility Size

Gross Area (ft ²)		Percent of Inventory
From	To	
1	10,000	9%
10,001	25,000	9%
25,001	50,000	10%
50,001	100,000	17%
100,001	500,000	40%
500,001	1,000,000	10%
1,000,001		5%

Tables 27 to 29 present estimated heating, cooling, and fan energy savings of the single-pane and double-pane secondary windows. Tables 30 to 37 show the estimated total building energy and cost savings of the single- and

double-pane secondary windows at various utility rate levels. The estimated payback and SIR of the single-pane and double-pane secondary windows are presented in Table 38. The results show that the double-pane secondary window is cost effective for most climate zones and at the medium to high utility rate. The economic analysis and estimated savings could be used for future screening for the technology. However, for a future retrofit project, a detailed study including energy modeling analysis of the window options for the specific building is recommended due to the fact that each building is unique. The results and findings are summarized below.

Single-pane Secondary Window

Estimated Heating Energy (1)

- Heating energy reduction between 24% and 38%
- Normalized heating energy savings from 0.4–7.6 kBtu/ft²/yr

Estimated Cooling Energy (2)

- Cooling energy reduction between 6% and 10%
- Normalized cooling energy savings from 0.3–1.0 kBtu/ft²/yr

Estimated Fan Energy (3)

- Fan energy reduction between 8% and 12%
- Normalized fan energy savings from 0.6–1.2 kBtu/ft²/yr

Estimated HVAC Energy (1+2+3)

- HVAC energy reduction between 8% and 20%
- Normalized HVAC energy savings from 1.9–8.8 kBtu/ft²/yr

Estimated Total Building Energy

- Total building energy reduction between 3% and 10%
- Normalized fan energy savings from 2.0–8.9 kBtu/ft²/yr

Estimated Total Building Energy Cost and Economics

- Normalized building energy savings:
 - \$0.04–\$0.08/ft²/yr for low utility rate
 - \$0.06–\$0.12/ft²/yr for medium utility rate
 - \$0.09–\$0.18/ft²/yr for high utility rate
- Payback period:
 - 21.9–44.6 years for low utility rate
 - 15.5–30.9 years for medium utility rate
 - 10.1–19.5 years for high utility rate
- SIR:
 - 0.4–0.9 for low utility rate
 - 0.6–1.3 for medium utility rate

- 1.0–2.0 for high utility rate

Double-pane Secondary Window

Estimated Heating Energy (1)

- Heating energy reduction between 43% and 94%
- Normalized heating energy savings from 1.0–13.6 kBtu/ft²/yr

Estimated Cooling Energy (2)

- Cooling energy reduction between 16% and 26%
- Normalized cooling energy savings from 0.9–2.7 kBtu/ft²/yr

Estimated Fan Energy (3)

- Fan energy reduction between 21% and 28%
- Normalized fan energy savings from 1.6–2.9 kBtu/ft²/yr

Estimated HVAC Energy (1+2+3)

- HVAC energy reduction between 21% and 40%
- Normalized HVAC energy savings from 5.7–17.0 kBtu/ft²/yr

Estimated Total Building Energy

- Total building energy reduction between 8% and 20%
- Normalized fan energy savings from 5.7–17.0 kBtu/ft²/yr

Estimated Total Building Energy Cost and Economics

- Normalized building energy savings:
 - \$0.11–\$0.18/ft²/yr for low utility rate
 - \$0.16–\$0.26/ft²/yr for medium utility rate
 - \$0.26–\$0.41/ft²/yr for high utility rate
- Payback period:
 - 12.5–20.4 years for low utility rate
 - 8.8–14.1 years for medium utility rate
 - 5.7–8.9 years for high utility rate
- SIR:
 - 1.0–1.6 for low utility rate
 - 1.4–2.3 for medium utility rate
 - 2.2–3.5 for high utility rate

Table 27: Estimated Heating Energy, Normalized Heating Energy, and Heating Energy Savings

Climate Zone	Heating Energy (kBtu)			Normalized Heating Energy (kBtu/ft ²)			Heating Energy Savings (%)	
	Single-Pane Baseline	Single-Pane Secondary	Double-Pane Secondary	Single-Pane Baseline	Single-Pane Secondary	Double-Pane Secondary	Single-Pane Secondary	Double-Pane Secondary
1A Miami, Florida	530,996	330,845	33,458	1.06	0.66	0.07	37.7%	93.7%
2A Houston, Texas	1,619,393	1,031,045	503,575	3.25	2.07	1.01	36.3%	68.9%
2B Phoenix, Arizona	2,055,815	1,351,587	740,188	4.12	2.71	1.48	34.3%	64.0%
3A Atlanta, Georgia	4,896,272	3,467,485	2,328,825	9.82	6.95	4.67	29.2%	52.4%
3B Las Vegas, Nevada	3,303,673	2,133,205	1,254,995	6.63	4.28	2.52	35.4%	62.0%
3C San Francisco, California	2,390,025	1,528,602	652,146	4.79	3.07	1.31	36.0%	72.7%
4A Baltimore, Maryland	8,599,829	6,149,618	4,154,074	17.25	12.33	8.33	28.5%	51.7%
5A Chicago, Illinois	11,878,594	8,737,120	6,063,139	23.82	17.52	12.16	26.4%	49.0%
5B Boulder, Colorado	9,339,174	6,706,773	4,497,108	18.73	13.45	9.02	28.2%	51.8%
6A Minneapolis, Minnesota	15,786,918	11,999,791	9,025,797	31.66	24.07	18.10	24.0%	42.8%

Table 28: Estimated Cooling Energy, Normalized Cooling Energy, and Cooling Energy Savings

Climate Zone	Cooling Energy (kBtu)			Normalized Cooling Energy (kBtu/ft ²)			Cooling Energy Savings (%)	
	Single-Pane Baseline	Single-Pane Secondary	Double-Pane Secondary	Single-Pane Baseline	Single-Pane Secondary	Double-Pane Secondary	Single-Pane Secondary	Double-Pane Secondary
1A Miami, Florida	8,208,580	7,750,575	6,915,729	16.46	15.55	13.87	5.6%	15.7%
2A Houston, Texas	8,483,399	7,961,503	7,132,428	17.01	15.97	14.31	6.2%	15.9%
2B Phoenix, Arizona	5,950,244	5,467,673	4,726,461	11.93	10.97	9.48	8.1%	20.6%
3A Atlanta, Georgia	6,140,594	5,652,288	4,879,590	12.32	11.34	9.79	8.0%	20.5%
3B Las Vegas, Nevada	4,616,571	4,246,884	3,650,072	9.26	8.52	7.32	8.0%	20.9%
3C San Francisco, California	4,356,888	4,005,759	3,417,819	8.74	8.03	6.85	8.1%	21.6%
4A Baltimore, Maryland	5,201,563	4,670,179	3,869,662	10.43	9.37	7.76	10.2%	25.6%
5A Chicago, Illinois	2,404,593	2,241,986	1,934,040	4.82	4.50	3.88	6.8%	19.6%
5B Boulder, Colorado	2,619,994	2,393,959	2,052,763	5.25	4.80	4.12	8.6%	21.7%
6A Minneapolis, Minnesota	2,494,607	2,333,914	2,026,310	5.00	4.68	4.06	6.4%	18.8%

Table 29: Estimated Fan Energy, Normalized Fan Energy, and Fan Energy Savings

Climate Zone	Fan Energy (kBtu)			Normalized Fan Energy (kBtu/ft ²)			Fan Energy Savings (%)	
	Single-Pane Baseline	Single-Pane Secondary	Double-Pane Secondary	Single-Pane Baseline	Single-Pane Secondary	Double-Pane Secondary	Single-Pane Secondary	Double-Pane Secondary
1A Miami, Florida	3,833,143	3,533,775	3,010,722	7.69	7.09	6.04	7.8%	21.5%
2A Houston, Texas	3,862,383	3,513,188	2,971,738	7.75	7.05	5.96	9.0%	23.1%
2B Phoenix, Arizona	4,648,398	4,183,361	3,502,270	9.32	8.39	7.02	10.0%	24.7%
3A Atlanta, Georgia	3,925,356	3,534,524	2,957,313	7.87	7.09	5.93	10.0%	24.7%
3B Las Vegas, Nevada	4,634,864	4,114,057	3,390,351	9.30	8.25	6.80	11.2%	26.9%
3C San Francisco, California	3,522,847	3,192,409	2,639,547	7.07	6.40	5.29	9.4%	25.1%
4A Baltimore, Maryland	3,890,827	3,455,684	2,861,005	7.80	6.93	5.74	11.2%	26.5%
5A Chicago, Illinois	4,014,081	3,600,634	2,923,466	8.05	7.22	5.86	10.3%	27.2%
5B Boulder, Colorado	5,091,503	4,489,279	3,666,849	10.21	9.00	7.35	11.8%	28.0%
6A Minneapolis, Minnesota	4,368,811	3,935,242	3,292,811	8.76	7.89	6.60	9.9%	24.6%

Table 30: Estimated Total Building Energy

Climate Zone	Total Building Energy (kBtu)								
	Single-Pane Baseline			Single-Pane Secondary			Double-Pane Secondary		
	Electricity (kBtu)	Natural Gas (kBtu)	Total (kBtu)	Electricity (kBtu)	Natural Gas (kBtu)	Total (kBtu)	Electricity (kBtu)	Natural Gas (kBtu)	Total (kBtu)
1A Miami, Florida	34,189,147	760,453	34,949,600	33,348,917	560,321	33,909,238	31,829,083	262,924	32,092,007
2A Houston, Texas	34,651,549	1,871,200	36,522,749	33,629,006	1,282,852	34,911,858	32,044,379	755,382	32,799,761
2B Phoenix, Arizona	32,213,167	2,309,082	34,522,249	31,134,371	1,604,853	32,739,224	29,503,955	993,464	30,497,419
3A Atlanta, Georgia	31,918,443	5,186,256	37,104,699	30,855,893	3,757,450	34,613,343	29,224,889	2,618,800	31,843,689
3B Las Vegas, Nevada	30,357,995	3,584,000	33,941,995	29,357,725	2,413,531	31,771,256	27,861,814	1,535,331	29,397,145
3C San Francisco, California	28,955,405	2,684,446	31,639,851	28,153,751	1,823,022	29,976,773	26,823,376	946,575	27,769,951
4A Baltimore, Maryland	30,781,091	8,919,897	39,700,988	29,565,496	6,469,667	36,035,163	27,818,878	4,474,123	32,293,001
5A Chicago, Illinois	26,619,899	12,224,149	38,844,048	25,984,596	9,082,647	35,067,243	24,886,142	6,408,656	31,294,798
5B Boulder, Colorado	27,907,726	9,677,592	37,585,318	27,001,973	7,045,182	34,047,155	25,737,614	4,835,526	30,573,140
6A Minneapolis, Minnesota	27,128,839	16,151,287	43,280,126	26,475,821	12,364,151	38,839,972	25,405,527	9,390,157	34,795,684

Table 31: Estimated Normalized Total Building Energy and Savings

Climate Zone	Normalized Building Energy (kBtu/ft ²)										
	Single-Pane Baseline			Single-Pane Secondary				Double-Pane Secondary			
	Electricity (kBtu/ft ²)	Natural Gas (kBtu/ft ²)	Total (kBtu/ft ²)	Electricity (kBtu/ft ²)	Natural Gas (kBtu/ft ²)	Total (kBtu/ft ²)	Savings (kBtu/ft ²)	Electricity (kBtu/ft ²)	Natural Gas (kBtu/ft ²)	Total (kBtu/ft ²)	Savings (kBtu/ft ²)
1A Miami, Florida	68.57	1.53	70.10	66.89	1.12	68.01	2.09	63.84	0.53	64.37	5.73
2A Houston, Texas	69.50	3.75	73.25	67.45	2.57	70.02	3.23	64.27	1.52	65.79	7.47
2B Phoenix, Arizona	64.61	4.63	69.24	62.45	3.22	65.66	3.58	59.18	1.99	61.17	8.07
3A Atlanta, Georgia	64.02	10.40	74.42	61.89	7.54	69.42	5.00	58.62	5.25	63.87	10.55
3B Las Vegas, Nevada	60.89	7.19	68.08	58.88	4.84	63.72	4.35	55.88	3.08	58.96	9.12
3C San Francisco, California	58.07	5.38	63.46	56.47	3.66	60.12	3.34	53.80	1.90	55.70	7.76
4A Baltimore, Maryland	61.74	17.89	79.63	59.30	12.98	72.27	7.35	55.80	8.97	64.77	14.86
5A Chicago, Illinois	53.39	24.52	77.91	52.12	18.22	70.33	7.58	49.91	12.85	62.77	15.14
5B Boulder, Colorado	55.97	19.41	75.38	54.16	14.13	68.29	7.10	51.62	9.70	61.32	14.06
6A Minneapolis, Minnesota	54.41	32.39	86.81	53.10	24.80	77.90	8.91	50.95	18.83	69.79	17.02

Table 32: Estimated Total Building Energy Cost – Low Utility Rate

Climate Zone	Total Building Energy Cost (\$) - Low Utility Rate										
	Single-Pane Baseline			Single-Pane Secondary				Double-Pane Secondary			
	Electricity (\$)	Natural Gas (\$)	Total (\$)	Electricity (\$)	Natural Gas (\$)	Total (\$)	Savings (\$)	Electricity (\$)	Natural Gas (\$)	Total (\$)	Savings (\$)
1A Miami, Florida	781,352	4,195	785,546	762,149	3,091	765,240	20,306	727,415	1,450	728,866	56,681
2A Houston, Texas	791,919	10,322	802,241	768,550	7,076	775,627	26,614	732,336	4,167	736,502	65,739
2B Phoenix, Arizona	736,193	12,737	748,930	711,539	8,852	720,391	28,539	674,277	5,480	679,757	69,173
3A Atlanta, Georgia	729,458	28,607	758,065	705,174	20,726	725,900	32,165	667,900	14,445	682,345	75,720
3B Las Vegas, Nevada	693,795	19,769	713,565	670,935	13,313	684,248	29,316	636,748	8,469	645,217	68,348
3C San Francisco, California	661,741	14,807	676,548	643,420	10,056	653,476	23,072	613,016	5,221	618,237	58,311
4A Baltimore, Maryland	703,465	49,202	752,667	675,684	35,687	711,370	41,296	635,767	24,679	660,446	92,221
5A Chicago, Illinois	608,366	67,428	675,794	593,847	50,100	643,946	31,848	568,743	35,350	604,093	71,701
5B Boulder, Colorado	637,797	53,382	691,179	617,098	38,861	655,959	35,220	588,202	26,673	614,875	76,304
6A Minneapolis, Minnesota	619,997	89,090	709,087	605,073	68,201	673,274	35,814	580,613	51,796	632,409	76,679

Table 33: Estimated Normalized Total Building Energy Cost – Low Utility Rate

Climate Zone	Normalized Total Building Energy Cost (\$) - Low Utility Rate										
	Single-Pane Baseline			Single-Pane Secondary				Double-Pane Secondary			
	Electricity (\$/ft ²)	Natural Gas (\$/ft ²)	Total (\$/ft ²)	Electricity (\$/ft ²)	Natural Gas (\$/ft ²)	Total (\$/ft ²)	Savings (\$/ft ²)	Electricity (\$/ft ²)	Natural Gas (\$/ft ²)	Total (\$/ft ²)	Savings (\$/ft ²)
1A Miami, Florida	1.57	0.01	1.58	1.53	0.01	1.53	0.04	1.46	0.00	1.46	0.11
2A Houston, Texas	1.59	0.02	1.61	1.54	0.01	1.56	0.05	1.47	0.01	1.48	0.13
2B Phoenix, Arizona	1.48	0.03	1.50	1.43	0.02	1.44	0.06	1.35	0.01	1.36	0.14
3A Atlanta, Georgia	1.46	0.06	1.52	1.41	0.04	1.46	0.06	1.34	0.03	1.37	0.15
3B Las Vegas, Nevada	1.39	0.04	1.43	1.35	0.03	1.37	0.06	1.28	0.02	1.29	0.14
3C San Francisco, California	1.33	0.03	1.36	1.29	0.02	1.31	0.05	1.23	0.01	1.24	0.12
4A Baltimore, Maryland	1.41	0.10	1.51	1.36	0.07	1.43	0.08	1.28	0.05	1.32	0.18
5A Chicago, Illinois	1.22	0.14	1.36	1.19	0.10	1.29	0.06	1.14	0.07	1.21	0.14
5B Boulder, Colorado	1.28	0.11	1.39	1.24	0.08	1.32	0.07	1.18	0.05	1.23	0.15
6A Minneapolis, Minnesota	1.24	0.18	1.42	1.21	0.14	1.35	0.07	1.16	0.10	1.27	0.15

Table 34: Estimated Total Building Energy Cost – Medium Utility Rate

Climate Zone	Total Building Energy Cost (\$) - Medium Utility Rate										
	Single-Pane Baseline			Single-Pane Secondary				Double-Pane Secondary			
	Electricity (\$)	Natural Gas (\$)	Total (\$)	Electricity (\$)	Natural Gas (\$)	Total (\$)	Savings (\$)	Electricity (\$)	Natural Gas (\$)	Total (\$)	Savings (\$)
1A Miami, Florida	1,131,958	5,653	1,137,611	1,104,139	4,165	1,108,305	29,307	1,053,820	1,955	1,055,774	81,837
2A Houston, Texas	1,147,268	13,911	1,161,178	1,113,413	9,537	1,122,949	38,229	1,060,948	5,616	1,066,563	94,615
2B Phoenix, Arizona	1,066,536	17,166	1,083,702	1,030,819	11,930	1,042,749	40,953	976,838	7,385	984,223	99,479
3A Atlanta, Georgia	1,056,778	38,555	1,095,333	1,021,599	27,933	1,049,531	45,801	967,598	19,468	987,066	108,267
3B Las Vegas, Nevada	1,005,114	26,643	1,031,757	971,996	17,942	989,938	41,819	922,468	11,414	933,882	97,875
3C San Francisco, California	958,676	19,956	978,632	932,134	13,552	945,686	32,946	888,087	7,037	895,124	83,508
4A Baltimore, Maryland	1,019,122	66,311	1,085,432	978,875	48,096	1,026,971	58,462	921,047	33,261	954,308	131,125
5A Chicago, Illinois	881,350	90,874	972,225	860,316	67,520	927,837	44,388	823,948	47,642	871,590	100,635
5B Boulder, Colorado	923,989	71,943	995,932	894,000	52,374	946,374	49,558	852,139	35,947	888,086	107,846
6A Minneapolis, Minnesota	898,201	120,069	1,018,269	876,580	91,915	968,495	49,774	841,144	69,806	910,950	107,319

Table 35: Estimated Normalized Total Building Energy Cost – Medium Utility Rate

Climate Zone	Normalized Total Building Energy Cost (\$) - Medium Utility Rate										
	Single-Pane Baseline			Single-Pane Secondary				Double-Pane Secondary			
	Electricity (\$/ft ²)	Natural Gas (\$/ft ²)	Total (\$/ft ²)	Electricity (\$/ft ²)	Natural Gas (\$/ft ²)	Total (\$/ft ²)	Savings (\$/ft ²)	Electricity (\$/ft ²)	Natural Gas (\$/ft ²)	Total (\$/ft ²)	Savings (\$/ft ²)
1A Miami, Florida	2.27	0.01	2.28	2.21	0.01	2.22	0.06	2.11	0.00	2.12	0.16
2A Houston, Texas	2.30	0.03	2.33	2.23	0.02	2.25	0.08	2.13	0.01	2.14	0.19
2B Phoenix, Arizona	2.14	0.03	2.17	2.07	0.02	2.09	0.08	1.96	0.01	1.97	0.20
3A Atlanta, Georgia	2.12	0.08	2.20	2.05	0.06	2.11	0.09	1.94	0.04	1.98	0.22
3B Las Vegas, Nevada	2.02	0.05	2.07	1.95	0.04	1.99	0.08	1.85	0.02	1.87	0.20
3C San Francisco, California	1.92	0.04	1.96	1.87	0.03	1.90	0.07	1.78	0.01	1.80	0.17
4A Baltimore, Maryland	2.04	0.13	2.18	1.96	0.10	2.06	0.12	1.85	0.07	1.91	0.26
5A Chicago, Illinois	1.77	0.18	1.95	1.73	0.14	1.86	0.09	1.65	0.10	1.75	0.20
5B Boulder, Colorado	1.85	0.14	2.00	1.79	0.11	1.90	0.10	1.71	0.07	1.78	0.22
6A Minneapolis, Minnesota	1.80	0.24	2.04	1.76	0.18	1.94	0.10	1.69	0.14	1.83	0.22

Table 36: Estimated Total Building Energy Cost – High Utility Rate

Climate Zone	Total Building Energy Cost (\$) - High Utility Rate										
	Single-Pane Baseline			Single-Pane Secondary				Double-Pane Secondary			
	Electricity (\$)	Natural Gas (\$)	Total (\$)	Electricity (\$)	Natural Gas (\$)	Total (\$)	Savings (\$)	Electricity (\$)	Natural Gas (\$)	Total (\$)	Savings (\$)
1A Miami, Florida	1,803,119	7,989	1,811,109	1,758,806	5,887	1,764,693	46,416	1,678,651	2,762	1,681,413	129,696
2A Houston, Texas	1,827,506	19,659	1,847,165	1,773,578	13,478	1,787,055	60,110	1,690,005	7,936	1,697,941	149,224
2B Phoenix, Arizona	1,698,907	24,259	1,723,166	1,642,012	16,861	1,658,873	64,294	1,556,025	10,437	1,566,462	156,704
3A Atlanta, Georgia	1,683,364	54,487	1,737,850	1,627,325	39,476	1,666,801	71,049	1,541,307	27,513	1,568,820	169,030
3B Las Vegas, Nevada	1,601,066	37,654	1,638,720	1,548,312	25,357	1,573,669	65,051	1,469,419	16,130	1,485,549	153,171
3C San Francisco, California	1,527,094	28,203	1,555,297	1,484,815	19,153	1,503,968	51,329	1,414,652	9,945	1,424,597	130,700
4A Baltimore, Maryland	1,623,380	93,712	1,717,093	1,559,270	67,970	1,627,241	89,852	1,467,154	47,005	1,514,160	202,933
5A Chicago, Illinois	1,403,921	128,427	1,532,348	1,370,415	95,422	1,465,838	66,510	1,312,483	67,329	1,379,813	152,535
5B Boulder, Colorado	1,471,840	101,673	1,573,513	1,424,071	74,017	1,498,088	75,425	1,357,390	50,802	1,408,192	165,321
6A Minneapolis, Minnesota	1,430,762	169,685	1,600,448	1,396,322	129,898	1,526,220	74,228	1,339,875	98,653	1,438,528	161,919

Table 37: Estimated Normalized Total Building Energy Cost – High Utility Rate

Climate Zone	Normalized Total Building Energy Cost (\$) – High Utility Rate										
	Single-Pane Baseline			Single-Pane Secondary				Double-Pane Secondary			
	Electricity (\$/ft ²)	Natural Gas (\$/ft ²)	Total (\$/ft ²)	Electricity (\$/ft ²)	Natural Gas (\$/ft ²)	Total (\$/ft ²)	Savings (\$/ft ²)	Electricity (\$/ft ²)	Natural Gas (\$/ft ²)	Total (\$/ft ²)	Savings (\$/ft ²)
1A Miami, Florida	3.62	0.02	3.63	3.53	0.01	3.54	0.09	3.37	0.01	3.37	0.26
2A Houston, Texas	3.67	0.04	3.70	3.56	0.03	3.58	0.12	3.39	0.02	3.41	0.30
2B Phoenix, Arizona	3.41	0.05	3.46	3.29	0.03	3.33	0.13	3.12	0.02	3.14	0.31
3A Atlanta, Georgia	3.38	0.11	3.49	3.26	0.08	3.34	0.14	3.09	0.06	3.15	0.34
3B Las Vegas, Nevada	3.21	0.08	3.29	3.11	0.05	3.16	0.13	2.95	0.03	2.98	0.31
3C San Francisco, California	3.06	0.06	3.12	2.98	0.04	3.02	0.10	2.84	0.02	2.86	0.26
4A Baltimore, Maryland	3.26	0.19	3.44	3.13	0.14	3.26	0.18	2.94	0.09	3.04	0.41
5A Chicago, Illinois	2.82	0.26	3.07	2.75	0.19	2.94	0.13	2.63	0.14	2.77	0.31
5B Boulder, Colorado	2.95	0.20	3.16	2.86	0.15	3.00	0.15	2.72	0.10	2.82	0.33
6A Minneapolis, Minnesota	2.87	0.34	3.21	2.80	0.26	3.06	0.15	2.69	0.20	2.89	0.32

Table 38: Estimated Simple Payback and Savings-to-Investment Ratio

Climate Zone	Low Utility Rate				Medium Utility Rate				High Utility Rate			
	Single-Pane Secondary		Double-Pane Secondary		Single-Pane Secondary		Double-Pane Secondary		Single-Pane Secondary		Double-Pane Secondary	
	Payback (yr)	SIR	Payback (yr)	SIR	Payback (yr)	SIR	Payback (yr)	SIR	Payback (yr)	SIR	Payback (yr)	SIR
1A Miami, Florida	44.6	0.4	20.4	1.0	30.9	0.6	14.1	1.4	19.5	1.0	8.9	2.2
2A Houston, Texas	34.0	0.6	17.6	1.1	23.7	0.8	12.2	1.6	15.1	1.3	7.7	2.6
2B Phoenix, Arizona	31.7	0.6	16.7	1.2	22.1	0.9	11.6	1.7	14.1	1.4	7.4	2.7
3A Atlanta, Georgia	28.1	0.7	15.3	1.3	19.8	1.0	10.7	1.9	12.7	1.6	6.8	2.9
3B Las Vegas, Nevada	30.9	0.6	16.9	1.2	21.7	0.9	11.8	1.7	13.9	1.4	7.5	2.7
3C San Francisco, California	39.2	0.5	19.8	1.0	27.5	0.7	13.8	1.4	17.6	1.1	8.8	2.3
4A Baltimore, Maryland	21.9	0.9	12.5	1.6	15.5	1.3	8.8	2.3	10.1	2.0	5.7	3.5
5A Chicago, Illinois	28.4	0.7	16.1	1.2	20.4	1.0	11.5	1.7	13.6	1.5	7.6	2.6
5B Boulder, Colorado	25.7	0.8	15.1	1.3	18.3	1.1	10.7	1.9	12.0	1.7	7.0	2.9
6A Minneapolis, Minnesota	25.3	0.8	15.1	1.3	18.2	1.1	10.8	1.9	12.2	1.6	7.1	2.8

Additional analysis was conducted to investigate if the single-pane secondary window with low SHGC (0.2), which could be offered by the manufacturer, could provide a good economic return in a warm climate zone (Climate Zone 1A) when compared to a double-pane secondary window with the same SHGC. The results presented in Table 39 show that the single-pane secondary window with low SHGC has lower payback and higher SIR than a double-pane secondary window at the same SHGC for Climate Zone 1A.

Table 39: Energy Savings of Single-Pane and Double-Pane Secondary Windows with Low SHGC for Climate Zone 1

	Single-Pane Secondary	Double-Pane Secondary
Energy Savings (kBtu)	3,659,683	3,580,465
Energy Cost Savings (\$)	107,657	104,935
Payback (yr)	8.41	11.01
SIR	2.38	1.82

IV. Summary Findings and Conclusions

This demonstration assessed the use of secondary windows for GSA applications. Several different evaluation criteria were used to assess the viability of secondary windows for GSA applications. Some of these assessments were performed with models, while others required onsite evaluations including time series measurements.

The secondary windows operated as intended and most evaluation criteria were met. The secondary windows can provide energy savings and can be cost effective due to improved thermal performance as compared to existing single-pane windows. Summary of results, findings and conclusions are outlined below.

- Secondary windows can be quickly and easily installed with existing windows to provide a cost-effective and efficient way to improve thermal performance and occupant comfort, especially for integration with existing single-pane windows.
- Secondary windows can be a substantially less expensive alternative to replacing primary windows. In addition, the secondary windows are lightweight and thus suitable for structures that cannot handle additional weight.
- The technology is particularly useful in buildings or areas where planning permission rules do not allow any aesthetic changes whatsoever to the external primary windows (e.g., historic buildings).
- Windows with the same U-value are manufactured with various levels of SHGC. SHGC should be appropriately selected for a climate zone. The lower the SHGC, the less solar heat it transmits and the greater its shading ability. A product with a high SHGC rating is more effective at collecting solar heat during the winter. A product with a low SHGC rating is more effective at reducing cooling loads during the summer by blocking heat gain from the sun.
- The calculated CR rating for the secondary window integrated with baseline single-pane window is 44–46, falling short of the criteria by a narrow margin. This may not necessarily be due to the secondary window, but rather to the existing single-pane window. Note: A window with a CR rating over 50 is considered to have good CR.
- The thermal comfort criteria are met as the results show that the majority of the indoor conditions were within the comfort boundary. However, the PMV and PPD analysis shows that the space in Building 53 was slightly cool and predicts that 45% of the occupants could experience local thermal discomfort. Thermal discomfort possibly already existed and may be caused by HVAC operation rather than the windows.
- Measured temperatures at the center of the glass during the coldest period show significant improvement with the secondary window. The average temperatures at the center of the glass of the double-pane and single-pane secondary windows during cold period (mean outdoor temperature at 21°F) are 68.2°F and 56.7°F, respectively, compared to the baselined single-pane window temperature of 48°F. Temperature differences increase radiant asymmetry, which contributes to occupant discomfort. ASHRAE 55 guidelines state that for vertical surfaces, radiant asymmetry should be kept to less than 18°F. In this circumstance, the vertical surface radiant asymmetry of the double-pane and single-pane secondary windows are within the ASHRAE guidelines. In addition, larger temperature differences between the window surface and indoor air can also induce convective heat transfer through air movement, particularly during cold conditions. Drafts caused by the air movement can also contribute to occupant discomfort.

- Most thermal comfort survey responses were positive and recommended the secondary window retrofit in the future. The secondary windows' appearance was noticeable but acceptable.
- To evaluate the deployment potential, energy savings and economic analyses were conducted for ten ASHRAE climate zones. The energy cost was estimated for three levels of GSA utility rates (low, medium, and high). The criteria were a payback period of less than 15 years and a SIR greater than 1 for both secondary windows. The results show that the double-pane secondary window is cost effective for most climate zones and at medium and high utility rates.
- For cold climates, the double-pane secondary window outperformed the single-pane secondary window and is broadly recommended. For warm climates, a single-pane secondary window with low SHGC is more cost effective.

References

1. Apte, J. and D. Arasteh. 2006. Window-Related Energy Consumption in the US Residential and Commercial Building Stock. Berkeley, CA: Lawrence Berkeley National Laboratory.
<https://facades.lbl.gov/publications/window-related-energy-consumption-us>.
2. ASHRAE. 2020. ANSI/ASHRAE Addendum d to ANSI/ASHRAE Standard 55-2017 Thermal Environmental Conditions for Human Occupancy.
https://www.ashrae.org/file%20library/technical%20resources/standards%20and%20guidelines/standards%20addenda/55_2017_d_20200731.pdf.
3. Curcija C., Goudey H., and Mitchell, R. 2017. "Low-e Applied Film Window Retrofit for Insulation and Solar Control."
4. Curcija C., Goudey H., Mitchell R., and Dickerhoff E. 2013. "Highly Insulating Window Panel Attachment Retrofit."
5. Deru M., Field K. Studer D., Benne K., Griffin B., and Torcellini P. "U.S. Department of Energy Commercial Reference Building Models of the National Building Stock."
6. Desjarlais, A.O., K.W. Child, and J.E. Christian. 1998. "To storm or not to storm: measurement method to quantify impact of exterior envelope airtightness on energy usage prior to construction."
7. Drumheller, S.C., C. Kohler, and S. Minen. 2007. "Field Evaluation of Low-E Storm Windows."
8. Fernandes L., Lee E., and Thanachareonkit, A. 2015. "Electrochromic Window Demonstration at the Donna Land Port of Entry."
9. General Services Administration. 2013. "Hi-R Low-e Window Retrofit System."
10. General Services Administration. 2014. "Electrochromic and Thermochromic Windows."
11. General Services Administration. 2016. "Denver Federal Center Long-term Space Strategic Plan."
12. Gowri, K., D. Winiarski, and R. Jarnagin. 2009. "Infiltration Modeling Guidelines for Commercial Building Energy Analysis." Bothell, WA: Pacific Northwest National Laboratory.
https://www.pnnl.gov/main/publications/external/technical_reports/PNNL-18898.pdf
13. Huizenga, C. 1999. "Window Performance for Human Thermal Comfort." Berkeley, CA: Lawrence Berkeley National Laboratory. <https://gaia.lbl.gov/btech/papers/44032.pdf>
14. Lee E., Fernandes L., Goudey H., Johnsson C., Curcija C., Pang X., DiBartolomeo D., and Hoffmann S. 2014. "A Pilot Demonstration of Electrochromic and Thermochromic Windows in the Denver Federal Center, Building 41, Denver, Colorado."
15. Lee E., Fernandes L., Touzani S., Thanachareonkit A., Pang X., and Dickerhoff D. 2016. "Electrochromic Window Demonstration at the 911 Federal Building, 911 Northeast 11th Avenue, Portland, Oregon."
16. U.S. Energy Information Administration. 2018. "Updated Buildings Sector Appliance and Equipment Costs and Efficiencies."
17. U.S. Department of Energy. 2019a. Better Buildings, Envelope Technology Research Team Webinar, Energy Savings Impact of Airtightness in U.S. Commercial Buildings, January 29, 2019.
https://betterbuildingsolutioncenter.energy.gov/sites/default/files/slides/ETRT%20Jan%202019_ALL%20Slides.pdf

18. U.S. Department of Energy. 2019b. Better Buildings Residential Network Peer Exchange Call Series: Window Treatments: The Undervalued, Highly Efficient Energy Efficiency Measure, November 14, 2019. <https://www.energy.gov/sites/prod/files/2019/12/f69/bbrn-window-treatments-111419.pdf>

WEBSITES

1. Alpen High Performance Products, <https://thinkalpen.com/>
2. Center for The Built Environment Thermal Comfort Tool, <https://comfort.cbe.berkeley.edu/>
3. DOE EnergyPlus, <https://energyplus.net/>
4. Lawrence Berkeley Laboratory THERM, <https://windows.lbl.gov/software/therm>
5. Lawrence Berkeley Laboratory WINDOW, <https://windows.lbl.gov/software/window>
6. OpenStudio, <https://www.openstudio.net/>
7. Minnesota Sustainable Housing Initiative, <http://www.mnshi.umn.edu/kb/scale/condensationresistance.html>
8. What is PMV and PPD? <https://www.simscale.com/blog/2019/09/what-is-pmv-ppd/>
9. Reading the AERC Energy Performance Certificate, <https://aercenergyrating.org/reading-the-commercial-label/>

Appendix A - Details of Secondary Windows

1. Single-pane secondary window

Frame: Low profile, long strand, pultruded fiberglass with foam insulation

Glass: Alpen ThinGlass (single pane) with applied safety film

2. Double-pane secondary window

Frame: Low profile, long strand, pultruded fiberglass with foam insulation

Glass: Micro IG unit - one pane of ThinGlass with applied safety film, and one pane of 1/8" Cardinal 366

Spacer: Warm edge

Gas: Krypton

Table 40: Performance Data for Single-Pane and Double-Pane Secondary Window

DATA	Existing 1/4" clear	Single-pane Secondary	Double-pane Secondary (180-K-1mm)	Double-pane Secondary (272-K-1mm)	Double-pane Secondary (366-K-1mm)
R-value (center of glass)	0.97	2.1	5.6	5.9	6.3
Winter u-value (center of glass)	1.03	0.48	0.18	0.17	0.16
SHGC	0.82	0.73	0.58	0.45	0.36
SC	0.84	0.84	0.67	0.52	0.41
Tvis	88%	81%	72%	65%	58%

Appendix B - Secondary Window Weight Comparison

Manufacturer-provided weight data for single-pane, single-pane secondary, double-pane, and double-pane secondary windows are presented in Table 41 and Table 42.

Table 41: Single-Pane Window Versus Single-Pane Secondary Window Weight Difference

Size	Area (ft ²)	Configuration		Single-Pane Secondary		Single-Pane Window		Single-Pane Window vs. Single-Pane Secondary Weight Difference
		Width (in)	Length (in)	Total Weight (lb)	lb/ft ²	Total Weight (lb)	lb/ft ²	
Small	10	30	48	12.3	1.2	36.3	3.6	2.95x
Medium	20	48	60	20.2	1.0	68.8	3.4	2.81x
Large	32	48	96	29.7	0.9	107.2	3.0	3.19x
Building 53	16.3	48.5	48.5	17.3	1.1	56.9	3.3	3.1x

Table 42: Double-Pane Window Versus Double-Pane Secondary Window Weight Difference

Size	Area (ft ²)	Configuration		Double-Pane Secondary		Double Pane Window		Double-pane Window vs. Double-Pane Secondary Weight Difference
		Width (in)	Length (in)	Total Weight (lb)	lb/ft ²	Total Weight (lb)	lb/ft ²	
Small	10	30	48	26.8	2.7	63.9	6.4	2.38x
Medium	20	48	60	50.4	2.5	125.5	6.3	2.48x
Large	32	48	96	103.3	3.2	199.1	6.2	1.96x
Building 53	16.3	48.5	48.5	41.8	2.6	102.9	6.3	2.46x

Appendix C - AERC Air Leakage Testing Results of Single- and Double-Pane Secondary Windows



AERC 1.2 Air Leakage Performance Test Report

Rendered To:

Alpen

Report No.:

QCT21-6427.01

Series/Product:

WinSert

Interior Secondary Insert

Test Date(s):

August 27, 2021 through September 2, 2021

Report Date:

September 2, 2021

QUAST CONSULTING AND TESTING, INC.

Exterior Façade/Fenestration Consulting Testing

1055 Indianhead Drive • Mosinee, WI 54455-0241 • Phone: 715-693-TEST (8378) • Fax: 715-693-0689

www.qct-usa.com

Document Control No.: 23.60-R16

QCT21-6427.01



Report Date: 09/02/21

Test Dates: 08/27/21

Through: 09/02/21

MANUFACTURER: Alpen
335-A Centennial Parkway
Louisville, CO 80027

SERIES/MODEL: WinSert
PRODUCT TYPE: Interior Secondary Insert

Summary of Results	
Test Procedure/Standard	Details
AERC 1.2 Air Leakage - WinSert Plus	0.3 L/s/m ² (0.06 cfm/ft ²) @ 75 Pa (1.57 psf), PASS
AERC 1.2 Air Leakage - WinSert Lite	0.3 L/s/m ² (0.06 cfm/ft ²) @ 75 Pa (1.57 psf), PASS

Reference Report No. QCT21-6427.01 for complete specimen description and test results.

QCT21-6427.01



Report Date: 09/02/21
Test Dates: 08/27/21
Through: 09/02/21

Project Summary:

Quast Consulting and Testing, Inc. was contracted by Alpen to perform testing per AERC 1.2 Air Leakage on a WinSert Interior Secondary Insert. The specimen was supplied by Alpen and was tested at Quast Consulting and Testing laboratory located in Mosinee, WI. Test specimen description and test results are reported herein.

Procedure:

Testing and reporting were conducted in accordance with:

AERC 1.2	<i>Physical Test Methods for Measureing Energy Performance Properties of Fenestration Products - Air Leakage</i>
ASTM E283-19	<i>Standard Test Method for Determining Rate of Air Leakage Through Exterior Windows, Curtain Walls, and Doors Under Specified Pressure Differences Across the Specimen</i>

Test Specimen Description:

Series/Model: WinSert
Product Type: Interior Secondary Insert
Overall Size: 1194 mm (47.00 in) wide x 1492 mm (58.75 in) high
Overall Area: 1.78m² (19.17ft²)

Frame Construction:

Fiberglass with mitered corner construction.

Weatherstripping Type:	Quantity	Location
Foam Filled Bulb	2	Continuous row at perimeter of frame.

Installation:

Insert window was installed into a test buck fitted with calibration panel. The rough opening of the test buck was 1200mm wide by 1500mm tall. The insert window was held in place with 4 temporary retaining clips. The insert window was installed on the inboard side of the calibration panel at a distance of 1.5" from the surface of the calibration panel.

QCT21-6427.01



Report Date: 09/02/21
Test Dates: 08/27/21
Through: 09/02/21

Test Results:

<u>Title of Test</u>	<u>Results</u>
Air Infiltration/Exfiltration per ASTM E283-19	
Calibration Panel Measured Leakage	2.0 cfm/ft ² 10.2 L/s/m ²
WinSert Plus - Dual Glazed	
Infiltration	
75 Pa	0.3 L/s/m ²
1.57 psf	0.06 cfm/ft ²
WinSert Lite - Single Glazed	
Infiltration	
75 Pa	0.3 L/s/m ²
1.57 psf	0.06 cfm/ft ²

QCT21-6427.01



Report Date: 09/02/21
Test Dates: 08/27/21
Through: 09/02/21

Test specimen drawings have been reviewed by Quast Consulting and Testing, Inc. and are representative of the test specimen reported herein. Material compositions were supplied by the manufacturer and were not verified by QCT.

List of Official Observers:

<u>Name:</u>	<u>Company:</u>
Brian Sasman	Quast Consulting and Testing, Inc.
Kelly Marlow	Quast Consulting and Testing, Inc.

The reported results were secured using the designated test methods. Test results relate only to the specimen tested. Statements of conformity are determined using the simple acceptance decision rule per ILAC-G8:09-2019. This report does not constitute certification of this product nor an opinion or endorsement by this laboratory. This report is the exclusive property of the client so named herein and may not be reproduced, except in full, without the written approval of Quast Consulting and Testing, Inc.

Electronic records of data sheets, drawings, correspondence, this report, or other pertinent project documentation will be retained for a period of 10 years from the test completion date. Physical representative samples of the test specimen will be retained for a period of 2 years from the test completion date. At the end of this retention period, such material shall be discarded without notice and the service life of this report will expire.

QUAST CONSULTING & TESTING, INC.

Handwritten signature of Brian M. Sasman in black ink.

Brian M. Sasman, P.E.
Author

QUAST CONSULTING & TESTING, INC.

Handwritten signature of Arlen Fisher in black ink.

Arlen Fisher, P.E.
Reviewer

Attachments: This report is complete only when all attachments listed are included.
Appendix A: As-Built Drawings (2 Pages)

Appendix D - Infrared Thermography Field Measurements

The main purpose of taking IR images of secondary windows as part of the study was to quantify the thermal gradient near the edge of glass. For overall monitoring, most thermocouples were attached to the glass and frame, but only one or two thermocouples were attached near the edge of glass for each monitored window. These point measurements are useful for comparison to thermal models. The IR images can provide pixel-by-pixel temperature measurements in a location where the temperature changes significantly in a small distance.

Figure 22 shows an IR image (left) of the two windows that were instrumented with thermocouples and the visual photo (right) of the same location. They were taken from the outside before sunrise on a cold morning. Figure 23 shows the IR image and visual photo taken of one of the same windows from the inside. The window frame appeared as a colder surface than the glass. In addition, reflections of people in the room near the window can be seen on the IR image. Most glass is specularly reflective in the IR; therefore, it is not as simple as one might imagine to measure glass temperature with an IR camera.

A strip of blue masking tape was adhered to the glass and frame as shown in Figure 24. It provides a surface that is not reflective and does not change the temperature of the glass very much. Figure 25 shows that surface temperature varied by almost 10°F over a small distance from the glass to the frame edge.



Figure 22: IR image (left) of the two windows outside and the visual photo (right) of the same location

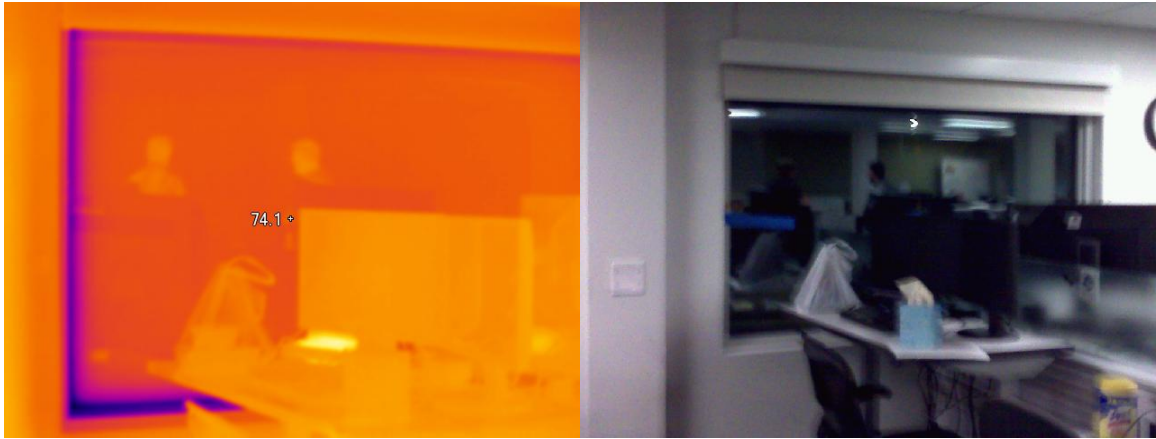

Figure 23: IR image (left) of the two windows inside and the visual photo (right) of the same location

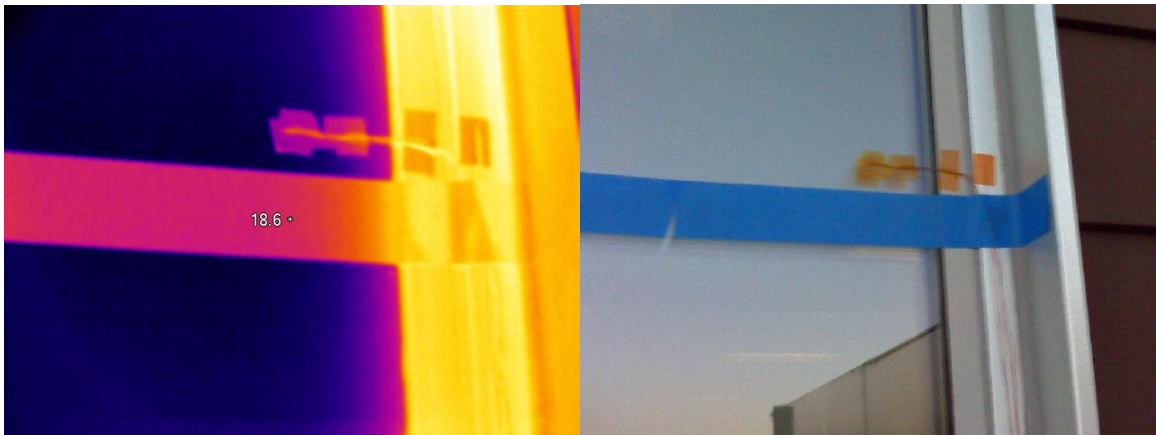

Figure 24: Thermocouples for temperature measurement on glass and frame

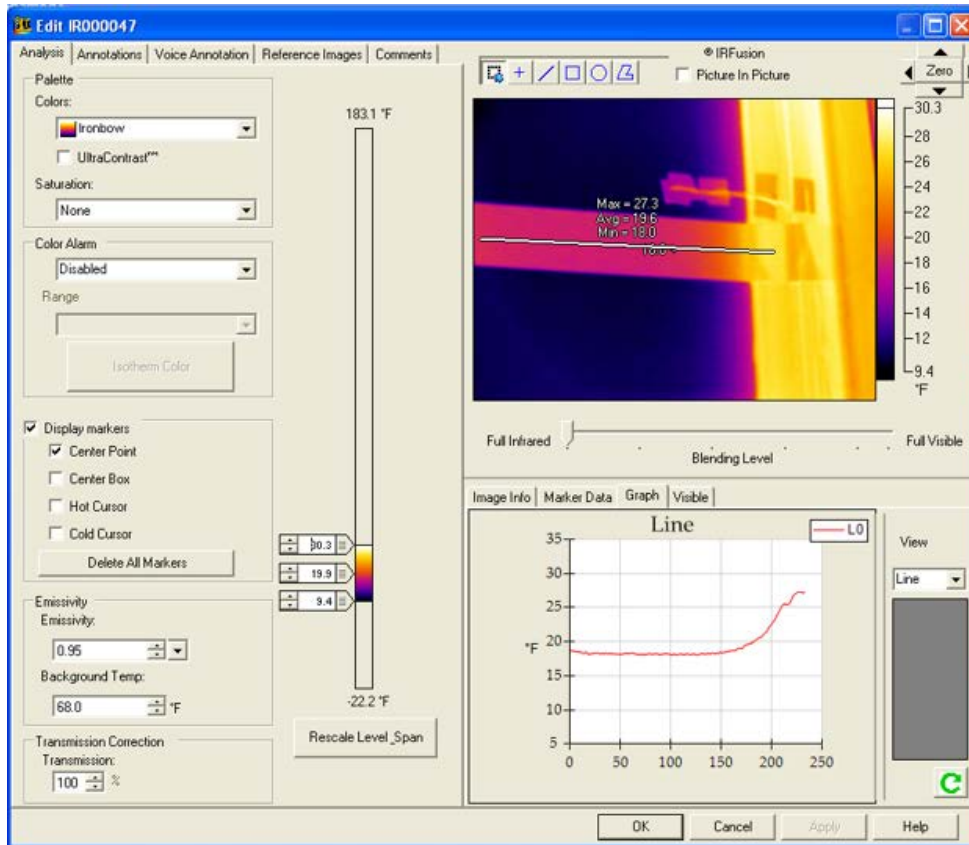

Figure 25: Surface temperature from the glass to the frame edge

Appendix E - EnergyPlus Modeling Assumptions

Table 43 summarizes the building characteristics of the DOE Commercial Reference Building Model for a large office. Three levels of GSA utility rates were used for economic and deployment potential analysis for the technology.

Table 43: Summary of EnergyPlus Model for Large Office

Large Office, 1980–2004 Vintage		
	Weather Data	Climate Zone 5B
	Building Type	Large office
	Total Number of Buildings Modeled	1
	Building Areas	498,588 ft ²
	Above-Grade Floors	12
Building Footprint	Building Orientation	Plan North
	Zoning Pattern	Perimeter and core zones
	Perimeter Zone Depth	30 ft
	Floor to Floor Height	14 ft
	Floor to Ceiling Height	10 ft
	Roof Pitch	0°, flat roof
Roof	Construction	Typical insulation entirely above deck roof
	Roof	
	Insulation	R-18.83
Walls	Construction	Typical insulated steel framed exterior wall
	Exterior Insulation	Effective R-6.29
Exterior Doors	Door Type	Typical insulated metal door
Exterior Windows	Window Type	Single pane window (baseline)
Window to Wall Ratio	Gross Window-Wall Ratio	38.05%
Building Operation	Schedule	7 a.m. to 5 p.m., Mon-Fri; closed on the weekends
Power Density	Lighting	1.50 W/ft ²
	Plug Loads	1.0 W/ft ²
HVAC Systems	System Type	Variable air volume system with hot water reheat

Large Office, 1980–2004 Vintage		
	Cooling System	Chilled water, chillers
	Chiller efficiency	0.7 kW/ton
	Heating System	Natural gas boiler
	Reheat Boiler efficiency	Hot water reheat 80%

Appendix F - Comfort Survey

GSA High Performance Windows Study – Comfort Survey

Instructions: Please check what applies and/or add clarification. Your name will not be mentioned in the results. The research team may follow up for additional information. If you have any question, please contact Kosol.Kiatreungwattana@nrel.gov

Name:
Email:
Phone:

- Where are you located?
 - Building 41
 - Building 53
- How close to a window do you sit to perform the majority of your work?
 - Less than 15 feet
 - 15–30 feet
 - Greater than 30 feet
- How often are you thermally uncomfortable? Please select all that apply.
 - Before retrofit
 - Frequently too cold (4+ times per week)
 - Occasionally too cold (1–2 times per week)
 - Usually comfortable
 - Occasionally too hot (1–2 times per week)
 - Frequently too hot (4+ times per week)
 - After retrofit
 - Frequently too cold (4+ times per week)
 - Occasionally too cold (1–2 times per week)
 - Usually comfortable
 - Occasionally too hot (1–2 times per week)
 - Frequently too hot (4+ times per week)
- Have you used a portable electric space heater in your workspace to increase comfort?

<u>Before retrofit</u>	<u>After retrofit</u>
<input type="checkbox"/> Yes	<input type="checkbox"/> Yes
<input type="checkbox"/> No	<input type="checkbox"/> No
- Have you used a fan in your workspace to increase comfort?

<u>Before retrofit</u>	<u>After retrofit</u>
<input type="checkbox"/> Yes	<input type="checkbox"/> Yes
<input type="checkbox"/> No	<input type="checkbox"/> No
- How many hours do you spend at your desk per day?
 - 1 to 3 hours

- 3 to 5 hours
- 5 to 8 hours
- 8 or more hours

7. What is your preferred position of the window in relation to your desk?

- Behind me
- To one of my sides
- In front of me, behind the computer screen

8. How often did windows cause visual discomfort such as glare?

Before retrofit

- Frequently too bright
- Occasionally too bright
- Never too bright

After retrofit

- Frequently too bright
- Occasionally too bright
- Never too bright

9. What is your preferred position for the window blinds in your workspace? Please select all that apply.

Before retrofit

- Up, clear window view
- Partially down
- Fully down
- No preference
- No window/blind in my workspace

After retrofit

- Up, clear window view
- Partially down
- Fully down
- No preference
- No window/blind in my workspace

10. How often do you adjust the position of the window blinds in your workspace?

Before retrofit

- Frequently adjust blinds
- Occasionally adjust blinds
- Never adjust blinds
- No window/blind in my workspace

After retrofit

- Frequently adjust blinds
- Occasionally adjust blinds
- Never adjust blinds
- No window/blind in my workspace

11. What factors motivate your adjustment of the window blinds in your workspace?

- Adjusting light level (glare control)
- Thermal management
- Privacy
- No window/blind in my workspace

12. Have you noticed the windows as being a cause of thermal discomfort before?

Before retrofit

- Yes, please describe:

- No

After retrofit

- Yes, please describe:

- No

13. What garments do you typically wear in the office in the winter?

- Jacket
- Light sweater or long-sleeved top
- Short-sleeved top

14. What is your gender?

- Male
- Female

15. If you were to guess your metabolic rate while working, it would resemble which of the following for the majority of the time?

- Seated, quiet
- Standing relaxed
- Walking slowly
- Typing
- Lifting/packing

16. How would you characterize the visual appearance of the window retrofit?

- No noticeable difference in appearance
- Noticeable, but acceptable difference in appearance
- Negative impact on appearance

17. Based on your experience with the window retrofit in your building, would you recommend similar retrofits elsewhere?

- Strongly recommend
- Recommend
- No opinion
- Do not recommend

Appendix G - Additional Results for Medium Office

Additional energy and economic analyses were conducted for the double-pane secondary window used in DOE’s Commercial Reference Building Model for a medium-sized office constructed before 1980. Medium GSA utility rates was used to estimate the energy cost savings, payback, and SIR. Table 44 presents estimated energy savings, payback, and SIR of the double-pane secondary window. Table 45 summarizes the building characteristics of the DOE Commercial Reference Building Model for a medium office. The results and findings are summarized below.

- Normalized energy savings from 8.1–15.6 kBtu/ft²/yr
- Total building energy reduction between 11% and 18%
- Normalized energy cost savings from \$0.27–\$0.54/ft²/yr for medium utility rate
- Payback period from 5.6–11.2 years for medium utility rate
- SIR from 1.6–3.2 for medium utility rate.

Table 44: Estimated Energy, Normalized Energy Savings, Payback, and SIR of Double-Pane Secondary Window for Pre-1980 Medium Office

	Single-Pane Baseline (kBtu/ ft ²)	Double-Pane Secondary (kBtu/ ft ²)	Savings (kBtu/ ft ²)	Whole Building Energy Savings (%)	Total Energy Cost Savings (\$)	Normalized Energy Cost Savings (\$/ ft ²)	Payback (yr)	SIR
1A Miami, Florida	74.7	66.6	8.1	11%	\$14,480	\$0.27	11.2	1.6
2A Houston, Texas	74.6	65.5	9.1	12%	\$16,088	\$0.30	10.1	1.8
2B Phoenix, Arizona	76.1	65.4	10.7	14%	\$19,031	\$0.35	8.7	2.1
3A Atlanta, Georgia	73.9	63.6	10.3	14%	\$18,770	\$0.35	8.7	2.1
3B Las Vegas, Nevada	72.5	61.7	10.8	15%	\$19,306	\$0.36	8.4	2.1
3C San Francisco, California	62.6	54.3	8.3	13%	\$15,016	\$0.28	10.8	1.6
4A Baltimore, Maryland	78.3	65.7	12.6	16%	\$23,060	\$0.43	7.1	2.5
5A Chicago, Illinois	81.1	67.6	13.5	17%	\$24,669	\$0.46	6.6	2.7
5B Boulder, Colorado	79.1	65.2	13.9	18%	\$25,205	\$0.47	6.5	2.8
6A Minneapolis, Minnesota	91.4	75.8	15.6	17%	\$28,959	\$0.54	5.6	3.2

Table 45: Summary of EnergyPlus Model for Medium Office

Medium Office, Pre-1980 Vintage		
	Weather Data	Climate Zone 5B
	Building Type	Medium office
	Total Number of Buildings Modeled	1
	Building Areas	53,628 ft ²
	Above-Grade Floors	3
Building Footprint	Building Orientation	Plan North
	Zoning Pattern	Perimeter and core zones
	Perimeter Zone Depth	30 ft
	Floor to Floor Height	14 ft
	Floor to Ceiling Height	10 ft
	Roof Pitch	0°, flat roof
Roof	Construction	Typical insulation entirely above deck roof
	Roof	
	Insulation	R-13.16
Walls	Construction	Typical insulated steel framed exterior wall
	Exterior Insulation	Effective R-6.21
Exterior Doors	Door Type	Typical insulated metal door
Exterior Windows	Window Type	Single pane window (baseline)
Window to Wall Ratio	Gross Window-Wall Ratio	33.01%
Building Operation	Schedule	7 a.m. to 5 p.m., Mon-Fri; closed on the weekends
Power Density	Lighting	1.57 W/ft ²
	Plug Loads	1.0 W/ft ²
HVAC Systems	System Type	Packaged variable air volume system
	Cooling System	Direct expansion
	Cooling Efficiency	3.22 COP
	Heating System	Natural gas furnace
	Furnace Efficiency	78%