

Prepared for the U.S. General Services Administration and the U.S.
Department of Energy by the National Renewable Energy Laboratory

SEPTEMBER 2018

High-Performance Circulator Pump Demonstration

Jesse Dean (NREL)

Anoop Honnekeri (NREL)

Greg Barker (Mountain Energy Partnership)

Disclaimer

This document was prepared as an account of work sponsored by the U.S. Government. While this document is believed to contain correct information, neither the U.S. Government nor any agency thereof, nor the National Renewable Energy Laboratory, nor any of their employees, makes any warranty, express or implied, or assumes any legal responsibility for the accuracy, completeness or usefulness of any information, apparatus, product or process disclosed or represents that its use would not infringe privately owned rights. Reference herein to any specific commercial product, process or service by its trade name, trademark, manufacturer or otherwise does not constitute or imply its endorsement, recommendation or favoring by the U.S. Government or any agency thereof or the National Renewable Energy Laboratory. The views and opinions of authors expressed herein do not necessarily state or reflect those of the U.S. Government or any agency thereof or the National Renewable Energy Laboratory.

The work described in this report was funded by the U.S. General Services Administration (GSA) and the U.S. Department of Energy (DOE) under Contract No. DE-AC36-08G028308.

Acknowledgements

The authors would like to thank the following people for the contributions to the pilot project and/or their review of this report.

GSA Region 8 (Building 810 and Building 67, Denver, Colorado): Tyler Cooper, Gregory Williams, and Gregg Brown

GSA's Proving Ground: Kevin Powell and Jay Fine

Tenfold Information Design Services: Andrea Silvestri

Grundfos Pumps: Stephen Putnam and Matt Baker

National Renewable Energy Laboratory: Michael Deru

Mountain Energy Partnership (MEP): Ed Hancock

This work was authored by the National Renewable Energy Laboratory, operated by Alliance for Sustainable Energy, LLC, for the U.S. Department of Energy (DOE) under Contract No. DE-AC36-08G028308. Funding provided by U.S. General Services Administration under Agreement IAG-14-01947. The views expressed do not necessarily represent the views of the DOE or the U.S. Government. The U.S. Government retains and the publisher, by accepting the work for publication, acknowledges that the U.S. Government retains a nonexclusive, paid-up, irrevocable, worldwide license to publish or reproduce the published form of this work, or allow others to do so, for U.S. Government purposes.

For more information contact:

Jesse Dean
Senior Engineer
National Renewable Energy Laboratory
Phone: 303-384-7539
Email: jesse.dean@nrel.gov

GSA's Proving Ground (GPG) program and DOE's High Impact Technology (HIT) Catalyst program enable federal and commercial building owners and operators to make sound investment decisions in next generation building technologies based on their real-world performance.

Executive Summary

This GSA Proving Ground (GPG) project assessed the performance of the Grundfos Magna 3 high-performance circulator pump (HPCP) at one heating hot water (HHW) application and two DHW applications at the Denver Federal Center (DFC) in Denver, Colorado. In commercial buildings, smaller circulator pumps are typically overlooked for energy efficiency upgrades due to their smaller size (typically less than 2.5 HP) and due to the lack of commercially available products that can simultaneously provide the combination of integrated controls and variable speed operation required to achieve acceptable energy savings and life cycle cost effectiveness. General Services Administration (GSA) facilities typically use constant volume circulator pumps for domestic hot water (DHW) recirculation loops, air handling unit (AHU) heating or cooling coil booster pumps, small radiant system heating pumps and smaller ground source heat pump applications.

Over 90% of the currently installed circulator pumps in the United States are constant volume pumps powered by standard induction motors. An Electric Power Research Institute (EPRI) report estimated the energy savings potential for the approximately 30 million installations of circulator pumps to be greater than 50% (Samotyj 2013).

Standard circulator pumps are constant speed, use a less efficient induction motor and are typically oversized in common heating, cooling and DHW applications. The HPCP is equipped with an electronically commutated motor (ECM) with electronic speed control based on the permanent magnet (PM) and compact stator motor technology and a built-in logic for energy optimization and energy management/reporting. The HPCP that was demonstrated also has various control modes, such as proportional pressure curve, AutoAdapt, FlowAdapt, constant pressure mode and constant curve mode, which can tailor the pump's operation to different system configurations. The HPCP includes a built-in flow meter, pressure gauges, British thermal units (BTU) meter and temperature sensor. A standard pump installation would require a pump, meter and communication equipment to be purchased as separate units that would need to be assembled and configured in the field to match the capabilities of the HPCP. Using wireless communication, the pump can also communicate with other HPCPs and a vendor-provided smart phone application.

Onsite submetering consisted of a combination of external data loggers, HPCP BACnet to NREL data logger communication and building automation system (BAS) trend logs. Electrical power, power factor, flow rate, fluid temperature, differential pressure (dP), outside air dry bulb, supply air temperature and DHW return temperature were all measured onsite and used to evaluate the performance of the pumps.

The primary objectives of the demonstration were to verify pump electricity savings and cost effectiveness, evaluate ease of installation and operability and ensure the DHW system was able to maintain desired return water temperature and the AHU was able to meet discharge air temperature set points. A summary of the quantitative and qualitative performance objective results is provided in Table 1.

Table 1 – Quantitative and Qualitative Performance Objective Results

QUANTITATIVE OBJECTIVES				
	METRICS & DATA	SUCCESS CRITERIA (For HHW and DHW application)	Results DHWPs	Results AHU 19 Pump
<i>Electricity Savings</i>	Metered electric consumption vs baseline pump	Greater than 50% electricity savings	<i>Met - DHW pump savings ranged from 90% to 96%</i>	<i>Not Met - HHW pump savings of 26%</i>
<i>Cost Effectiveness</i>	Simple payback period (SPP)	< 5 year payback > 1 Savings to Investment Ratio (SIR)	<i>Met - SPP of 3.7 to 4.3 years, SIR of 2.71 to 3.14</i>	<i>Partially Met - SPP of 6.41 years, SIR of 1.82</i>
<i>Meets Performance</i>	- AHU: Discharge air temperature setpoint - DHWP: Return water temperature setpoint	Air handling coil can meet discharge air temperature setpoint and DHWP can meet the return water temperature setpoint of 120°F.	<i>Met - DHW return temp set point, other than DHWP #1 (32-100)</i>	<i>Met - HHW Pump met AHU DAT</i>
QUALITATIVE OBJECTIVES				
<i>Ease of Installation</i>	- Interview with installer - Time required to install & configure - Labor associated with install	< 1 day to install < 4 hours to commission	<i>Met - Total installation and commissioning time of 5 hours per pump</i>	<i>Met - Total installation and commissioning time of 5 hours per pump</i>
<i>Operability</i>	- Interview with Operation and Maintenance (O&M) contractor - Usability opinion of facility operators	No impact to O&M effort	<i>Met - No adverse impact noted from pumps and O&M costs savings of \$75/yr</i>	<i>Met - No adverse impact noted from pumps and O&M costs savings of \$75/yr</i>

Building 67 at the DFC is a larger 14-story facility, and two DHW recirculation pumps (DHWPs) were retrofitted with HPCPs. The baseline DHWP-1 was a ¼ HP Armstrong pump with a maximum flow rate of 4.81 gallons per minute (gpm), a maximum differential pressure of 25.5 ft. and a measured pump power of 280 watts. This pump operated 8 hours per day, Monday–Friday and served DHW loads on the first floor of the facility. The baseline pump was replaced with an HPCP (Model 40-80) in early 2017 that was slightly larger than the baseline pump, approximately 0.37 versus the ¼ HP baseline pump. Baseline data was collected for the existing baseline pumps from February 15, 2017 to February 28, 2017, and the Model 40-80 HPCP was monitored from March 21, 2017 to May 26, 2017. The baseline period was short since the market standard pumps operate at the same power draw while operating. The Model 40-80 HPCP pump reduced energy usage by 90%, improved the power factor of the pump from 0.5 to 0.95 and was successfully able to meet the return water temperature set point. Although this pump had greater energy savings than expected, the pump was shown to be oversized due to the low wire-to-water efficiency and was replaced with a smaller, approximately ¼ HP, HPCP Model 32-100 when it became commercially available in the end of 2017. The smaller HPCP was monitored from December 18, 2017 to March 2, 2018. It was able to achieve greater energy savings at 96% for this case but did not respond correctly to the constant return water temperature control mode and had a lower power factor of around 0.37 at the low load at which it was operating. Further investigation after the demonstration revealed the pump was working correctly, but there was a wiring problem between the pump and the pump’s internal communication card, which caused it to not respond correctly to the return water temperature set point control. The DHWP-1 HPCP Model 32-100 was found to have an energy savings of 587 kWh/yr., an energy cost savings of \$58/yr. (with a blended electric rate of \$0.099/kWh), an

operation and maintenance (O&M) cost savings of \$75/yr., a simple payback of 4.3 years and a savings-to-investment ratio (SIR) of 2.71.

The baseline DHWP-2 was a ½ HP Armstrong pump with a maximum flow rate of 8.82 gpm, a maximum differential pressure of 25.82 ft. and a measured pump power of 370 watts. This pump operated 11 hours per day, Monday–Friday, 260 days per year and served DHW loads on floors 2–7 of the facility. The existing baseline pump was monitored from February 15, 2017 to March 6, 2017, and the HPCP (Model 40-80) was monitored from March 21, 2017 to May 26, 2017. The DHWP-2 HPCP Model 40-80 pump reduced energy usage by 94%, improved the power factor of the pump from 65% to 95% and was successfully able to meet the return water temperature set point. Although this pump had greater energy savings than expected, the pump was also shown to be oversized due to the low wire-to-water efficiency and was replaced with a smaller, approximately ¼ HP, HPCP Model 32-100 when it became commercially available in the end of 2017 and was monitored from December 18, 2017 to March 2, 2018. The smaller HPCP was able to achieve greater energy savings at 96% for this case and was able to meet the constant return water temperature set point but was also found to have a lower power factor that ranged from 36% to 85% based on pump speed. The DHWP-2 HPCP Model 32-100 was found to have an energy savings of 1,039 kWh/yr., an energy cost savings of \$79.5/yr. (with a blended electric rate of \$0.077/kWh), an annual O&M cost savings of \$75/yr., a simple payback of 3.7 years and a SIR of 3.14. For both of the DHWP retrofits, the new HPCPs had peak power reductions of greater than 50% while operating at full speed and were able to ramp down to very low loads when occupants were not using DHW.

AHU-17 in Building 810 at the DFC was selected as the baseline pump for HHW applications. The AHU was not operational at the time of the demonstration and was retrofitted with a market standard ½ HP Grundfos pump. The AHU-19 was retrofitted with a 0.36 HP HPCP. The AHU-17 and AHU-19 pumps are used as booster pumps for heating coils in the AHUs and operate from 3 to 24 hours per day, 7 days per week, for 7 months per year during the heating season. The AHU-19 pump had a three-way valve to account for the varying load, and a ball valve was installed on the bypass leg to eliminate flow through the bypass and effectively turn it into a two-way valve and allow for proper modulation of hot water flow with the new variable-speed HPCP. The AHU-17 pump was monitored as the baseline pump, and its energy usage was compared to AHU-19's HPCP. There were some initial problems with the AHUs not meeting discharge temperature set point that needed to be addressed by retro-commissioning the facility. Although the AHU-19 pump started responding correctly to the control signal after retro-commissioning the facility, AHU-19 serves an internal zone in the facility, and retro-commissioning resulted in very little run time for AHU-19 where it was primarily operating for a few hours each morning (2–3 hours per morning) and late afternoon and then switching over to cooling mode during the day. The AHU-19 HPCP was set up to operate using a simpler 0–10-volt (V) control sequence, rather than some of the onboard control sequences, due to delays in the project that were caused by needing to retro-commission the facility, which were identified after the demonstration started.

AHU-17 and AHU-19 were controlled to turn on and off based on a call for heating from the BAS. The energy savings were calculated based on 1-minute data over the monitoring period. The energy savings were calculated over the monitoring period from December 21, 2017 to March 2, 2018 and were 35% during on-peak periods and 24% during off-peak periods, with an overall savings of 25.7%. Contrary to the DHWPs that had peak power reductions of greater than 50%, the new market standard pump only had a 16% increase in peak power versus the HPCP, and this, in conjunction with the very low run time

of the AHU-19 (average of 4.99 hrs/day), resulted in lower overall energy savings than the two DHWP applications. The energy savings and economics for AHU-19 is very low on an annual basis, but onsite GSA staff estimated all HPCPs would save \$75/yr. in O&M costs because they do not require greasing of bearings or have pump seals that need to be replaced. A second case was created where the baseline pump was assumed to operate at 330 watts and the new HPCP had an average power draw of 132 watts, which operated on a schedule that was similar to AHU-17 at 20 hours per day to try to replicate a more typical heating system retrofit with an older market standard pump. In this case, the savings increase to 688 kWh/yr., the annual cost savings are \$41/yr., the O&M cost savings are \$75/yr., the simple payback is 4.29 years and the SIR is 2.71. The energy savings and economic analysis for all DHWPs and AHU cases are provided in Table 2.

Table 2 – DHWP and AHU Energy Savings and Economics

Category	DHWP #1 - Constant Temp. Model (40-80)	DHWP #1 - Constant Temp. (Model 32-100)	DHWP #2 - Constant Temp. (Model 40-80)	DHWP #2 - Constant Temp. (Model 32-100)	AHU 19	AHU 19 (w 60% save, 20 hrs/day)
Annual Energy Savings (kWh/yr.)	554	587	1,017	1,039	45	688
Annual Energy Cost Savings (\$)	\$18	\$19	\$35	\$36	\$1	\$23
Peak Demand Reduction (kW)	0.15	0.27	0.23	0.30	0.0176	0.08
Annual Demand Cost Savings (\$)	\$21	\$39	\$33	\$44	\$2	\$18
Total Annual Cost Savings (\$)	\$39	\$58.0	\$68.5	\$79.5	\$3	\$41
Blended Electric Rate (\$/kWh)	\$0.070	\$0.099	\$0.067	\$0.077	\$0.068	\$0.060
Annual O&M Cost Savings (\$)	\$75	\$75	\$75	\$75	\$75	\$75
Installed Cost (\$) [HPCP installed cost – standard pump installed cost]	\$829	\$575	\$829	\$575	\$500	\$500
Simple Payback	7.3	4.3	5.8	3.7	6.41	4.29
Net Present Value (\$)	\$512	\$988	\$857	\$1,240	\$420	\$865
Savings-to-Investment Ratio	1.61	2.71	2.02	3.14	1.82	2.71

The technicians who installed the pump estimated that it would take around 5 hours of labor to remove the old pump and install a new HPCP. The same technicians estimated 3 hours to remove a standard pump and install a standard pump, with the increased time requirements coming from the need to program the new HPCP and perform follow-up checks to make sure the controls are working correctly.

The study provided some valuable insights into the operation of the pump and its interaction with the system as a whole. Some of the lessons learned and best practices associated with the demonstration were: (1) three-way bypass valves need to be converted to two-way for heating applications where variable speed HPCPs are used, (2) right-size the new pumps to improve the performance of the pump and the economics, (3) adding new BAS points for these pumps is typically not required because it can more than double the installed cost of the pump, and the pumps have internal control modes that can be utilized to control the

speed of the pumps, (4) constant return water temperature control mode is preferable for DHWPs moving forward and (5) the building systems need to be commissioned and operating correctly before the pumps are installed.

Regarding deployment recommendations, DHWP recirculation pump installations resulted in the greatest energy savings and had a straightforward control system integration. DHWP recirculation pumps at other GSA sites likely have very irregular loads due to the intermittent schedule of hand washing and dishwashing, for example, and also have significant energy savings potential (pump can operate at lower pump speed and ramp up when water faucets are used). With the use of the smaller HPCP (less than 2.5 HP), the economics are favorable for end-of-life replacement with as little as 40 hours/week of pump operation given the low electric rates in Denver, Colorado.

Small heating system application economics are going to be impacted by the length of the heating season at the site, hours of operation per day and the local utility rates. Sites with older constant volume pumps with standard induction motors less than 2.5 HP that operate for more than 8–12 hours per day, 8 months per year, with electric rates of 11 cents/kWh or higher should be targeted. Small heating pumps that serve multiple heating coils are anticipated to have greater energy savings due to greater intermittent operation, longer run times and increased flow rate requirements.

Table of Contents

EXECUTIVE SUMMARY	ii
I. INTRODUCTION	1
A. WHAT WE STUDIED	1
B. WHY WE STUDIED IT	4
II. EVALUATION PLAN	4
A. EVALUATION DESIGN	4
B. TEST BED SITE	7
C. METHODOLOGY	12
III. DEMONSTRATION RESULTS	15
A. QUANTITATIVE RESULTS	15
B. QUALITATIVE RESULTS	45
IV. SUMMARY FINDINGS AND CONCLUSIONS	47
A. OVERALL TECHNOLOGY ASSESSMENT AT DEMONSTRATION FACILITY	47
B. LESSONS LEARNED AND BEST PRACTICES	47
C. DEPLOYMENT RECOMMENDATIONS	49
V. APPENDICES	50
A. CONTROL MODES	50
B. REFERENCES	51
C. GLOSSARY	51
D. MANUFACTURER CUT SHEET	52
VI. DEPLOYMENT GUIDANCE (GSA ONLY)	55
A. INSTALLATION AND COMMISSIONING	55
B. IMPACT ON FACILITY OPERATIONS	55
C. INFORMATION TECHNOLOGY SECURITY AND CONTINUITY OF CONNECTIVITY	55
D. TECHNOLOGY MARKET READINESS	55
E. TECHNOLOGY SPECIFICATIONS	55

I. Introduction

A. WHAT WE STUDIED

The majority of small circulator pumps that are currently being used in heating and cooling applications in existing commercial buildings are constant speed and use a standard induction motor that is less efficient than modern electronically commutated motors (ECMs). Because these pumping systems are typically constant volume, and the piping system usually includes a three-way valve that bypasses supply water around the heating and cooling coils when the heating and cooling capacity on the coil is less than 100%, the pump ends up using the same amount of energy regardless of the load on the system. New high-performance circulator pumps (HPCPs) are now commercially available that have the potential to reduce pumping energy usage for smaller 0.25–2.5 HP pumps.

The Grundfos Magna3 pump, which is an HPCP, was selected for a demonstration project at the General Services Administration (GSA) Denver Federal Center (DFC). The HPCP has several features that increase its range of operating conditions, improve its overall efficiency and equip it with integrated intelligence that provides more sophisticated control schemes than a standard pump (Figure 1).



Figure 1 – High-Performance Circulator Pump (Source: Grundfos)

There are 14 models of this specific HPCP with a maximum developed head of 60 ft. and a flow rate of 340 gallons per minute (gpm) at a head pressure of around 8 ft. (Figure 2). The numbers shown in Figure 2 represent different HPCP models that are recommended for each range of applicable head pressures and flow rates.

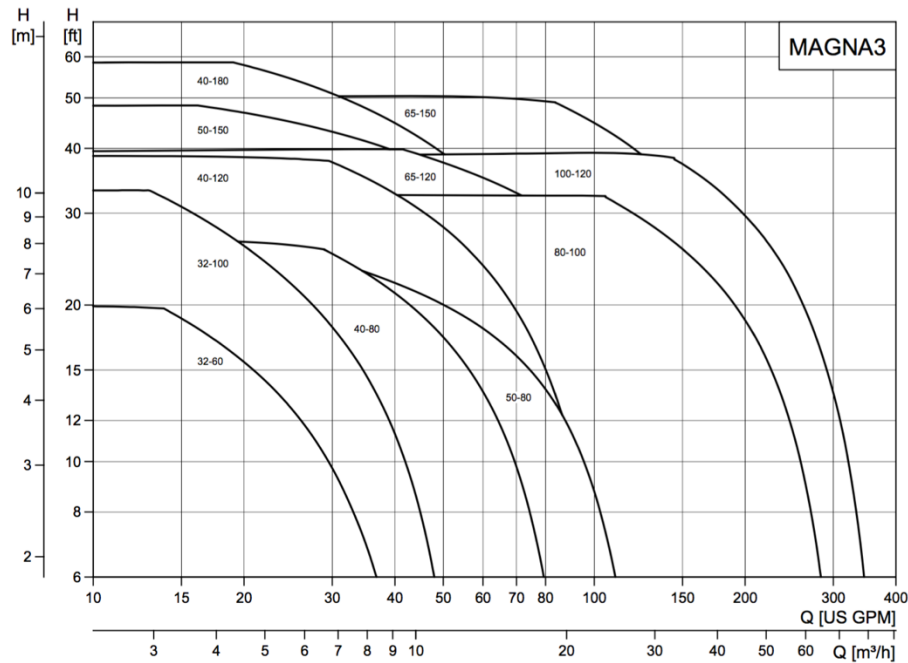

Figure 2 – HPCP Operating Range (Source: Grundfos)

A standard pump would need a meter and communication equipment to be purchased as separate units that would have to be assembled and configured in the field to match the capabilities of the HPCP. The HPCP includes a built-in flow meter, pressure gauges and temperature sensors. The unit comes with a built-in BACnet communication card and includes a built-in energy meter that monitors both electric and thermal energy consumption. Using wireless communication, the pump can communicate with other HPCPs and an HPCP smart phone application. The HPCP is equipped with electronic speed control based on permanent magnet (PM) and compact stator motor technology and built-in energy monitoring and controls that allow for energy optimization (i.e., the pump attempts to find the most efficient operating point based on the control mode). The pre-programmed control modes include proportional pressure, AutoAdapt, FlowAdapt, constant pressure, constant temperature and constant curve, which can tailor the pump’s operation to different system configurations (see Appendix A for details about each of the control modes). The three categories of claimed efficiency improvements for the HPCP are listed in Table 3, and the vendor estimates that the energy efficiency improvements over a standard circulator pump for the applications in this study are on the order of 50%–70%.

Table 3 – HPCP Efficiency Improvements (Morrison and Putnam 2016)

Technology Category	Efficiency Improvement
Optimized impeller design	10%–15% improvement in hydraulic efficiency
ECM with variable speed operation vs. induction motor	10%–20% electric efficiency improvement
Self-optimizing control logic and built-in nighttime setback	Up to 65% savings

Common applications for HPCPs are domestic hot water (DHW) recirculation systems, central heating systems, cooling system circulator pumps and ground source heat pump (GSHP) ground loop or building loop pumps. The HPCP size varies from 0.145 HP to 2.121 HP [110–1,582 watts for a 230-volt (V) model pump]. The maximum pump size of 2.121 HP is one of the limitations of this line of HPCPs. Pumps are generally slightly oversized due to a safety factor applied by the engineers in case actual pressure drops and flow rates are higher than the values estimated by the design engineer, and if the existing pump is oversized, HPCPs could potentially replace larger pumps up to 5 HP. HPCPs have an advantage over standard constant speed pumps in that they can ramp down to meet a lower flow rate and pressure drop based on the actual operating conditions of the pump, but oversizing the pump will result in a higher installed cost and lower wire-to-water efficiency than a right-sized pump. The upper limit operating range for the HPCP Model 40-80F and 32-100F pumps that were used in this demonstration is provided in Table 4. Because these are smaller pumps, the lower range is close to 0 gpm and 0 ft. of head (Grundfos n.d.).

Table 4 – Operating Range for HPCP Models 40-80F and 32-100F

Parameter	HPCP	HPCP
	Model 40-80F	Model 32-100F
Max. flow rate	80 gpm	57 gpm
Max. head	27 ft. water	32 ft. water
Max. power	262 watts	180 watts
Liquid temperature	+14 to +230°F	+14 to +230°F

Heating hot water (HHW) and DHW pumps (DHWPs) are installed in the majority of GSA’s larger facilities and GSA’s covered facilities; thus, this technology is scalable to a large portion of the GSA building portfolio. There are no site-specific constraints other than the pump size, which needs to be smaller than ~2.5 HP. This HPCP has been commercially available for 3 years and has undergone 1 million hours of testing before release and has a Technology Readiness Level (TRL) of 9.

B. WHY WE STUDIED IT

Pumping systems account for nearly 20% of the world’s energy used by electric motors and 25%–50% of the total electrical energy usage in certain industrial facilities (Hydraulic Institute et al. 2004). Significant opportunities exist to reduce pumping system energy consumption in small circulator pumps.

A previous Electric Power Research Institute (EPRI) report noted that, in the United States, there are approximately 30 million installations of circulator pumps with annual sales of approximately 3 million units. The energy savings potential in the United States for the sales of new circulator pumps is at least 4.75 TWh (EPRI test results), which reduces baseline energy consumption by 50% or more (Samotyi 2013). The HPCP vendor estimates that 90%–95% of the currently installed circulator pumps in the United States are the standard option and could be retrofitted with a more efficient HPCP.

II. Evaluation Plan

A. EVALUATION DESIGN

The primary objectives of the demonstration are to verify pump electricity savings and cost effectiveness [payback and savings-to-investment ratio (SIR)], evaluate ease of installation and operability and confirm that the system is still able to meet air handling unit (AHU) discharge air temperature (DAT) and DHW return water temperature set points. Quantitative and qualitative performance objectives for the project are provided in Table 5.

Table 5 – HPCP Quantitative and Qualitative Performance Objectives

Quantitative Objectives		
Objective Category	Metrics & Data	Success Criteria (For HHW And DHW Application)
Electricity Savings	Metered electric consumption vs. baseline pump	Greater than 50% electricity savings
Cost Effectiveness	Simple payback SIR	<10-year payback >1 SIR
Meets Performance	AHU: DAT set point; DHWP: Return water temperature set point	Air handling coil can meet DAT set point; DHWP can meet the return water temperature set point
QUALITATIVE OBJECTIVES		
Ease of Installation	Interview with installer; time required to install and configure; labor associated with install	<1 day to install <4 hours to commission
Operability	Interview with operation and maintenance (O&M) contractor; usability opinion of facility operators	No impact to O&M effort

Objective 1: Verify Pump Electricity Savings

The pump electricity consumption was evaluated during occupied and unoccupied hours under a combination of different control modes for the HHW and DHW applications. A listing of the various control modes that were evaluated is provided in Table 6.

Table 6 – HHW and DHW Applications—Control Modes

Application	Pump	Control Mode (Duration)
HHW	AHU-19	0–10-V DC
DHW	DHWP-1	AutoAdapt Constant temperature
DHW	DHWP-2	AutoAdapt Constant temperature

The following is a brief description of each control mode provided in Table 6:

- *0–10-V DC*: This control mode uses a 0–10-V DC signal directly from the BAS to control pump speed to meet a DAT set point.
- *AutoAdapt*: This control mode is internal to the pump and uses an automatic selector of the correct proportional pressure control curve within the pump. This is based on a measure of incoming power compared to the pump’s hydraulics that ensures minimum operation to meet system demand.
- *Constant temperature*: This control mode uses an internal temperature sensor within the pump to maintain a constant return water temperature for DHWP applications. This set point is typically set to 10°F below the DHW tank set point.

The quantitative parameters that were recorded to verify pump electricity savings are:

- Pump power
- Pump power factor
- Pump flow rate
- Pump differential pressure (for select pumps)
- Water temperature
- AHU DAT.

Pump power, power factor, flow rate, differential pressure for select pumps and water temperature were measured by the data acquisition system (DAS) installed by the National Renewable Energy Laboratory (NREL) and also through the metering systems that are built into the HPCPs. The secondary sub-metering system installed by NREL was used to verify the accuracy of the built-in HPCP metering systems and to calculate energy savings.

Objective 2: Verify Cost Effectiveness

The cost effectiveness was evaluated at the selected facilities based on the energy cost savings, retrofit/installation costs and O&M costs versus the incumbent technology. The manufacturer claims that the HPCP would have almost no maintenance costs, while the incumbent technology would have some maintenance costs for greasing motor bearings and replacement of worn seals. Overall cost

effectiveness was compared to the vendor's claims as a part of this demonstration. Payback was also evaluated under different utility rate structures. The success criterion for qualifying the product as cost effective is that it has a payback of less than 10 years and a SIR of greater than 1.

Objective 3: Air Handling Coil Can Meet DAT Set Point and DHWP Can Meet the Return Water Temperature Set Point

The HPCP ramps up and down to meet the load of the system on which it is installed. DAT at the air handler was measured to verify that the pump is providing adequate hot water to the air handler coil to meet set point. Similarly, the return water temperature on the DHW loop was measured to verify whether the pump is meeting the DHW set point.

Objective 4: Evaluate Ease of Installation and Operability

To evaluate the ease of installation, the time and labor required to install and configure the pump was documented. This is an important metric because the pump will be mostly installed in retrofit applications. The criterion for success was that it takes less than 1 day to install and less than 1 hour to commission.

Operability was evaluated by interviewing the onsite facilities' O&M staff. The criterion for success was that it should not introduce a steep learning curve and should not impact the regular O&M effort.

B. TEST BED SITE

The HPCP was evaluated at one HHW application and one DHW application at the DFC. The DFC houses 28 different agencies in 44 federal buildings. The HHW application was tested in Building 810, and the DHW application was tested in Building 67. The site selection requirements are provided in Table 7. Some of these site selection requirements would not be required or recommended for future GSA deployments and only focus on the criteria used to select an appropriate demonstration site.

Table 7 – High Performance Circulator Pump Site Requirements

SYSTEM	
Pump	Presence of a circulator pump (heating/cooling) with a redundant pump connected in parallel (pump size less than 2.5 HP). ^a
BAS	Presence of a building automation system (BAS) with which the HPCP is allowed to communicate via BACnet protocol (pump will need to be hard wired into the network). ^a
Flow Rate	Flow rate of existing circulator pump (heating/cooling) should be less than 150 gpm or a total dynamic head of 40 ft. Water temperature should be between 14°F and 230°F. ^a
Load	Presence of varying load in the DHW, heating or cooling system. ^a
Condition	System is in good operating condition. ^a
Documentation	Good documentation of: HVAC operational schedules and control settings (e.g., set points, sequence of operations of pumps and associated systems) Major variances from default building system schedules (e.g., overrides and system repair downtime) Current documentation of building HVAC system (e.g., up-to-date mechanical drawings and nameplate data). ^a
Configuration	The system is a recirculation loop and serves a heating, cooling or DHW application. ^b
Valves	The system has a three-way control valve with a manual shutoff valve on the bypass loop, or the existing circulator pump is variable speed with a variable frequency drive (VFD) and serves coils with two-way control valves (heating or cooling applications). ^b
Pump Isolation	The redundant pump can be isolated from the (heating/cooling) system, and the HPCP to be studied can be installed without shutting off water supply to the building. ^b
Sensors	Presence of a temperature and pressure sensor at pump inlet and outlet of the existing (heating/cooling) circulator pump. Both sensors should be connected to the BAS. ^b
BACnet	Energy management system (EMS) supports BACnet over internet protocol (IP). ^b

^a Required

^b Strongly preferred

Building Description

Building 810 has a gross area of 673,643 ft.² and was originally constructed in 1963. It is a mix of warehouse and office space (GSA 2017a). Building 67 is a 14-story high-rise concrete office building with a total area of 372,000 ft.² with 1,200 occupants and was constructed in 1967 (GSA 2017b).



Figure 3 – Building Locations



Figure 4 – Building 810 (Source: GSA)



Figure 5 – Building 67 (Source: Centerre Construction)

Climate Characteristics

Denver is a heating-dominated climate. Figure 6 shows the binned outdoor temperature from the Typical Meteorological Year (TMY3) weather data for Denver international airport. The outdoor temperature is less than 70°F for more than 80% of the total hours annually and Denver has 6,283 heating degree days with a base temperature of 65°F.

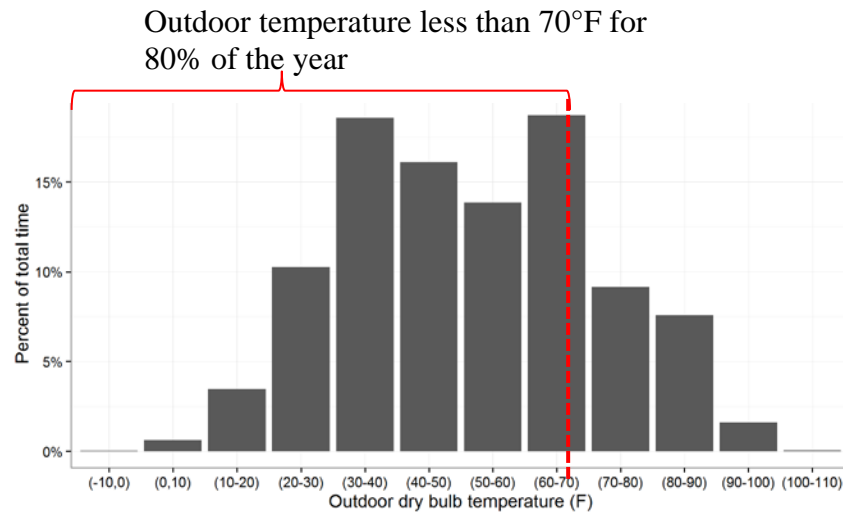

Figure 6 – Binned Outdoor Temperature

Building 67 – DHWPs

Building 67 has two DHWPs. DHWP-1 operates 8 hours per day, Monday–Friday, and DHWP-2 operates 11 hours per day, Monday–Friday, 260 days per year. These pumps originally serviced hot water recirculation from a large shell and tube steam to liquid heat exchanger. The heat exchanger is currently out of service, and the hot water is fed to a storage tank from the boiler (Figure 8 and Figure 9). DHWP-1 serves the cafeteria, and DHWP-2 serves the bathroom and kitchen sinks on floors 2–7.



Figure 7 – DHWP-1



Figure 8 – DHW Storage Tank



Figure 9 – DHW Supply and Return Lines

Building 810 – HHW Pumps

HHW pumps at Building 810 were included in this analysis. The hot water coils in AHU-17 and AHU-19 are served by two circulator pumps, operating 3–24 hours per day, 7 days per week for 7 months per year during the heating season. The AHU-19 pump had a three-way valve to account for the varying load (Figure 10). The bypass valve on AHU-19 was closed off to convert the three-way valve into a two-way valve to allow for proper operation with the HPCP. The AHU-17 pump was replaced with a market-standard Grundfos pump as the existing pump was not operational. The AHU-17 pump was monitored as the baseline pump, and its energy usage was compared to the HPCP installed on AHU-19 (Figure 11).

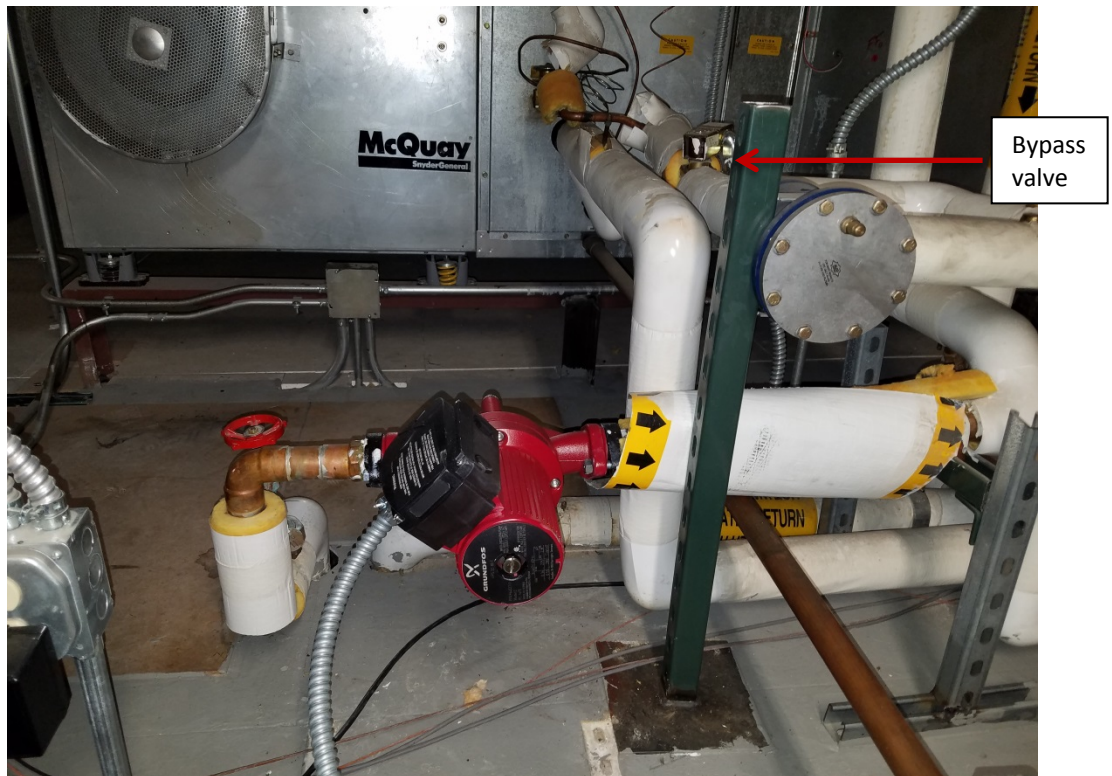

Figure 10 – AHU-17 Standard Circulator Pump and a Three-Way Valve

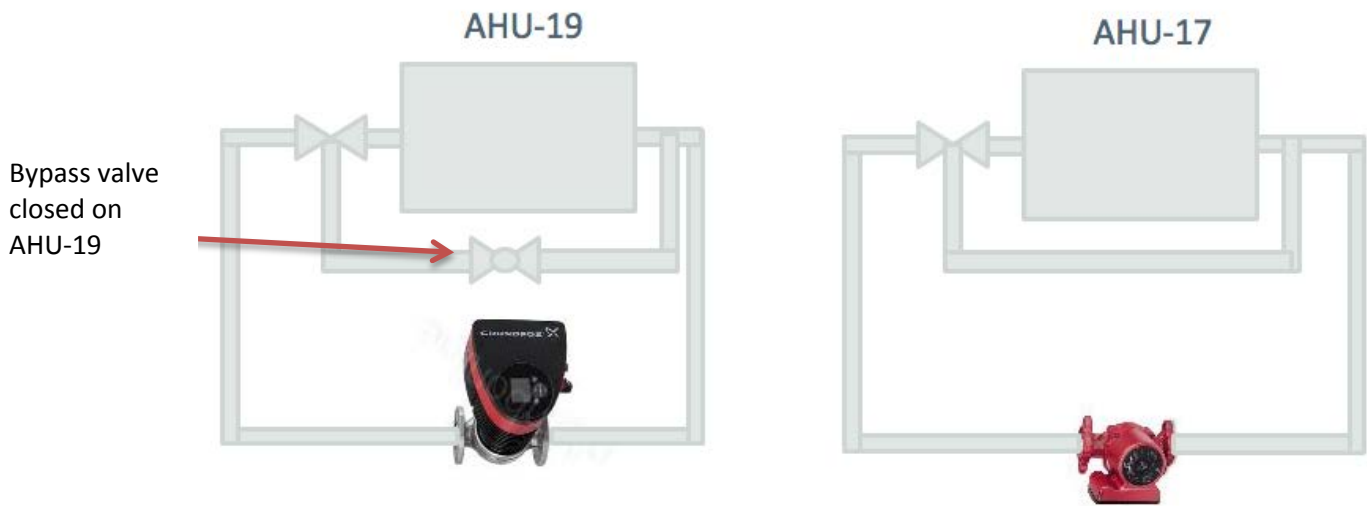

Figure 11 – AHU-19 and AHU-17 HPCP Layout

NREL installed instrumentation on an additional HHW pump that served heating coils in the ducts of one of the AHUs. The plan was to monitor the baseline performance of the pump and the new HPCP, but there was no load on the system and the pump was not operating during the monitoring period. This pump was, therefore, removed from the demonstration.

C. METHODOLOGY

Quantitative Study Design

DHWP-1 and DHWP-2 were monitored in series to characterize their energy savings and performance under two different control modes. The baseline data were collected for the existing pumps from February 15–29 for DHWP-1 and February 15–March 6 for DHWP-2. The baseline pump was replaced with the HPCP on March 3 for DHWP-1 and March 9 for DHWP-2. A second smaller HPCP was installed on each DHWP in November 2017 (Model 32-100) and was tested over a 3-month period. A listing of the control modes and duration for the DHWPs is provided in Table 8.

Table 8 – Control Mode and Duration for DHWPs, Building 67

Pump	Control Mode	Duration
DHWP-1 (Baseline)	Baseline	02/15/2017 to 02/28/2017
DHWP-1 (HPCP)	AutoAdapt	03/09/2017 to 03/19/2017
	Constant temperature (Model 40-80)	03/21/2017 to 5/26/2017
	Constant temperature (Model 32-100)	12/18/2017 to 3/2/2018
DHWP-2 (Baseline)	Baseline	02/15/2017 to 03/06/2017
DHWP-2 (HPCP)	AutoAdapt	03/09/2017 to 03/19/2017
	Constant temperature (Model 40-80)	3/21/2017 to 5/26/2017
	Constant temperature (Model 32-100)	12/18/2017 to 3/2/2018

Figure 12 shows a schematic of the sensor installation for the DHWPs.

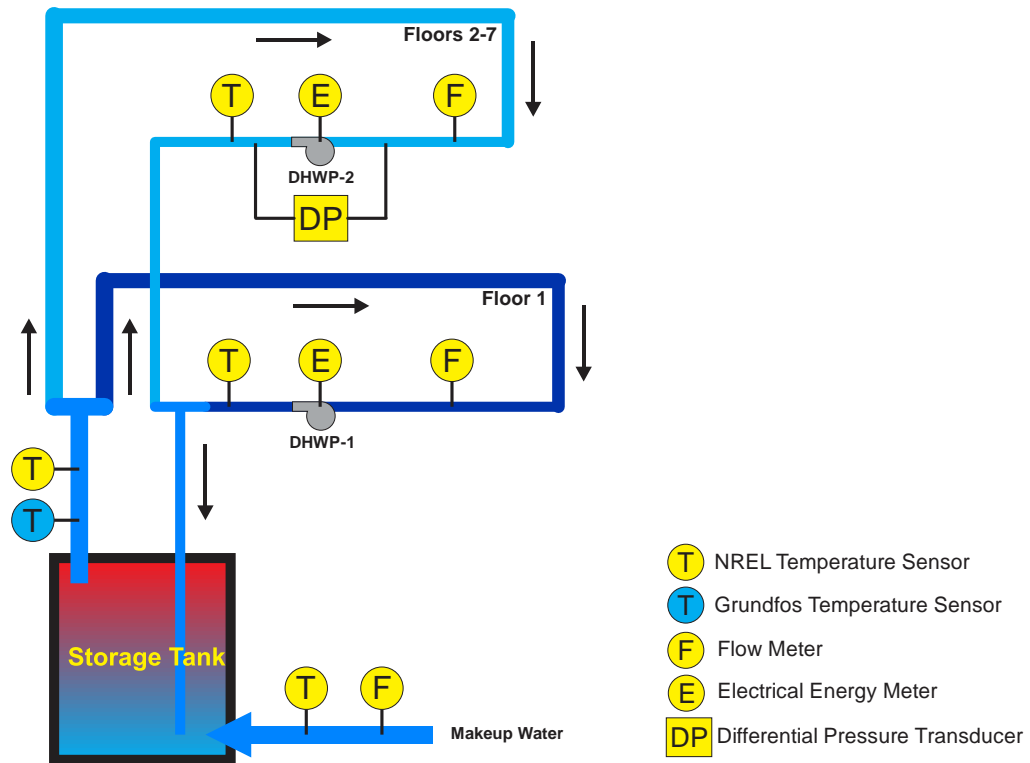

Figure 12 – DHWP Instrumentation Diagram (Image credit: Greg Barker, Mountain Energy Partnership)

The air handler pumps were monitored in parallel. The peak duty point flow rates of the AHU-17 baseline pump and AHU-19 HPCP were both approximately 12 gpm.

A listing of the monitoring periods and control modes for the HHW pumps in Building 810 is provided in Table 9, and a schematic of the sensor installation is shown in Figure 13.

Table 9 – Control Mode and Duration for HHW Pumps, Building 810

Application	Pump	Control Mode	Duration
AHU Heating Coil Booster Pump	AHU-17 (Baseline)	None	12/21/2017 to 2/21/2018 and 2/27/2018 to 3/2/2018
AHU Heating Coil Booster Pump	AHU-19 (HPCP)	0–10-V DC	12/21/2017 to 2/21/2018 and 2/27/2018 to 3/2/2018

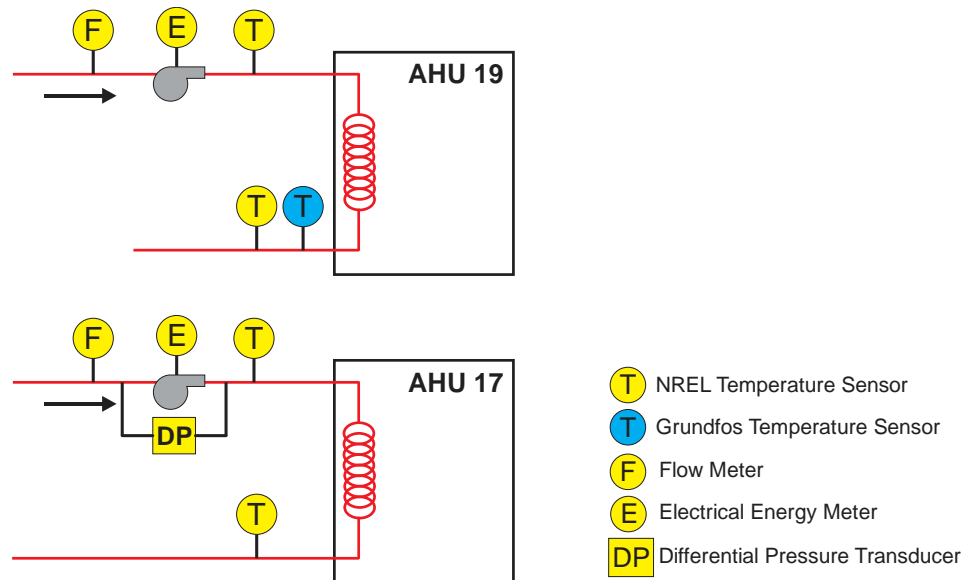

Figure 13 – HHW Pump Instrumentation Diagram (Image credit: Greg Barker, Mountain Energy Partnership)

Next, a high-level description of the monitoring points is provided for both the DHW and HHW applications.

Onsite Sub-Metering

- *Electrical power:* Power and power factor were monitored at each pump.
- *Flow rate:* An inline flow meter was installed that measured water flow rate through each pump.
- *Fluid temperature:* Immersed temperature sensors were installed to accurately measure fluid temperatures in and out of the pumps. External temperature sensors provided by the manufacturer were installed as feedback measurements to control the pumps and ensure the systems were able to meet the HHW and DHW loads.
- *Differential pressure:* The differential pressure across two pumps (AHU-17 pump and DHWP-2) were measured using differential pressure sensors. Differential pressure was monitored across only these two pumps because of funding constraints and the ability to use the HPCP internal differential pressure readings for AHU-19 and one of the DHPWs.

Building Automation System Trend Logs

- *Pump on/off status:* The pump on/off status for all four pumps was trended via the BAS at a recording interval of 15 minutes for HHW pumps.
- *Outside air dry-bulb:* Outside air dry-bulb temperature measurements were trended from the DFC BAS.
- *Supply air temperature:* Supply air temperature set points and supply air temperature readings were monitored for AHU-17 and AHU-19 to ensure that the pumps were able to meet the AHU heating load.
- *HPCP outputs:* Electrical power draw, flow rate, thermal energy, and any other relevant points from the HPCP were monitored by the NREL DASs using the Modbus communication protocol.

Data Acquisition System

- *DAS*: The *DAS* consisted of three standalone CR1000 Campbell Scientific data loggers.

A list of monitoring points, instruments and instrument accuracy is provided in Table 10.

Table 10 – Monitoring Points and Instrumentation

Monitoring Point	Instrument Description	Location	Instrument Accuracy
Pump power and power factor	Continental control systems watt node and Accu-CT	Building 810: two pumps; Building 67: two pumps	+/- 0.75%
Water flow rate	Omega Engineering turbine flow meters: FTB-8020 and FTB-4607	Building 810: two pumps; Building 67: two pumps; makeup water line	+/- 1.5% of reading
Supply water temperature	Immersed thermocouple	Building 810: two pumps; Building 67: two pumps	+/- 0.1°C
Differential pressure	Dwyer model 645 differential pressure sensor	AHU-17 and DHWP-2	+/- 0.43 kPa (+/- 0.144 ft.)

III. Demonstration Results

A. QUANTITATIVE RESULTS

DHWP-1 Operational Characteristics

The baseline DHWP-1 was an Armstrong circulator pump rated at ¼ HP, and DHWP-1 services DHW loads on the first floor of the facility. The first HPCP pump that was installed was a slightly larger HPCP rated at 0.37 HP, and the second HPCP that was installed was a smaller ~ ¼ HP pump. A stainless-steel version of the pump was installed because it was being used for a DHW application where potable water was flowing through the pump. The 115-V version of the pump was installed to match the electrical characteristics of the baseline pump. A high-level comparison of the two pumps at the peak duty point for the pump is provided in Table 11.

Table 11 – DHWP-1 Baseline and HPCP Characteristics

Characteristic	DHWP-1 Baseline	DHWP-1 HPCP (40-80)	DHWP-1 HPCP (32-100)
Manufacturer/Model	Armstrong 1050 – 1.25B – AB –	Magna3 40-80F Stainless Steel	Magna3 32-100F Stainless Steel
Pump Size	¼ HP	0.37 HP	¼ HP
Pump Voltage	115 V/1 Ph	115–230 V	115–230 V
Impeller Size	4.75” max. impeller trim	N/A	N/A
Motor Speed (rpm)	1,800	3,220	3,875
Duty Point Flow Rate (gpm)	4.81	4.81	4.81
Duty Point Power (watts)	280	157	77
Duty Point Differential Pressure (DP-ft.)	25.5	25.5	25.5
Wire-to-Water Efficiency	8.2%	14.5%	30.1%
Area Served	Floor 1	Floor 1	Floor 1
Weekday Start and Stop Time	6 a.m.–2 p.m.	6 a.m.–2 p.m.	6 a.m.–2 p.m.
Weekend Start and Stop Time	Off all weekend	Off all weekend	Off all weekend
Control Modes Tested	-	AutoAdapt and constant temperature	Constant temperature

The duty point power of HPCP Model 40-80F was substantially lower (157 watts vs. 280 watts) than the baseline pump, and the smaller HPCP Model 32-100F has a duty point power that is about 50% lower than the larger pump at 76.8 watts. Both HPCP models would result in significant energy savings even if the HPCP ran at close to 100% duty point speed continuously. The flow rate versus differential pressure for the baseline pump and new HPCP were plotted to determine the peak duty point flow rate, duty point power and duty point differential pressure. At its peak energy use condition, the baseline pump had a low flow rate and high corresponding differential pressure and, consequently, operated at a very poor point on the pump curve for the baseline pump and had a very low wire-to-water efficiency (pump efficiency x motor efficiency of 8.2%). At this same duty point, the HPCP had a calculated wire-to-water efficiency of 14.5%, which is considerably better but is still operating at a low efficiency point on the HPCP curve because it typically has a much higher wire-to-water efficiency when operating at a higher flow rate and lower differential pressure.

Thus, a smaller HPCP was installed that had a wire-to-water efficiency of 30.1%. The Armstrong 1050-1.25B pump curve is provided in Figure 14 with a red dot illustrating the calculated duty point on the curve.

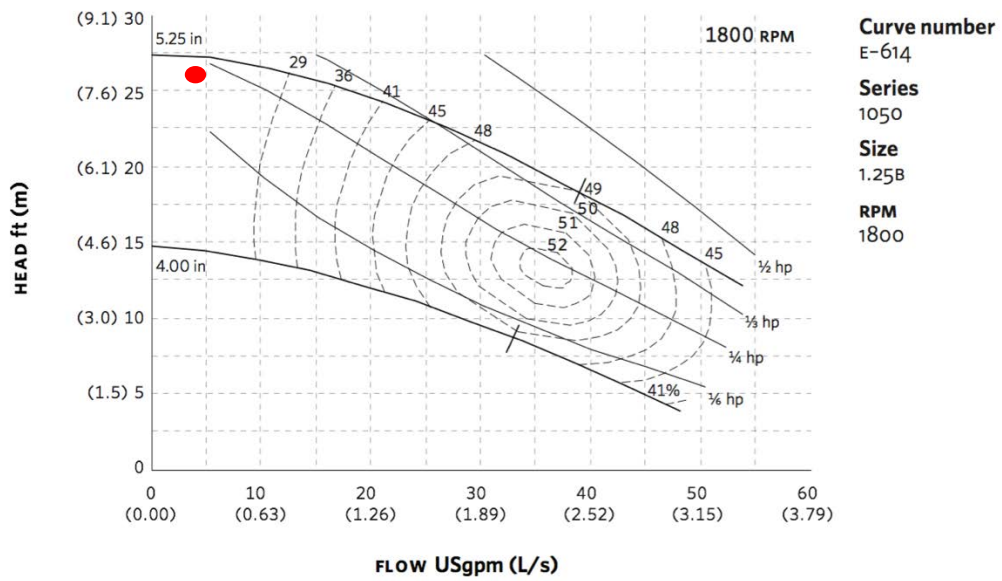

Figure 14 – Armstrong 1050 – 1.25B Pump Curve

Pump curves for HPCP Model 40-80 are provided in Figure 15, and the duty point is at 97% of the maximum pump speed, or 4,065 rpm.

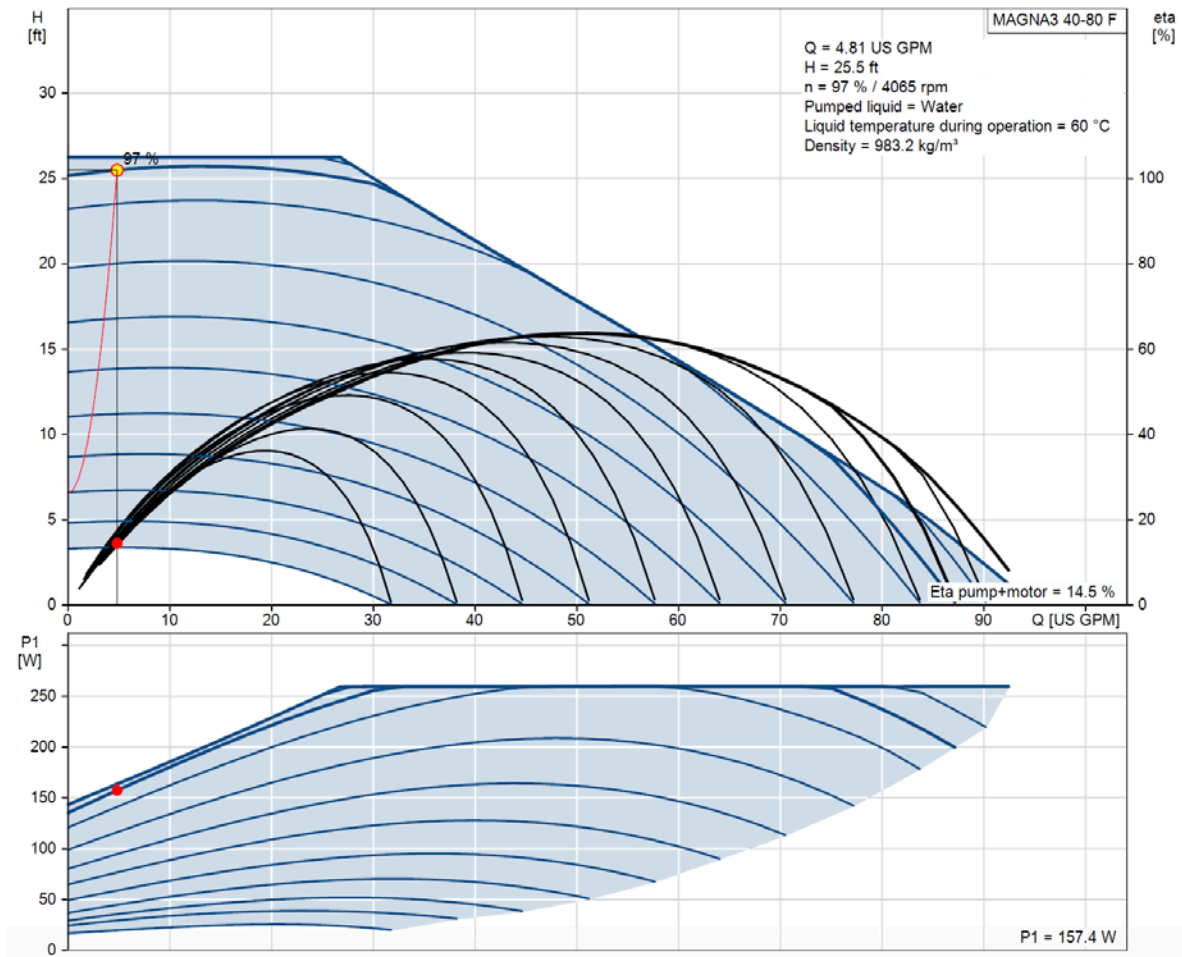

Figure 15 – DHWP-1 – HPCP Model 40-80 Pump Curves (Source: <https://product-selection.grundfos.com/catalogue.html>)

As noted in Table 11, the wire-to-water efficiency at this point is 14.5%. The very low wire-to-water efficiencies and poor operating point on the pump curve indicate that the pump was oversized, but the ¼ HP pump was the smallest pump that the HPCP manufacturer was selling at the time. A smaller version of the HPCP became available in Q4 2017 and improved the wire-to-water efficiency to 30.1%. A picture of DHWP-1 post-retrofit is provided in Figure 16.



Figure 16 – DHWP-1 HPCP Model 40-80F

DHWP-2 Operational Characteristics

The baseline DHWP-2 was an Armstrong circulator pump rated at $\frac{1}{2}$ HP that services DHW loads on floors 2–7 of the facility. The HPCP that was installed for DHWP-2 was slightly smaller than the baseline pump (0.37 HP vs. 0.5 HP) but was found to be still slightly oversized due to low wire-to-water efficiency and was also replaced with a smaller HPCP at the end of 2017. Similar to DHWP-1, a stainless-steel version was installed because of the DHW application, and the 115-V version of the pump was installed to match the electrical characteristics of the baseline pump. A high-level comparison of the three pumps at the peak duty point for the pump is provided in Table 12.

Table 12 – DHWP-2 Baseline and HPCP Characteristics

Characteristic	DHWP-2 Baseline	DHWP-2 HPCP (40-80)	DHWP-2 HPCP (32-100)
Manufacturer/Model	Armstrong H-53 – AB	Magna3 40-80F, Stainless Steel, 120 V	Magna3 32-100F Stainless Steel
Pump Size	½ HP	0.37 HP	¼ HP
Pump Voltage	115 V/1 Ph	115–230 V	115–230 V
Impeller Size	5.25	N/A	N/A
Motor Speed (rpm)	Unknown	4,077	3,857
Duty Point Flow Rate (gpm)	8.82	8.82	8.82
Duty Point Power (watts)	370	176	97
Duty Point DP (ft.)	25.82	25.82	25.5
Wire-to-Water Efficiency	<i>Unknown</i>	23.9%	44.3%
Area Served	Floors 2–7	Floors 2–7	Floors 2–7
Weekday Start and Stop Time	6 a.m.–5 p.m.	6 a.m.–5 p.m.	6 a.m.–5 p.m.
Weekend Start and Stop Time	Off all weekend	Off all weekend	Off all weekend
Control Modes Tested	–	AutoAdapt and constant temperature	Constant Temperature

Because DHWP-2 services floors 2–7 of the facility, it has roughly twice the peak flow rate of DHWP-1. The duty point power of 176 watts for the HPCP was substantially lower than the baseline pump at 370 watts and even lower for the HPCP Model 32-100 pump at 96.78 watts. The maximum flow rate was measured to be 8.82 gpm, with a corresponding differential pressure of 25.82 ft. At its peak conditions, this pump also has a low flow rate and high differential pressure but is able to operate at a more efficient point on the HPCP curve compared to DHWP-1, and the smaller HPCP operates at a much higher wire-to-water efficiency at 44.3%. For the baseline Armstrong pump, the manufacturer did not provide a detailed pump curve with pump efficiencies and impeller sizes. Therefore, a wire-to-water efficiency could not be calculated for the baseline pump. A generic pump curve for the Armstrong H-53-AB pump is provided in Figure 17, and a pump curve for the HPCP is shown in Figure 18.

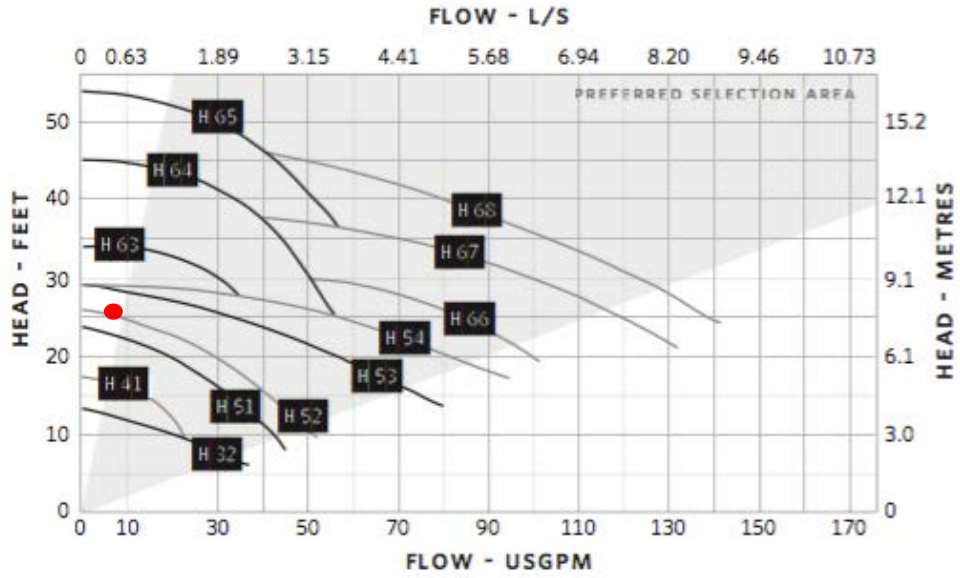

Figure 17 – Armstrong H-53 AB Pump Curves

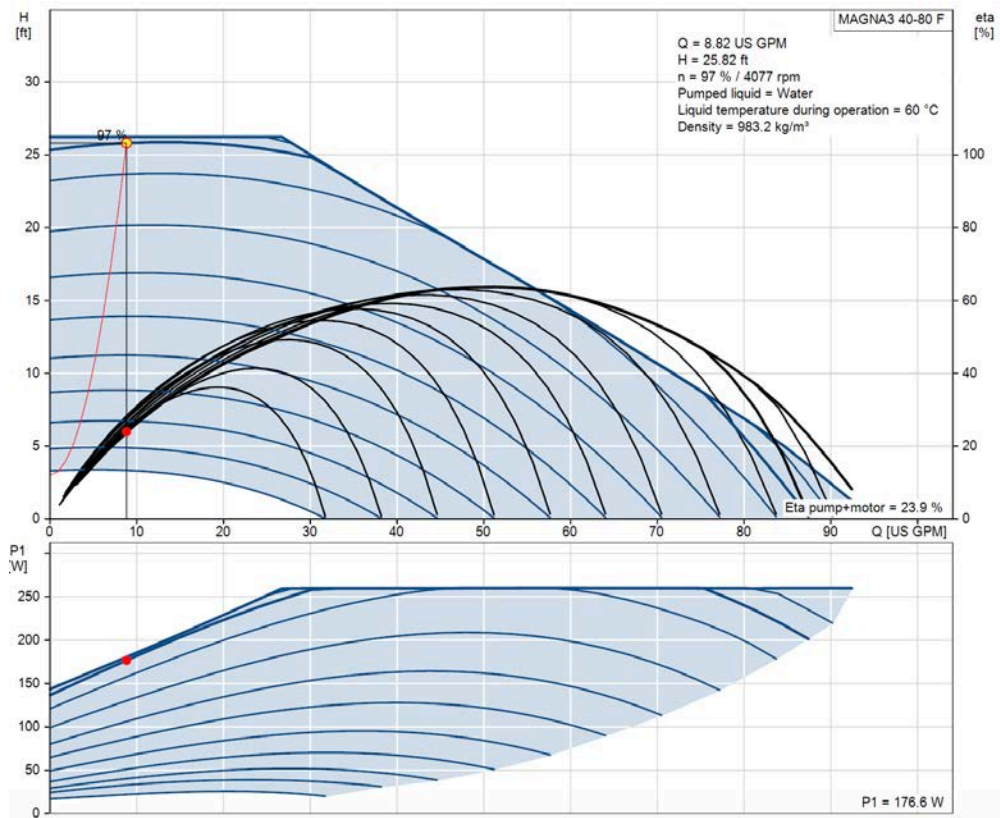

Figure 18 – DHWP-2 – HPCP Model 40-80 Pump Curves (Source: <https://product-selection.grundfos.com/catalogue.html>)

A picture of DHWP-2 post-installation (HPCP Model 40-80) is provided in Figure 19.



Figure 19 – DHWP-2 HPCP Model 40-80

AHU-17 and AHU-19 Operational Characteristics

The existing pump that was serving AHU-17 was not operational and needed to be replaced. Because AHU-17 and AHU-19 were going to be monitored in parallel, a market standard ½ HP, constant speed pump was installed for AHU-17, and an HPCP was installed for AHU-19. The 230-V cast iron version of the HPCP was installed because it was not a potable water application and did not need to be stainless steel. A high-level comparison of the two pumps at the peak duty point for the pump is provided in Table 13.

Table 13 – AHU-17 and AHU-19 Pump Characteristics

Characteristic	AHU-17	AHU-19
Manufacturer/Model	Grundfos UPS 32-80/2	Magna3 40-80F, cast iron, 230 V
Pump Size	½ HP	0.36 HP
Pump Voltage	480 V/3 Ph	230 V/1 Ph
Impeller Size	Unknown	Unknown
Motor Speed	Unknown	3,909
Duty Point Flow Rate (gpm)	12.5	12.5
Duty Point Power (watts)	224	186
Duty Point DP (ft.)	24	24
Wire-to-Water Efficiency	24%	29.8%
Weekday Start and Stop Time	On 24/7 Heating season (Oct.–May)	On 24/7 Heating season (Oct.–May)
Weekend Start and Stop Time	On 24/7 Heating season (Oct.–May)	On 24/7 Heating season (Oct.–May)
Control Modes Tested	–	0–10 V DC

The peak duty point and flow rates for the two pumps were very similar. Using a flow rate of 12.5 gpm and a differential pressure of 24 ft., the baseline pump has a rated power of 223.6 watts and the HPCP has a rated power of 186 watts, representing a 16.8% reduction in peak power and a reduction of 37.6 watts. Pump curves for the baseline pump and HPCP are shown in Figure 20 and Figure 21, respectively.

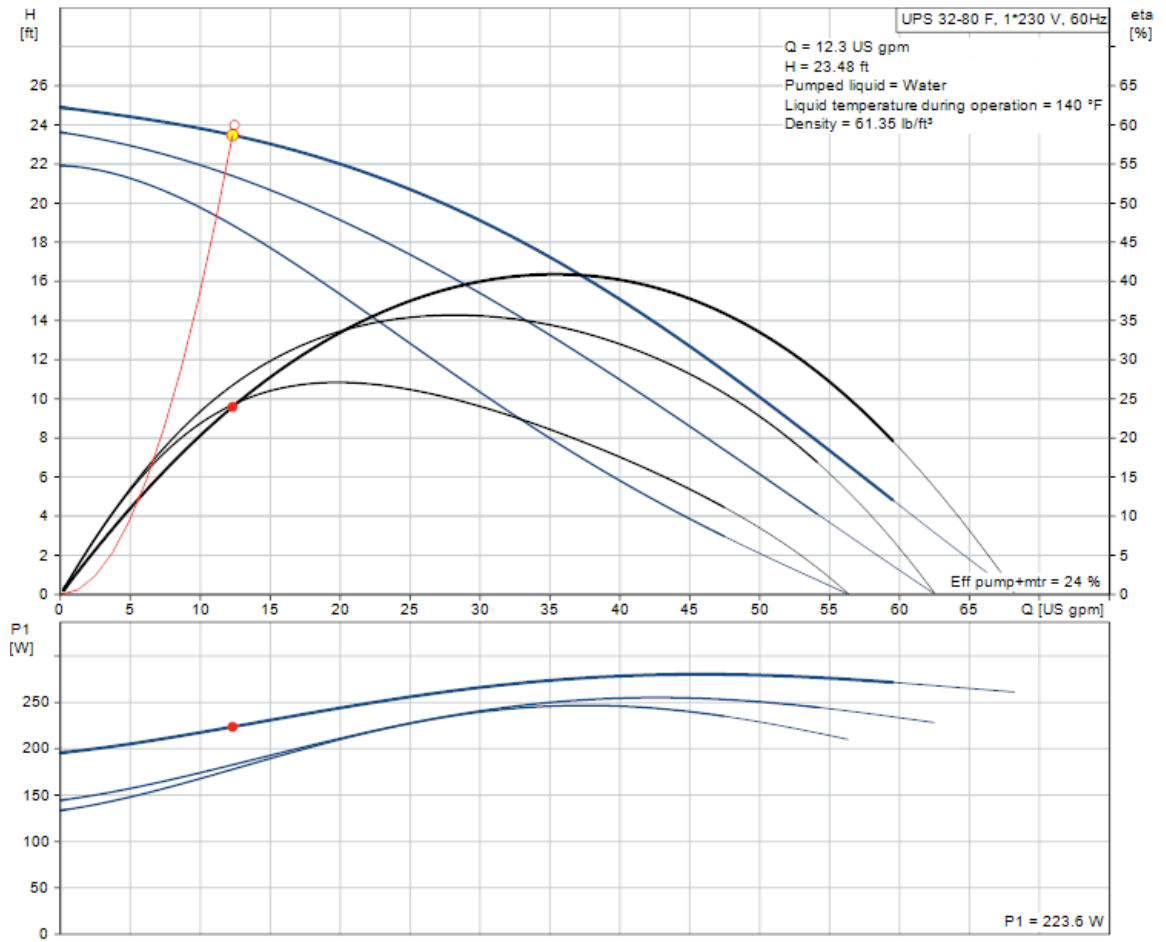

Figure 20 – Grundfos UPS 32-80/2 Pump Curve (Source: <https://product-selection.grundfos.com/catalogue.html>)

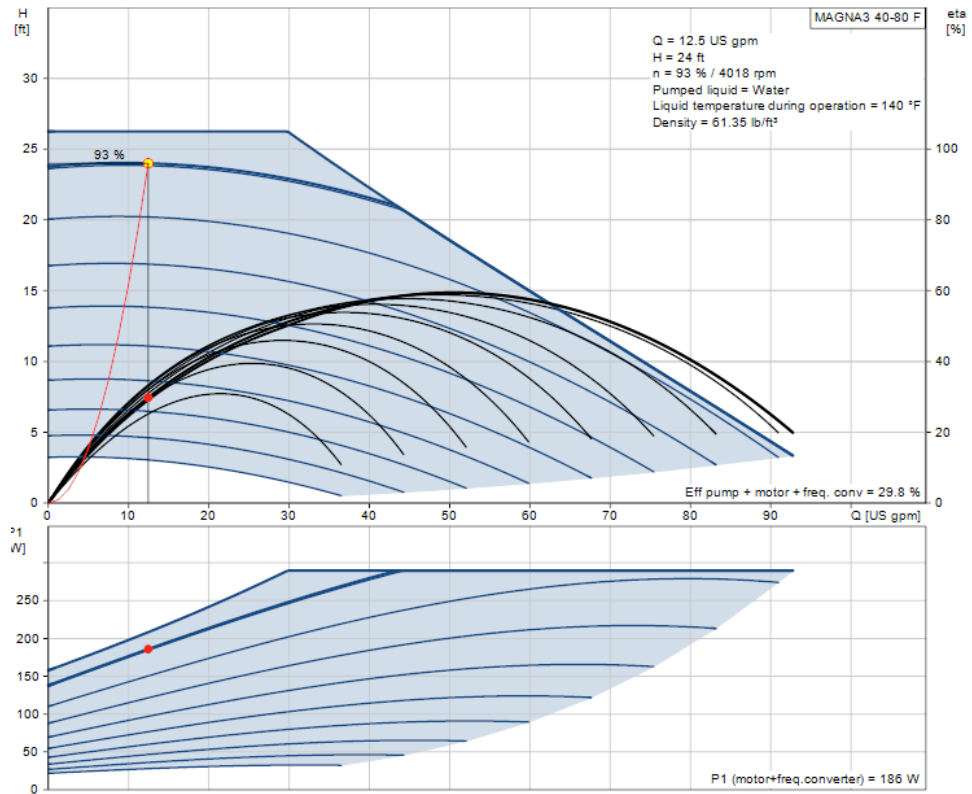

Figure 21 – AHU-19 – HPCP Model 40-80 Pump Curve (Source: <https://product-selection.grundfos.com/catalogue.html>)

A picture of the HPCP installed on AHU-19 is shown in Figure 22.



Figure 22 – AHU-19 HPCP

Objective 1: Verify Pump Electricity Savings

DHWP-1

The measured power consumption and flow rate for DHWP-1, using 15-minute data, are provided in Figure 23. Figure 23 also shows the average power and flow rate for the baseline pump, HPCP Model 40-80 and HPCP Model 32-100, while operating in a constant return water temperature mode.

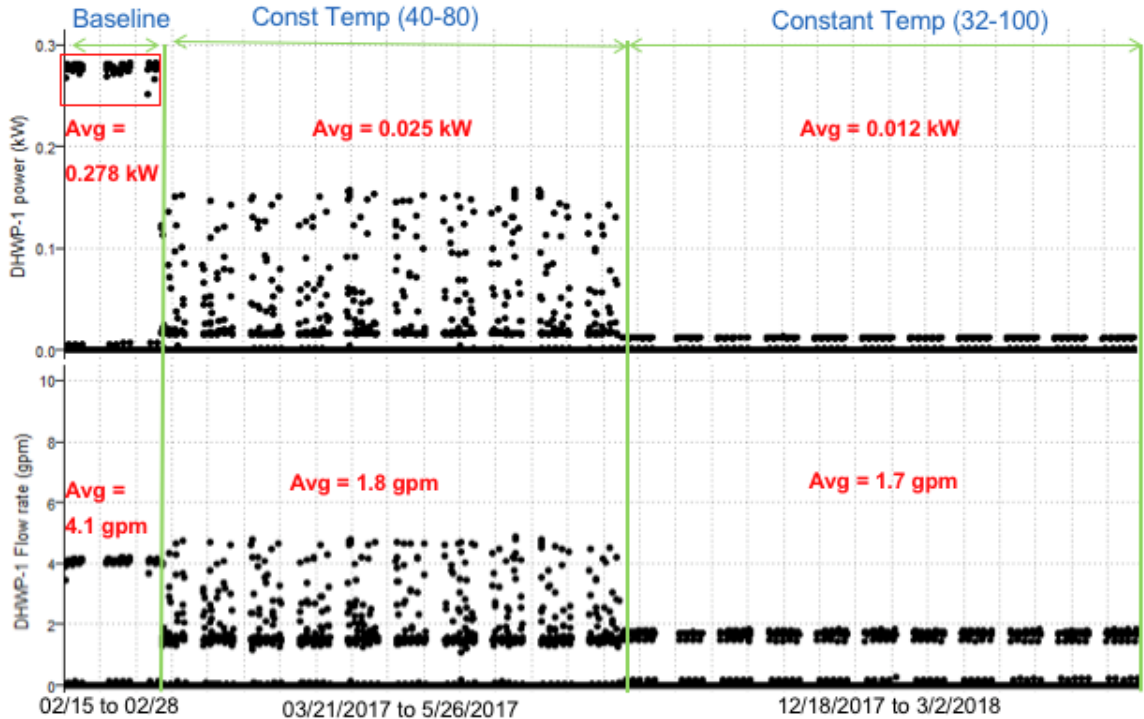

Figure 23 – DHWP-1 Power and Flow

The average power consumption of the baseline DHWP-1 (measured when the pump was on) was 0.278 kW, and the average flow rate was 4.1 gpm. The HPCP was programmed to run initially in AutoAdapt control mode, and the average power was reduced by 91% (0.026 kW), compared to the baseline pump while the flow rate was reduced by 49% (2.1 gpm). In the AutoAdapt control mode, the pump was not modulating correctly because it did not have the appropriate control signal to respond to. The HPCP was then operated in the constant temperature control mode, which uses an internal temperature sensor to ramp the pump up and down to maintain a constant return water temperature, and the return water temperature set point is typically set to 8°F to 10°F below the DHW tank temperature set point. In addition, after further discussion with the vendor, the AutoAdapt mode does not work well when the pumps are oversized and the pump is operating on the lower end of the pump curve. While operating in constant return water temperature mode, the average power consumption of the Model 40-80 unit was 0.025 kW with an average flow of 1.8 gpm. Figure 23 shows that the pump was ramping up and down to meet the set point for the Model 40-80 unit but was fixed at a constant speed for the Model 32-100 unit, even though it was programmed with the same control sequence. Further investigation into the issue after the demonstration was over revealed that the pump was working correctly but that there was a wiring problem between the pump and communication card that

caused the pump to not respond correctly to the constant return water temperature set point. The manufacturer has indicated this problem typically only happens for the smallest Model 32-100 pumps. The daily average electric power profile for each control mode for DHWP-1 is provided in Figure 24 and shows that the Model 40-80 pump had variations in pump power due to the constant return water temperature set point, while the 32-100 profile is flat and was not responding correctly to the programmed control sequence.

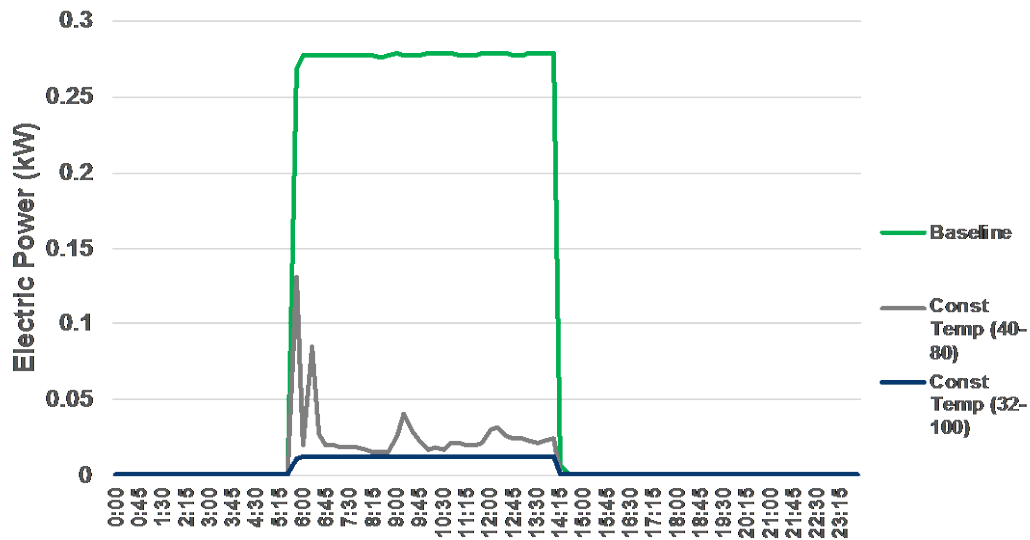

Figure 24 – DHWP-1 Daily Average Electric Power

DHWP-2

DHWP-2 followed the same sequence of control modes as DHWP-1. Power consumption of both HPCPs in the constant return water temperature control was lower compared to the baseline pump (Figure 25). The average power consumption (measured when the pump was on) of the baseline pump was 0.363 kW, while it was 0.018 kW and 0.013 kW for the constant temperature control modes, respectively (Figure 25).

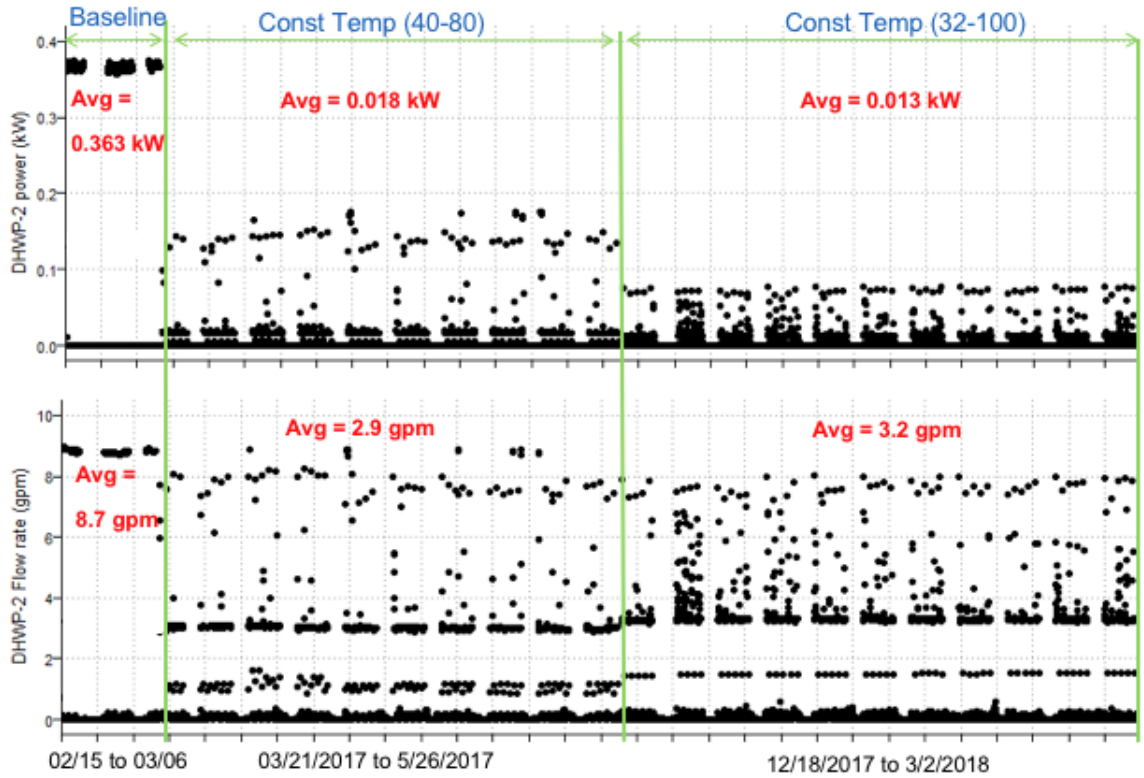

Figure 25 – DHWP-2 Power and Flow

The flow rate was reduced by ~65% in both the control modes when compared to the baseline pump, and, in this case, the new Model 32-100 pump ramped up and down correctly to meet the return water temperature set point.

The daily average electric power profile for each control mode for DHWP-2 is provided in Figure 26 and shows that both pumps were modulating to meet the constant return water temperature set point.

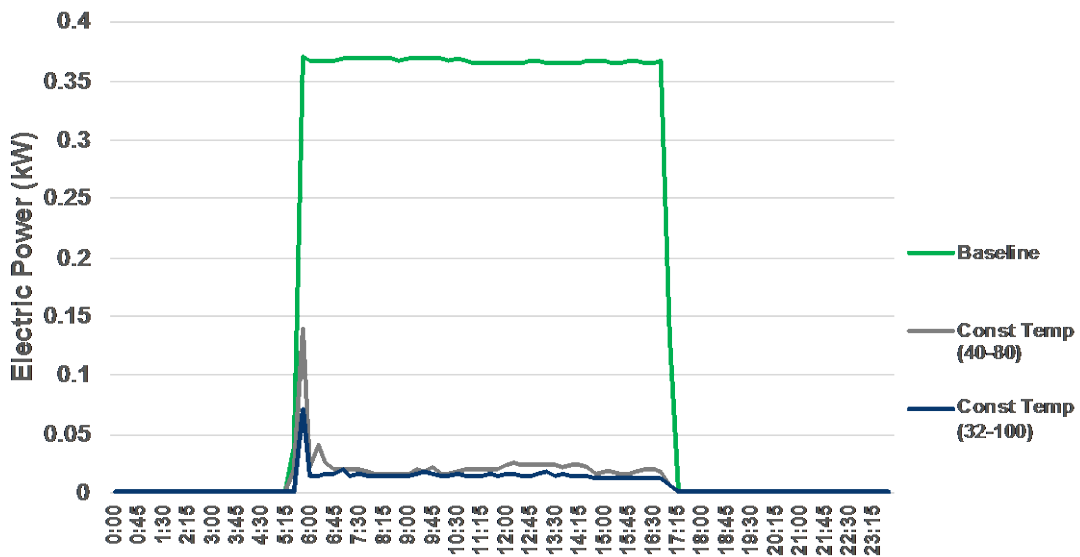

Figure 26 – DHWP-2 Daily Average Electric Power

The wire-to-water efficiency was plotted as a function of flow rate for the baseline pump and each HPCP. Figure 27 shows that the smaller Model 32-100 pump significantly improved wire-to-water efficiency above and beyond the Model 40-80 pump to a point consistent with the duty point analysis provided in Table 12 by the manufacturer.

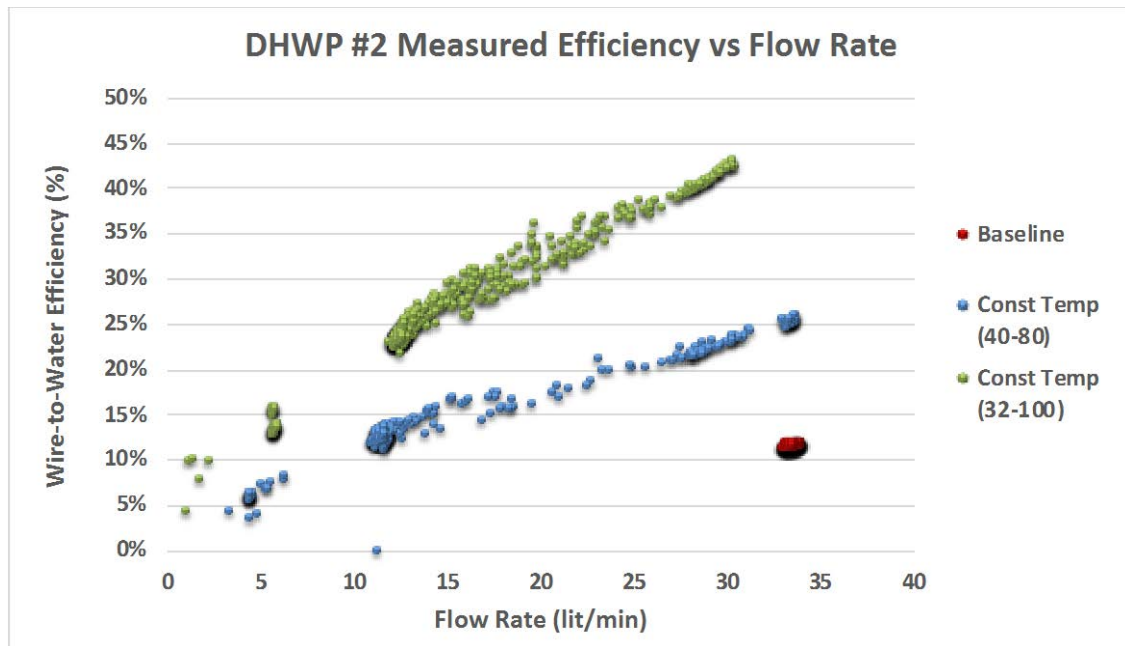

Figure 27 – DHWP-2 Wire-to-Water Efficiency vs. Flow Rate

Table 14 summarizes the measured power consumption and electricity savings for both of the DHWPs. DHWP-1 energy savings were 90% for the Model 40-80 pump and 96% for the Model 32-100 pump. DHWP-2 energy savings were 94% for the Model 40-80 pump and 96% for the Model 32-100 pump.

Table 14 – DHWP Power Consumption and Savings Estimate

DHWP Savings Estimate						
	DHWP-1			DHWP-2		
	Baseline	Constant Temp. (Model 40-80)	Constant Temp. (Model 32-100)	Baseline	Constant Temp. (Model 40-80)	Constant Temp. (Model 32-100)
Weekday Power Until Noon (kWh)	0.56	0.05	0.02	1.77	0.10	0.07
Weekday Power From Noon Until Pump is Off (kWh)	1.80	0.18	0.08	2.40	0.17	0.11
Weekday Total Power (kWh)	2.36	0.23	0.10	4.18	0.26	0.18
Max. Power (watts)	281	136	12	373	143	72
Weekday Savings	–	90%	96%		94%	96%

AHU-17 and AHU-19 Pumps

During the 2017 heating season, the two pumps were monitored in parallel, and the HPCP was originally programmed to operate in a constant differential temperature mode with a combination of the pump’s internal temperature sensor and another inline temperature sensor that is specified for use with the HPCP. The pump was not turning on correctly in this mode, and an attempt was made to increase the outside air percentage on the AHU by 20% to increase the heating load on the AHU and also reduce the temperature difference set point. It was also observed that the AHU was not meeting the DAT set point, and the decision was made to retro-commission the facility in 2018 and restart the demonstration for the 2018 cooling season. The retro-commissioning fixed the problem with the AHU not meeting the DAT set point, and the decision was made to operate the pump using a simpler 0–10-V control sequence to avoid any potential delays in the project. Although the AHU-19 pump started responding correctly to the control signal, AHU-19 serves an internal zone in the facility and retro-commissioning resulted in very little run time for AHU-19. It was primarily operating for a few hours each morning and late afternoon and then switching over to cooling mode during the day.

Because both AHU-17 and AHU-19 were small heating coil booster pumps and designed to serve a single heating coil, they are controlled to turn on/off based on a call for heating from the AHU. Figure 28 shows that AHU-17 operated almost continuously (24 hours per day, 7 days per week), while AHU-19 operated very intermittently over the demonstration period, with an average of 4.99 hours of operation per day.

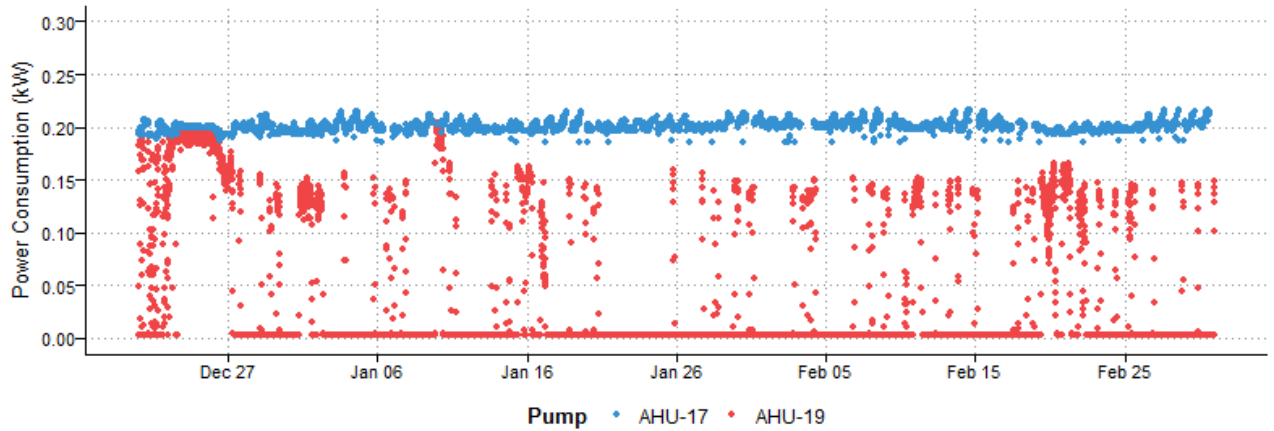

Figure 28 – AHU-17 and AHU-19 Power Consumption

A comparison between power consumption and flow for AHU-17 and AHU-19 is shown in Figure 29. As expected, power consumption and flow rate of the baseline pump (AHU-17) stayed constant, while that of the HPCP (AHU-19) varied based on the call for heat.

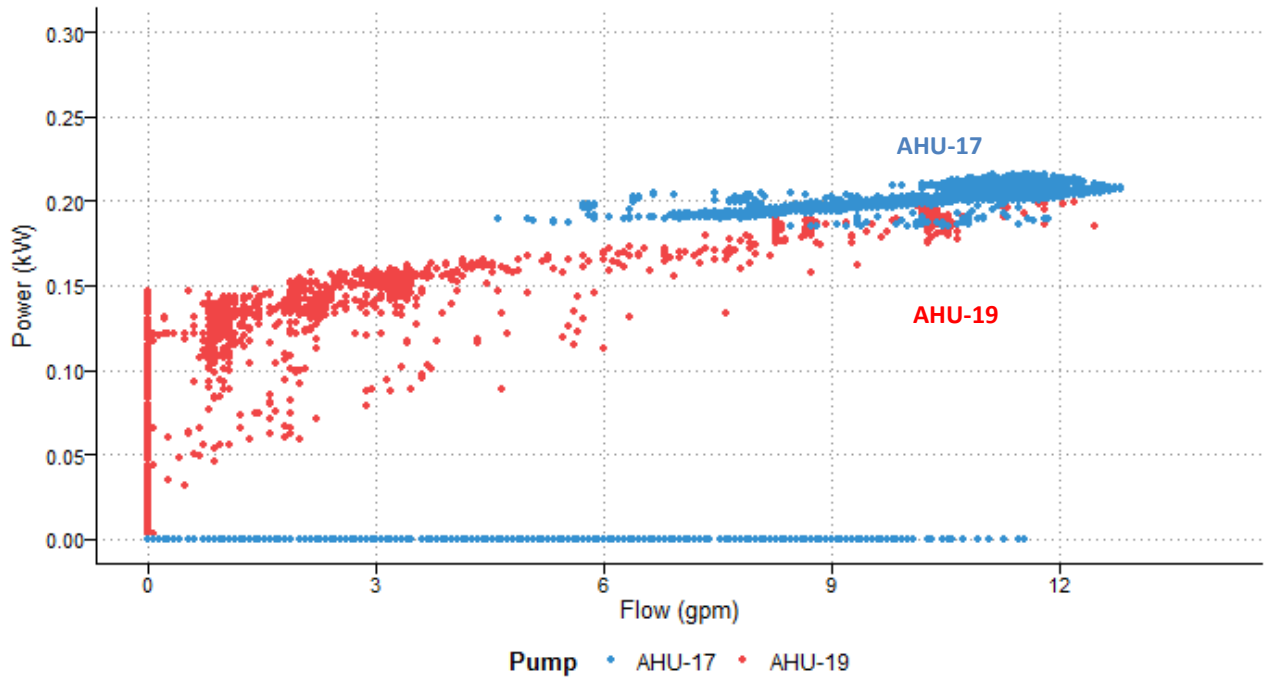

Figure 29 – AHU-17 and AHU-19 Power vs. Flow Comparison

Because AHU-17 and AHU-19 were controlled to turn on and off based on a call for heating from the BAS, the energy savings were calculated based on 1-minute data over the monitoring period. For this analysis, the constant power draw of the AHU-17 baseline pump of 221.6 watts was applied to the 1-minute data for the times that AHU-19 was operating, and the energy usage was compared over the monitoring period of December 21, 2017 to March 2, 2018. Table 15 summarizes the measured power consumption and electricity savings for AHU-19 compared with AHU-17.

Table 15 – AHU-19 Power Consumption and Savings Estimate Compared to AHU-17

	AHU-17	AHU-19
Duration	12/21/2017 to 03/02/2018	
Weekdays	45	45
Weekend Days	22	22
Max. Power (watts)	221.6	204.0
On-Peak Avg (kWh/day)	0.144	0.093
Off-Peak Avg (kWh/day)	0.728	0.550
On-Peak Savings (%)		35%
Off-Peak Savings (%)		24%

During the monitoring period, the on-peak savings were calculated to be 35% and the off-peak savings were calculated to be 24%, with an overall savings of 25.7%. The energy savings are lower for the AHUs because the reduction in peak power for the two pumps is much less than the peak power for the DHWPs. Also, because the peak power measured for AHU-19 was 204 watts versus rated peak power of 186 watts from Table 3, it is speculated that there are some inaccuracies in the dP readings for the AHU-19 pump because those dP readings came from the meters that are internal to the pump rather than using an external dP sensor that was used on AHU-17.

Power Factor Analysis

The power factor of the baseline and HPCPs was monitored to analyze any differences in power factor from the standard induction motor to an HPCP. The pre- and post-power factors for DHWP-1 are illustrated in Figure 30 and show that the average power factor for the baseline pump was around 0.5 and improved to 0.95 for the HPCP Model 40-80 and dropped to around 0.37 for the new HPCP Model 32-100.

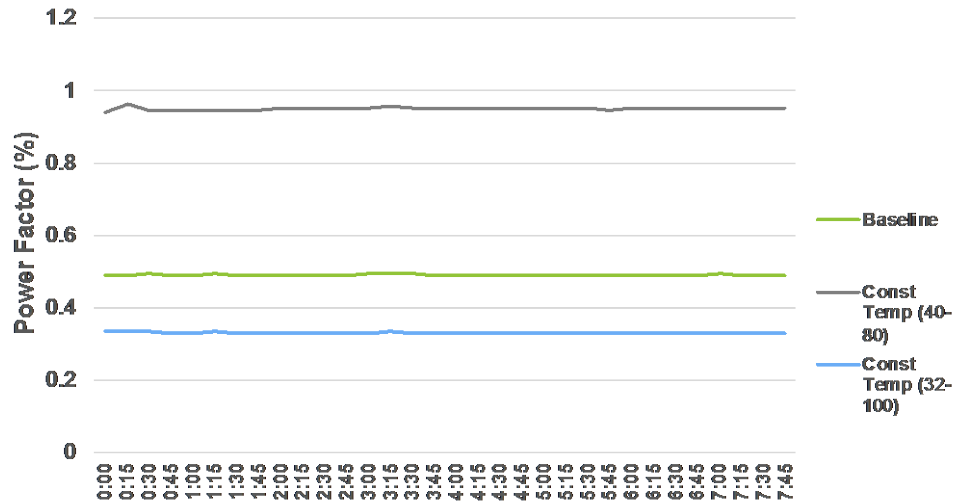

Figure 30 – DHWP-1 Daily Average Power Factor

The pre- and post-power factors for DHWP-2 are illustrated in Figure 31 and show that the average power factor for the baseline pump was around 0.65 and improved to 0.95 for the HPCP Model 40-80 and dropped to around 0.37 for the new HPCP Model 32-100 for the majority of the day, other than the initial startup where the power factor is increased.

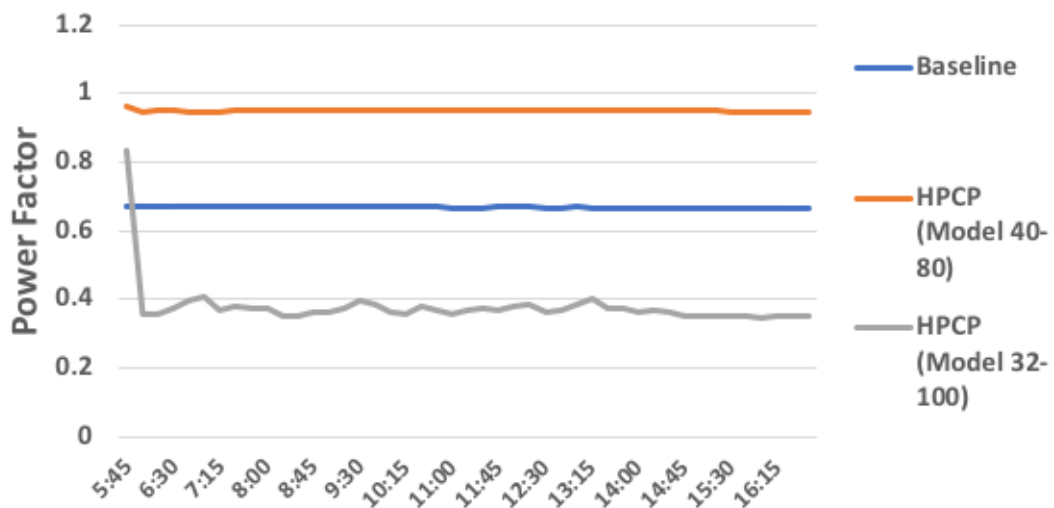

Figure 31 – Power Factor Analysis for DHWP-2

Because the new HPCP Model 32-100 that was operating on DHWP-2 was shown to ramp up and down to meet the return water temperature set point, the power factor as a function of control frequency from the HPCP was plotted and shows that the power factor increased as a function of control frequency to around 85% when the pump was running at full speed (Figure 32).

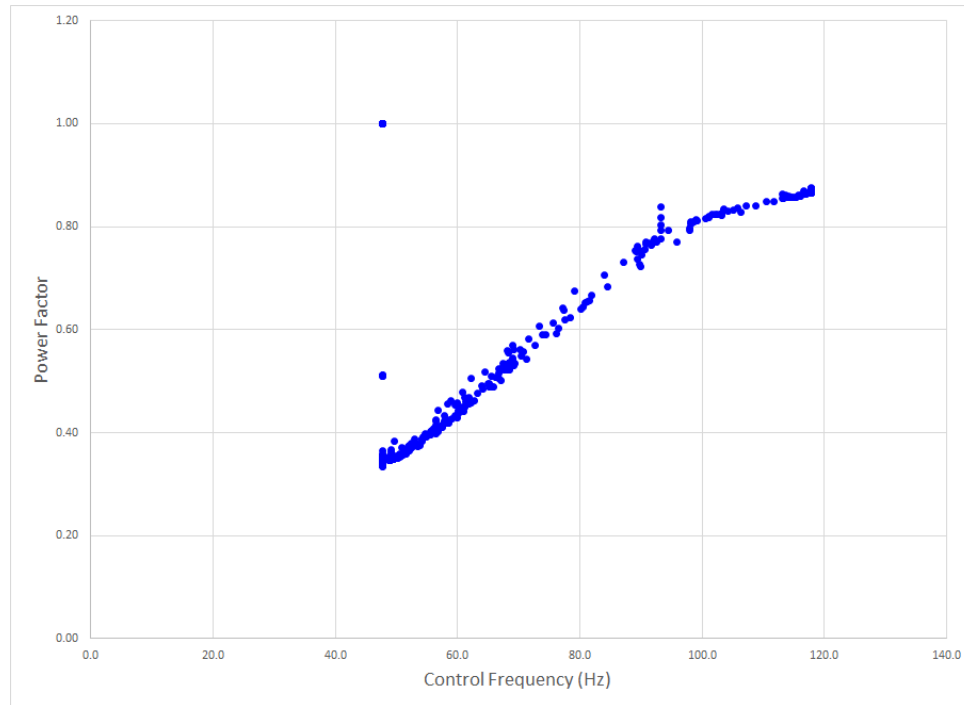

Figure 32 – Power Factor Analysis for DWHP-1

It is unclear why the smaller version of the HPCP had a lower power factor, but it is speculated that it is using a different ECM that has a lower power factor at lower loads, and the vendor was not able to provide an explanation of the lower power factor for the smaller HPCPs (Model 32-100). In addition, because smaller single-phase induction motors that were monitored as the baseline pump are not subject to the EPACT energy efficiency requirements that larger motors are subject to, these smaller motors tend to have lower power factors and lower efficiencies. The larger HPCP (Model 40-80) demonstrated significantly higher power factors and has shown the ability to improve PF for these smaller pumps. For a given motor, an electrical load with a low power factor draws more current than a load with a high power factor for the same amount of useful power. Improving power factor reduces the reactive power for a piece of equipment and the total amount of energy provided by the utility (kVA/hr.), which results in lower power factor charges and potentially lower demand charges depending on the utility’s rate structure, although because these pumps are very small, they will likely have a negligible impact on the total buildings’ power factor unless there are a lot of them in a single facility.

Objective 2: Verify Cost Effectiveness (Payback)

The cost effectiveness was evaluated based on the measured energy cost savings, retrofit/installation costs and O&M costs versus the incumbent technology. The O&M cost savings were estimated to be \$75/yr. for not having to grease bearings or replace worn out seals by onsite GSA staff for each pump. The DFC is on the Xcel Energy Transmission General, Time of Use rate structure (Table 16).

Table 16 – Xcel Energy Transmission General Rate Structure

Category	Value
Rate Name	Xcel Energy Transmission General
On-Peak Period	12–8 p.m. weekdays June 1–Sept. 30
Off-Peak Period	All other hours
Summer Season	June 1–Sept. 30 Summer demand: \$12.89/kW Summer on-peak energy: \$0.0388/kWh Summer off-peak energy: \$0.0315/kWh
Winter Season	Oct. 1–May 31 Winter demand: \$11.679/kW Winter on-peak energy: \$0.0417/kWh Winter off-peak energy: \$0.0290/kWh

Because the DFC is one of the largest campuses in Denver, it has a very low energy rate and the peak demand component of the rate makes up a large portion of the overall cost. The summer season has 87 weekdays and 35 weekend days, and the winter season has 173 weekdays and 66 weekend days for calendar year 2017.

Economic Parameters

The project lifetime for the economic analysis was set to 15 years, which is the estimated lifetime of the pump. The fiscal year 2017 federal discount rate, implied long-term inflation rate and real electricity escalation rate for Colorado are provided in Table 17 (NIST 2018).

Table 17 – Economic Parameters

Category	Value
Project Lifetime	15 years
Federal Real Discount Rate (excluding general price inflation)	3.00%
Federal Implied Long-Term Average Inflation Rate	-0.40%
National Institute of Standards and Technology (NIST) Real Electricity Escalation Rate for Colorado	-0.32%

Installed Costs

The installed costs for the HPCPs were estimated based on the cost data from a local distributor [TM Sales (<http://www.tmsalesinc.com>)] that sells the HPCP as well as market standard pumps. The labor estimates were provided by the DFC staff based on their experience installing the DHW and HHW pumps. The capital costs for the pump and flange set were included in the capital cost estimate. Capital costs for the BACNet card and the cost of integrating the pump with the BAS were not included in the capital cost, since the controls internal to pump were used in this demonstration and just the existing BAS on/off controls were utilized. The economic analysis was conducted assuming the baseline pump was at the end of its useful life, and the delta between the HPCP cost and a standard replacement pump cost was used to calculate the incremental installed cost. The estimated installed cost of the stainless-steel version of the HPCP for DHW applications is provided in Table 18 (stainless steel pumps are required for all potable water/DHW applications).

Table 18 – HPCP Model 40-80 Installed Cost Estimate for DHW Application

Item	Per Unit Cost (\$)	Quantity	Total Cost (\$)
HPCP Model 40-80F V 115: Stainless Steel and Flange Set	\$2,030	1.00	\$2,030
Labor Cost	\$75	5.00	\$375
Total Cost per DHWP	-	-	\$2,405

The labor time for the HPCP is estimated to be 2 hours greater than a standard pump due to the need to set the program on the pump and make sure the program is working correctly. The estimated installed cost of a market standard pump for the DHWP-1 application is provided in Table 19.

Table 19 – Market Standard ½ HP DHWP Installed Cost Estimate

Item	Per Unit Cost (\$)	Quantity	Total Cost (\$)
Market Standard ½ HP DHWP and Flange Set	\$1,351	1.00	\$1,351
Labor Cost	\$75	3.00	\$225
Total Cost per DHWP			\$1,576

The HPCP Model 40-80 was estimated to cost \$829 more to install than the market standard DHWP. The estimated installed cost of the smaller HPCP Model 32-100 for the DHW application is provided in Table 20.

Table 20 – HPCP Model 32-100 Installed Cost Estimate for DHW Application

Item	Per Unit Cost (\$)	Quantity	Total Cost (\$)
Grundfos Magna3 32-100: Stainless Steel and Flange Set	\$850	1.00	\$850
Labor Cost	\$75	5.00	\$375
Total Cost per DHWP	-	-	\$1,225

The estimated installed cost of the smaller market standard pump, which is ¼ HP and similar in size to the HPCP Model 32-100, is provided in Table 21.

Table 21 – Market Standard ¼ HP DHWP Installed Cost Estimate

Item	Per Unit Cost (\$)	Quantity	Total Cost (\$)
Market Standard ¼ HP DHWP and Flange Set	\$425	1.00	\$425
Labor Cost	\$75	3.00	\$225
Total Cost per DHWP	-	-	\$650

In this case, the installed cost difference between the HPCP Model 32-100 and smaller market standard ¼ HP pump is \$575.

DHWP Energy Savings and Economics

The energy savings and economics for the two DHWPs in Constant Temperature mode are provided in Table 22. For the two DHWPs, the effective blended electric rate ranged from \$0.077/kWh to \$0.099/kWh, with the higher rate being associated with DHWP-1 when the pumps were not ramping up to meet the return water temperature correctly, which resulted in higher demand savings for those cases.

Table 22 – DHW Energy Savings and Economics

Category	DHWP-1 - Constant Temp. (Model 40-80)	DHWP-1 - Constant Temp. (Model 32-100)	DHWP-2 - Constant Temp. (Model 40-80)	DHWP-2 - Constant Temp. (Model 32-100)
Annual Energy Savings (kWh/yr.)	554	587	1,017	1,039
Annual Energy Cost Savings (\$)	\$18	\$19	\$35	\$36
Peak Demand Reduction (kW)	0.15	0.27	0.23	0.30
Annual Demand Cost Savings (\$)	\$21	\$39	\$33	\$44
Total Annual Cost Savings (\$)	\$39	\$58.0	\$68.5	\$79.5
Annual O&M Cost Savings (\$)	\$75	\$75	\$75	\$75
Installed Cost (\$) (HPCP installed cost—standard pump installed cost)	\$829	\$575	\$829	\$575
Simple Payback	7.3	4.3	5.8	3.7
Net Present Value (\$)	\$512	\$988	\$857	\$1,240
Savings-to-Investment Ratio	1.6	2.7	2.0	3.1

Because the baseline flow rate for DHWP-2 was roughly twice that of DHWP-1, and because DHWP-2 was a ½ HP pump and DHWP-1 was a ¼ HP pump, the energy savings and economics are better for DHWP-2. For both cases, the smaller HPCP had a simple payback of less than 5 years and a SIR >1.

AHU-19 Energy Savings and Economics

The estimated installed cost of the HPCP for AHU-19 is provided in Table 23.

Table 23 – HPCP Installed Cost Estimate for AHU-19 Application

Item	Per Unit Cost (\$)	Quantity	Total Cost (\$)
HPCP Model 40-80, 230-V Cast Iron and Flange Set	\$1,330	1.00	\$1,330
Labor Cost	\$75	5.00	\$375
Total Cost for AHU-19 Pump	-	-	\$1,705

The estimated installed cost of a market standard pump for the AHU-17 application is provided in Table 24.

Table 24 – Standard Pump Installed Cost Estimate for AHU-17 Application

Item	Per Unit Cost (\$)	Quantity	Total Cost (\$)
Market Standard DHWP and Flange Set	\$980	1.00	\$980
Labor Cost	\$75	3.00	\$225
Total Cost per DHWP			\$1,205

Based on the provided installed cost estimates, the installed costs for the cast iron HPCP are estimated to be \$500 more than the market standard baseline pump.

The annual energy use and cost of AHU-17 versus AHU-19 is provided in Table 25.

Table 25 – AHU-17 and AHU-19 Energy Use and Cost

Category	AHU-17 Energy Use and Cost	AHU-19 Energy Use and Cost
Annual Energy Usage (kWh/yr.)	173	128
Annual Energy Cost (\$)	\$5	\$4
Peak Demand (kW)	0.2216	0.204
Annual Demand Cost (\$)	\$21	\$19
Total Annual Cost (\$)	\$26	\$23
Annual O&M Cost (\$)	\$75	\$0
Installed Cost (\$)	\$1,205	\$1,705

The annual energy savings and economics for AHU-19 is provided in Table 26. For the first case of AHU-19 Model 40-80, the effective blended electric rate was \$0.068/kWh

Table 26 – AHU-19 Energy Savings and Economics

Category	AHU-19 Model 40-80	AHU-19 (with 60% save, 20 hrs./day)	AHU-19 Savings (with 60% save, 20 hrs./day, 11 cent rate)
Annual Energy Savings (kWh/yr.)	45	688	688
Annual Energy Cost Savings (\$)	\$1	\$23	\$76
Demand Reduction (kW)	0.0176	0.08	0.08
Demand Cost Savings (\$)	\$2	\$18	\$0
Total Annual Cost Savings (\$)	\$3	\$41	\$76
Annual O&M Cost Savings (\$)	\$75	\$75	\$75
Installed Cost (\$)	\$500	\$500	\$500
Simple Payback	6.4	4.3	3.3
Net Present Value (\$)	\$420	\$865	\$1,274
Savings-to-Investment Ratio	1.8	2.7	3.5

A second case was created (AHU-19 with 60% save, 20 hrs./day) where the baseline pump was assumed to operate at 330 watts and the new HPCP had an average power draw of 132 watts, which operated on a schedule that was similar to AHU-17 at 20 hours per day to try to replicate a more typical heating system retrofit with an older market standard pump. In this case, the savings go up to 688 kWh/yr., which is in line with the savings from DHWP-1, and, when the average GSA electric rate of 11 cents/kWh is applied, the simple payback drops to 3.32 years. The economic analysis indicates the annual O&M cost savings of \$75/yr. has a very large impact on the economics and that the simple payback is sensitive to the percent energy savings, the run time of the pump and the local electric rate.

Energy Savings Sensitivity Analysis

For the two DHWPs, the effective blended electric rate ranged from \$0.077/kWh to \$0.099/kWh, with the higher rate being associated with DHWP-1 when the pumps were not ramping up to meet the return water temperature correctly, which resulted in higher demand savings for those cases. An effective blended rate is calculated based on the peak demand cost savings plus the energy cost savings divided by the total energy savings in kilowatt-hours. Because the effective blended rate for this site was lower than other GSA sites throughout the country, a sensitivity analysis was conducted on electric rates to see what the payback would be for higher electric rates. The sensitivity was run at \$0.06/kWh, \$0.08/kWh, \$0.1/kWh, \$0.12/kWh, \$0.14/kWh, \$0.16/kWh, \$0.18/kWh, \$0.2/kWh and \$0.22/kWh. For

the sensitivity analysis, the installed cost was calculated assuming an end-of-life pump replacement because of the incremental installed cost difference between an HPCP and standard stainless steel DHWP and the annual O&M cost savings was \$75/yr.

For AHU-19, the effective blended electric rate was \$0.068/kWh, and an electric rate sensitivity analysis was applied to the AHU-19 savings case with 60% savings and 4,160 hours of operation per year [or operating 47% of the time throughout the year, assuming an end-of-life incremental installed cost of \$500/pump (Figure 33)].

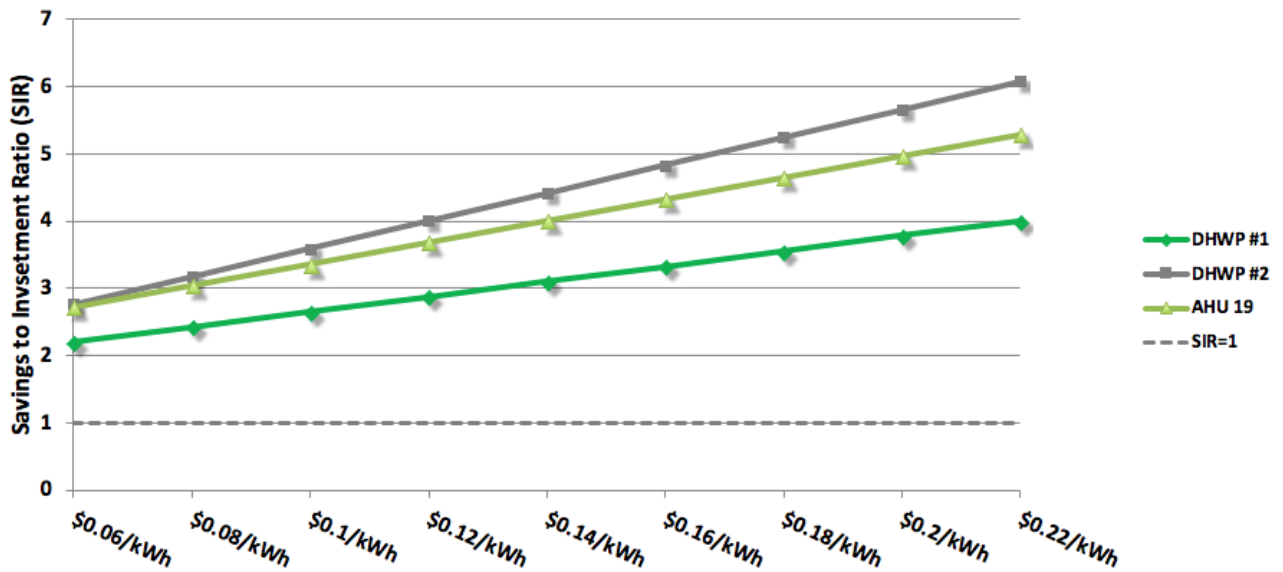

Figure 33 – DHWP-1/DHWP-2 and AHU-19 Electric Rate Sensitivity Analysis

The sensitivity analysis for both DHWPs and AHU-19 indicates that the SIR is greater than 1 across all cases, all of the way down to a blended electric rate of \$0.06/kWh when the O&M cost savings of \$75/yr. is added to the annual energy cost savings. It should be noted that given the significant energy savings of more than 90% for both DHWPs, the SIR would be lower if the energy savings ranged from 50% to 70%.

It should also be noted that if the smaller circulator pump was to be replaced with a standard pump with an induction motor and a variable frequency drive (VFD), the installed costs would be approximately \$6,125. This includes a pump cost of \$1,200, purchase and installation of the VFD of \$2,600, miscellaneous plumbing parts cost of \$100, costs to tie into the BAS of \$2,000 and labor costs to install the pump of \$225. In this case, the HPCP would have very significant installed costs savings, regardless of energy savings for a given application. Although VFDs can be applied to smaller pumps, they are typically not installed on smaller pumps less than 2 HP.

Objective 3: Air Handling Coil Can Meet DAT Set Point and DHWP Can Meet the Return Water Temperature Set Point

AHU DAT Analysis

The DAT was analyzed for AHU-19 over the monitoring period of December 21, 2017 to March 2, 2018. Figure 34 shows the DAT set point and measured DAT from 6:45 a.m. to 9:15 a.m. when the pump was operating on December 21, 2017.

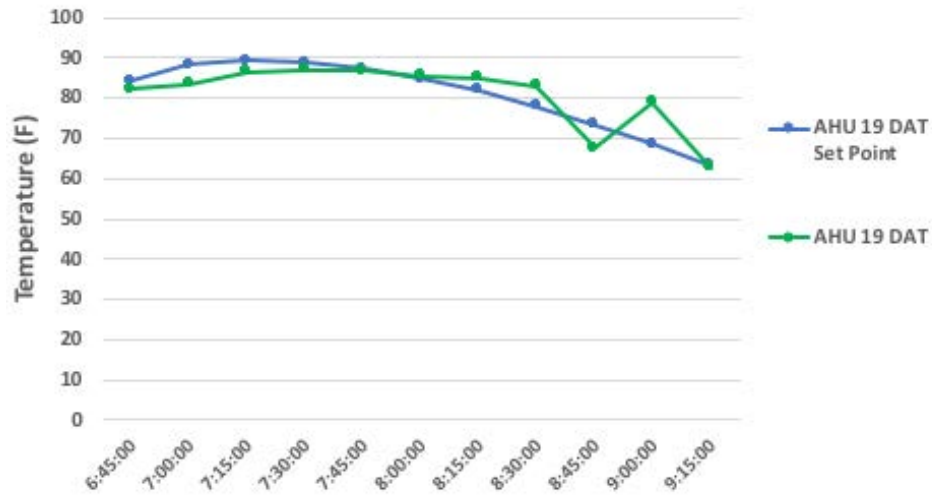

Figure 34 – AHU-19 Supply Air Temperature Analysis (December 21, 2017)

Figure 34 shows that the DAT was able to meet the DAT set point, but the pump is only operating for a few hours in the morning to bring the space up to temperature, and the discharge temperature set point starts dropping as the space heats up during this period.

DHW Return Water Temperature Analysis

The DHW return water temperature was analyzed to ensure the HPCPs were still maintaining the required return water temperature set point. The return water temperature for DHWP-1 and DHWP-2 (only when the pumps are running) is shown in Figure 35.

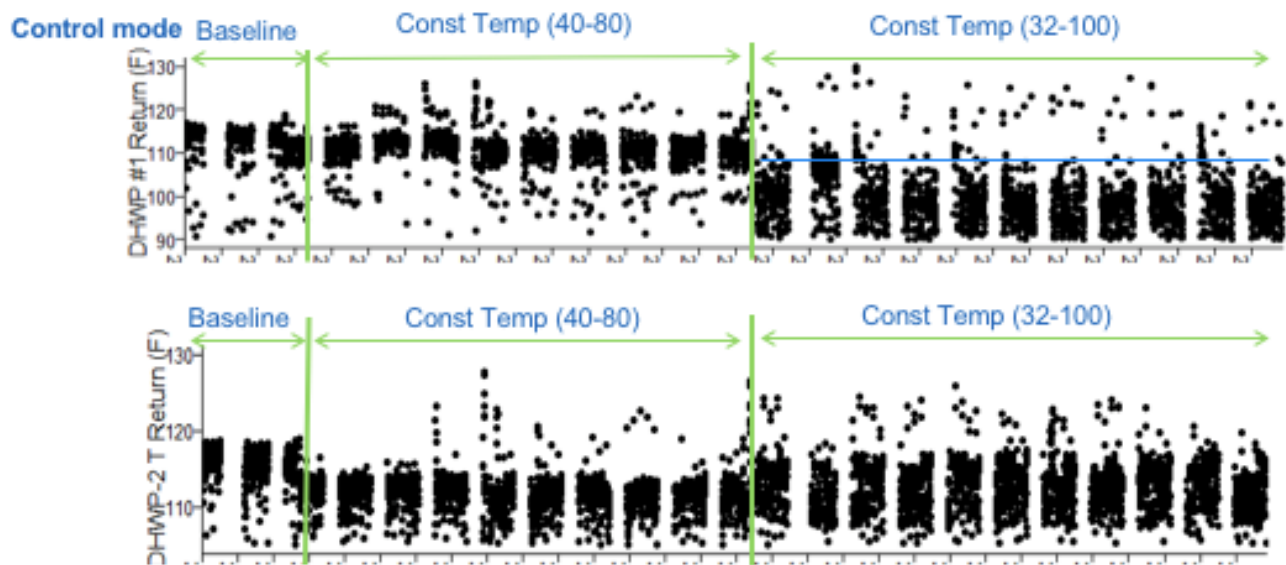

Figure 35 – DHWP-1 and DHWP-2 Return Water Temperature

The average return water temperature (measured when the pump was on) remained consistent with the baseline for DHWP-1 for HPCP Model 40-80 but dropped off for the HPCP Model 32-100 and was not meeting the return water temperature set point in this case. The return water temperature dropped

slightly for DHWP-2 when the HPCP Model 40-80 was installed, but it was still meeting the set point and also met the set point for the smaller Model 32-100 unit.

B. QUALITATIVE RESULTS

Objective 4: Evaluate Ease of Installation and Operability

The technicians who installed the pump estimated that it would take around 5 hours of labor to remove the old pump and install a new HPCP. The same technicians estimated 3 hours to remove and install a standard pump, with the increased time requirements coming from the need to program the new HPCP. The NREL team installed additional measurement and verification (M&V) equipment, including temperature sensors, pressure transducers and flow meters that all took additional time that would not be needed in a standard installation. The installation at the DFC also included external temperature sensors that were integrated into the HPCP, but these sensors would only be needed if a site is interested in operating the HPCPs in differential temperature mode and would not be needed in all applications. For the constant return water temperature mode used for the DHW recirculation loop, the temperature sensor that is used in the software program is internal to the pump and does not require a second external temperature sensor.

Operability was evaluated by interviewing the onsite O&M staff. The criteria for success are that it should not introduce a steep learning curve and should not impact the regular O&M effort. The O&M staff did not report any steep learning curve with the pump. In general, the DHWP installation was very straightforward, and there were no issues with programming the HPCP Model 40-80 pumps. For the new, smaller HPCPs, the following issues were encountered during the demonstration:

- *DHWP installed in wrong direction:* Due to the DHW lines not being labeled, the DHWPs were installed in the wrong direction and were corrected. This is not an issue regarding the pumps but relates to the piping system on which the pumps were installed.
- *DHWP failure:* One of the new DHWPs (HPCP Model 32-100) failed due to a wiring issue on the control board (that was internal to the pump) and needed to be replaced.
- *DHWP responding to control mode:* As noted above, both Model 40-80 HPCPs responded to the constant return water temperature control mode correctly, but one of the smaller Model 32-100 pumps did not; thus, one of the four DHWPs that were installed did not respond correctly to the programmed control mode. Further investigation into the issue after the demonstration period revealed that the pump was working correctly, but there was a wiring problem between the pump and communication card.

For Building 810, there were several issues encountered throughout the project and a number of other installation and operability issues that had to be addressed during the demonstration.

- *AHU-19 control mode programming:* The HPCP was originally programmed to operate in a differential temperature mode during the 2017 heating season that monitored supply and return water temperature through the AHU heating coil. The temperature differential was set to differing values, 30°F, 20°F and 10°F, but the pump never responded correctly in this control mode. As a next step, the pump was programmed based on a simple 0–10-V control from the BAS to ramp the pump up and down to meet the DAT set point, and although the pump started ramping up and down, as noted above, it was not meeting DAT. Both of these problems are suspected to be caused by ongoing retro-commissioning problems. Due to some of the external complications with the heating,

ventilation and air conditioning system in this building, the pumps were not evaluated in other control modes offered by the vendor.

- *Integration into BAS:* GSA provided funding to Siemens to integrate the pumps into the BAS, but, due to the tight timeline of this project, GSA was not able to get the pumps integrated into the BAS in time, and the BAS integration was put on hold until the end of the GPG project, at which time the pumps will be connected to the BAS. Under the current system, the existing pump on/off status is the only BAS point for the pumps, and the HPCPs are set to different control modes using the controls that are internal to the pump. For this demonstration, NREL installed Modbus communication cards and read data from the HPCPs directly to the NREL data loggers as opposed to installing BACnet cards and integrating the pumps with the BAS.
- *HPCP smart phone application:* The HPCPs have a smart-phone-based application that can be used to monitor the operation of the pumps and read out data from the pumps. GSA and NREL met with the GSA information technology (IT) group and decided not to connect the pumps to the local Wi-Fi network and not evaluate this capability due to IT security concerns that would delay the installation of the pumps.

IV. Summary Findings and Conclusions

A. OVERALL TECHNOLOGY ASSESSMENT AT DEMONSTRATION FACILITY

Overall, the HPCP technology has demonstrated the potential to save over 90% of electrical energy in both DHW applications. The HPCPs installed in DHW applications were able to run at a lower flow rate and head, while maintaining the return water temperature set point for three of the four pumps that were tested. They are smaller in size, with higher wire-to-water efficiencies, and the payback period was found to be less than 5 years for both smaller HPCPs.

Energy savings were shown to vary significantly based on flow rate, differential pressure and run time for the same model pump installed in different applications at the DFC. The same model pump was installed in all three applications, and the annual energy savings for the DHWPs was significantly higher due to the longer run times and increased savings at full load power. Figure 36 shows that DHWP-2 had the greatest savings, followed by DHWP-1, with AHU-19 savings being very low compared to these two cases. The AHU-19 DHWP-2 is shown to have savings slightly higher than DHWP-1, but the energy savings for these pumps could be substantially higher than those listed here in applications with higher flow rates. As in all cases, the pumps that were installed (HPCP Models 32-100 and 40-80) could handle much higher flow rates.

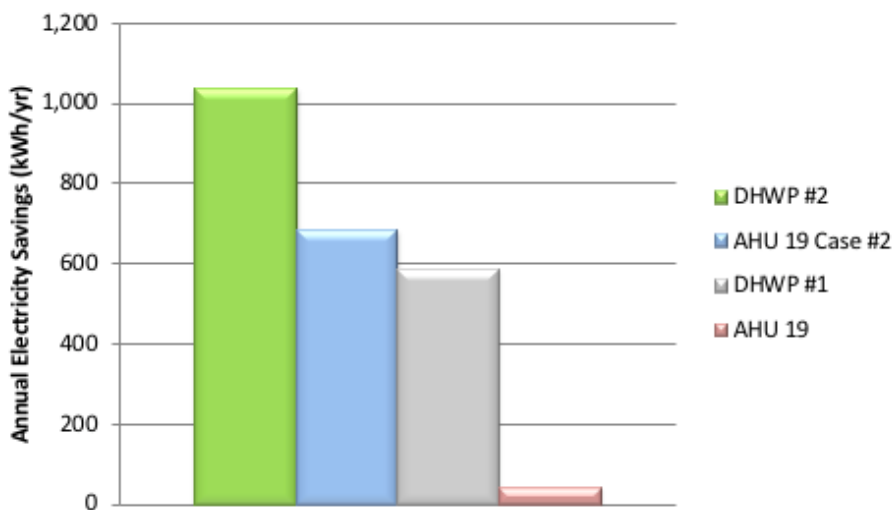

Figure 36 – Annual Energy Savings Comparison Across Pumps

The annual O&M cost savings of \$75/yr. was found to have the biggest impact on the life cycle cost effectiveness of the HPCPs, and all systems were shown to have an SIR >1 with electric rates of \$0.06/kWh to \$0.22/kWh or higher.

B. LESSONS LEARNED AND BEST PRACTICES

The study provided some valuable insights into the operation of the pump and its interaction with the system as a whole. Some of the lessons learned and best practices are summarized next.

- *Three-way bypass valve needs to be converted to a two-way valve*

The HPCP was not modulating initially when installed on AHU-19. The three-way valve was not able to shut off the bypass leg when there was no call for heat. A ball valve had to be installed on the bypass leg to shut it off. For future installations, the best option is to install a two-way control valve and remove the bypass leg altogether, but, in either case, the flow through the bypass loop must be closed for these systems to operate correctly. It is suspected that a pressure independent two-way valve would also result in improved performance over the current configuration at AHU-19.

- *Correctly size the pump for the application*

For these smaller pumps, most engineers apply a safety factor to slightly oversize pumps. The pump-sizing methodology should be analyzed when installing a new pump technology. Although the HPCPs installed for the DHWP applications had more than 90% energy savings, the pumps operated with a very low flow and differential pressure and, consequently, operated at a low wire-to-water efficiency point. As noted in Figure 27, the wire-to-water efficiency improved significantly with the smaller HPCP when the pumps were sized correctly.

Because smaller pumps on the order of ½ to 1 HP do not have differential pressure ports that can be used to estimate flow and head from a pump curve, the following procedure was recommended by the manufacturer to help correctly size the pumps in future applications:

1. Determine the pipe sizes and lengths and calculate the actual head loss from the pipes. That will provide a means of estimating the flow and head required for an HPCP.
2. Observe supply and return temperature differential to make an educated guess about the existing pump's suitability for that system. For example, if the Delta-T is extremely small (2–5°F), the pump is likely oversized.
3. If the building engineer can identify the existing pump's curve, horsepower and measured pump power (watts) and match a new pump to the old pump's curve based on pump power, the engineer can sometimes use the pump power to identify if the pump is oversized and install a right-sized pump.

- *Integrate the building automation system and smart phone apps*

Integrating the pumps into the BAS can more than double the installed costs of the pumps because they are small pumps and, in general, this additional cost is not warranted as it is not anticipated to result in additional energy savings. For the pumps demonstrated, there are a lot of points that could be potentially added to the BAS given all of the internal control modes and monitoring points inside the pump. Each control point is estimated to cost \$1,000–\$1,500 per point. GSA sites are encouraged to use the existing on/off status BAS points and use the pre-programmed control modes on the pump. If the smart phone app can comply with IT security requirements, pump analytic data could be provided directly through the app.

- *Constant temperature control mode is preferable for DHW applications*

For future installations, sites are encouraged to use the constant temperature control mode for DHW applications.

- *Control mode recommendation for heating systems*

For future installations, the site is encouraged to use one of the control modes internal to the pump, based on the manufacturer's recommendations, or use a simple 0–10-V signal from the BAS.

- *Ensure the BAS system is operating correctly before installing the pump*

As noted throughout the report, ongoing retro-commissioning items related to overall building operation caused the biggest issues, and the building staff need to make sure these issues are all resolved before installing an HPCP. If there are ongoing retro-commissioning problems and an HPCP is installed, it will not operate correctly and cause confusion for onsite staff as to the source of the control problems.

C. DEPLOYMENT RECOMMENDATIONS

The HPCP has demonstrated the ability to reduce energy usage significantly in small circulator pumping systems and should be considered for the following applications in GSA facilities:

- *DHW recirculation pumps:* DHWP recirculation system installations resulted in the greatest percent energy savings and had very straightforward control system integration. DHW recirculation pumps at other GSA sites are also anticipated to have very irregular loads due to the intermittent schedule of hand washing and dishwashing and could result in significant energy savings. Future deployments should focus on utilizing the constant return water temperature control mode with the HPCP's internal temperature sensor. With the use of the smaller HPCP (less than 2.5 HP), the economics are favorable for end-of-life replacement with as little as 40 hours/week of pump operation at the low electric rates in Denver, Colorado.
- *Small heating system pumps:* Small heating system application economics are going to be impacted by the length of the heating season at the site, hours of operation per day and local utility rates. Sites with older constant volume pumps with standard induction motors less than 2.5 HP that operate for more than 8–12 hours per day, 8 months per year, with electric rates of 6 cents/kWh or higher should be targeted. Small heating pumps that serve multiple heating coils are anticipated to have greater energy savings due to more intermittent operation, longer run times and increased flow rate requirements. For small heating systems, all three-way control valves should be converted to two-way valves.
- *Small chilled water system pumps:* Chilled water pumping system applications should be considered for future deployments, and the same system characteristics that are required for a cost-effective HHW installation would also apply to small chilled water pumping system applications.
- *Solar hot water systems:* Solar hot water (SHW) system applications should be considered for future deployments. SHW systems are typically operational throughout the year and would have operational hours similar to the two DHWP applications that were tested. In this case, the site would need to work with the SHW installer to determine the appropriate control mode and estimate energy savings and economics.
- *Small geothermal heat pump applications:* Small geothermal heat pump (SGHP) applications have an advantage over separate heating and cooling applications because they typically operate all year long to provide heating and cooling to a facility and should be considered for future deployments. The site will need to confirm with the SGHP vendor that a variable flow HPCP is compatible with the given system and could be applied to either the ground loop pump or building pumps. If an HPCP is applied to the building loop pumps, there is potential that a larger number of three-way control valves will need to be converted to two-way control valves. Deployment for end-of-life replacement with greater than 40–60 hours/week with electric rates of \$0.06/kWh or higher is recommended.

V. Appendices

A. CONTROL MODES

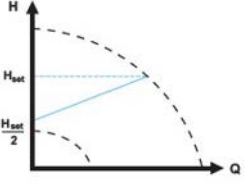
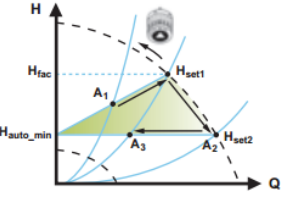
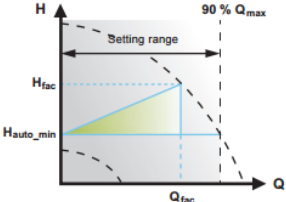
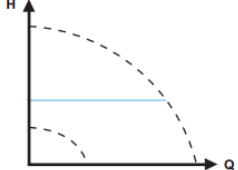
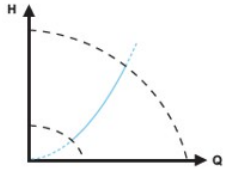
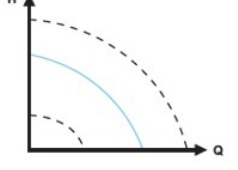
Control Mode	Description	Pump Curve (Source: Grundfos n.d.)
Proportional pressure	Recommended for applications with large pressure losses in the distribution pipes. Head of the pump increases proportionally to the flow to compensate for pressure losses.	
AutoAdapt	<p>Recommended for heating system. Pump auto-adjusts the control curve with varying flow and head</p> <p>A₁: Original duty point A₂: Lower registered head on the max. curve A₃: New duty point after AUTO_{ADAPT} control H_{set1}: Original set point setting H_{set2}: New set point after AUTO_{ADAPT} control H_{fac}: Factory setting H_{auto_min}: A fixed value of 1.5 m.</p>	
FlowAdapt	FlowAdapt control model operates the pump in AUTO _{ADAPT} control mode and limits the flow to a selected FLOW _{LIMIT} value.	
Constant pressure	Recommended in systems with small pressure loss. Pump head is constant, independent of the flow.	
Constant temperature	Pump controlled to maintain constant return water temperature. External temperature sensor must be installed in the return line. Ideal application for DHW systems.	
Constant curve	With the help of an external controller, pump can switch from one constant curve to another, depending on the value of the external signal. Pump can also operate following a max. or min. curve, similar to an uncontrolled pump.	

B. REFERENCES

Grundfos. n.d. “Grundfos MAGNA3 Datasheet.” Accessed August 6, 2018.

<https://us.grundfos.com/products/find-product/magna3.html>.

GSA. 2017a. “DFC Building 810.” Last reviewed August 13, 2017.

<http://www.gsa.gov/portal/content/102192>.

GSA. 2017b. “DFC Building 67.” Last reviewed August 13, 2017.

<http://www.gsa.gov/portal/content/102160>.

Hydraulic Institute, Europump, and U.S. Department of Energy. 2004. *Variable Speed Pumping: A Guide to Successful Applications*. May 2004, DOE/GO-102004-1913,

https://www1.eere.energy.gov/manufacturing/tech_assistance/pdfs/variable_speed_pumping.pdf.

Morrison, Jessica and Stephen Putnam. 2016. “High Performance Circulator Pumps (Energy Management Information Systems).” Presented by Grundfos Pumps Corp. to GSA’s Green Proving Ground Program and DOE, FY2016.

NIST. 2018. *Energy Price Indices and Discount Factors for Life-Cycle Cost Analysis – 2017: Annual Supplement to NIST Handbook 135*. National Institute of Standards and Technology. April 2018, NISTIR 85-3273-32. <http://nvlpubs.nist.gov/nistpubs/ir/2018/NIST.IR.85-3273-33.pdf>.

Samotyj, M. 2013. “Assessment of New Motor Technologies and their Applications: Evaluation of an Advanced Circulator Pump for Residential, Commercial and Industrial Applications.” *Electric Power Research Institute (EPRI)*, December 4, 2013.

<https://www.epri.com/#/pages/product/000000003002001762/>.

C. GLOSSARY

Circulator Pump	Smaller constant speed pumps that typically have the motor rotor, pump impeller and support bearings combined and sealed within the water circuit. These pumps are typically either constant speed or have multiple speed settings and are used in DHW, HHW and chilled water (CW) applications up to 5 HP.
Domestic Hot Water	Systems that provide hot water to bathroom sinks, kitchen sinks, showers and kitchens, for example, throughout the facility. Hot water is typically supplied at around 120°F.
Heating Hot Water System	In commercial buildings, heating hot water systems typically consist of an onsite boiler plant that heats water to 180°F and supplies it to AHUs, variable air volume (VAV) boxes, fan coil units and radiant heating systems, for example, to provide heating for the facility. There are typically larger pumps at the boiler and, in some cases, smaller booster pumps for AHUs and radiant coils.

D. MANUFACTURER CUT SHEET

Manufacturer data sheets are provided in Figure 37 to Figure 39 (Grundfos n.d.).

MORE THAN A PUMP

IF YOU ARE LOOKING FOR THE BEST EFFICIENCY ON THE MARKET COMBINED WITH HIGH INTELLIGENCE AND TRULY FULL RANGE, LOOK NO FURTHER. THE MAGNA3 IS HERE

Reliable innovation

The MAGNA3 is a circulator pump based on the tried and tested MAGNA technology and our industry-leading experience with electronic pumps. The permanent magnet motor, AUTODiAPr function and integrated frequency converter is still part of the MAGNA package, but we've added some additional, ground-breaking new technologies. The result is a cutting-edge piece of intelligent technology that retains the unrivalled Grundfos reliability.

FULL RANGE

– perfect fit and low life cycle costs

BEST EFFICIENCY IN THE MARKET

– minimize energy costs

HIGH INTELLIGENCE

– reduce investment costs and gain complete control of your system

PROVEN RELIABILITY

– based on 40 years of experience and 1 million test hours

EASY INSTALLATION

– save time and effort

THE HIGHEST STANDARDS, THE GREATEST RESULTS

Ready for range?

MACNA3 is a truly full-range pump with more than 25 different single and twin circulators in cast iron or stainless steel. We have also increased the maximum head to 60 Ft and the flow to 550 GPM. Get ready to specify a perfectly sized circulator pump for any HVAC AUTODiAPr application.

The smart pump

MACNA3 gives you new opportunities with more intelligent control modes, optimized building management communication and a built-in heat energy meter. It also allows you to save pump throttling valves in the system. It is fair to say that we have raised the bar for intelligent pumping.

Efficiently the best

The short version is this: MACNA3 is the most efficient circulator available on the market today. The longer version is this: With the lowest Efficiency Index (EI) in the world, below 0.20, you can achieve energy savings of up to 75% compared to a typical installed circulator. With the unique Autodist control these savings can be as much as 85% and thereby a remarkably fast return on investment.

Reliable from A to Z

At Grundfos we do not take testing lightly. With 40 years of experience with electronically controlled pumps and 1 million test hours for the MACNA3 in extreme conditions, including alternating pressure tests, high humidity tests as well as high and low-temperature tests, we are confident that this pump will serve you day in and day out for many years to come.

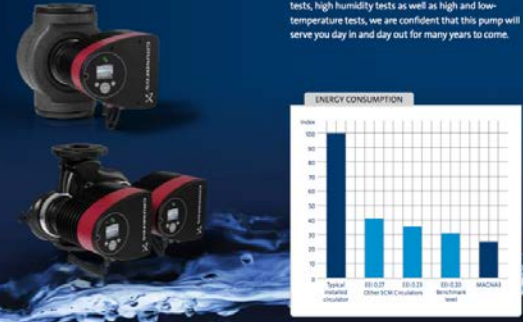

FULL-RANGE EFFICIENCY

Full range means perfect fit

The extended MAGNA3 range with maximum heads of 60ft and maximum flows of 550 GPM features more than 25 single and twin pumps in cast iron or stainless steel. This means that it is much easier to right-size the MAGNA3 for any duty point and cut both purchase and energy costs in the process.

MAGNA is always improving

Grundfos continues to set the pace for circulator pumps and is the obvious choice if you are looking for the most energy-efficient solution and fastest return on investment.

To achieve the groundbreaking MACNA3 energy efficiency, we have further optimized pump hydraulics and incorporated our patented differential pressure sensor, while switching to a composite rotor can and a compact stator that minimizes losses in the motor.

The result is a highly efficient and future-proof circulator exceeding even future energy standards.

The all-purpose circulator

Like its predecessor, MACNA3 is the ideal pump for heating and cooling applications as well as domestic hot water circulation systems. It is designed to handle liquids down to 14°F, which makes it suitable for both tough industrial tasks and ground source heat pump systems (GSHP). Furthermore, the liquid temperature (14°F to 230°F) is now independent of the ambient temperature (32°F to 104°F). So whether your project requires heating or cooling – MACNA3 is the pump for you.



INTRODUCING: YOUR PERFECT CONTROL MODE

Intelligent control saves time and energy

The MAGNA3 gives you the full range of control mode options you would expect from a state-of-the-art circulator pump. But the intelligent modes – AUTODiAPr and FLOWiSert – set MACNA3 apart from the competition. Furthermore, the FLOWiSert and Automatic Night Setback control functions are applicable with all MACNA3 control modes.

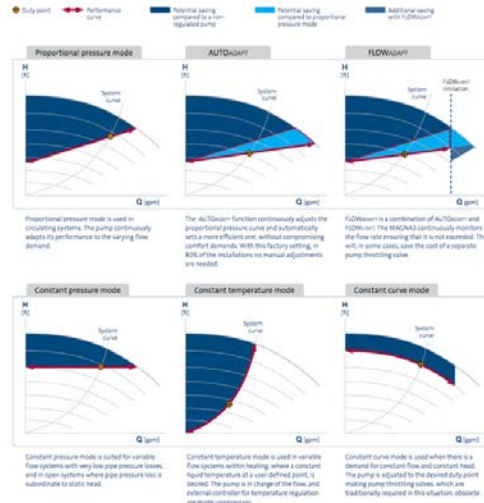

Figure 37 – HPCP Manufacturer Cut Sheet Introduction

INTELLIGENT SOLUTIONS

Built for building management

Optional CIM modules support all common fieldbus standards, making MAGNA3 the perfect addition to any BMS system.

Heat energy meter

The MAGNA3 features a built-in heat energy meter that can monitor system heat energy distribution and consumption in order to avoid excessive energy bills caused by system imbalances. The heat energy meter has an accuracy of +/-1% to +/-10%, depending on the duty point, and will save you the cost of installing a separate energy metering device within your system.

No pump throttling valves

The new FLOWADAPT function and FLOWADAPT control mode allow you to set a maximum flow limit for your MAGNA3 pump. The pump continuously monitors the flow rate to ensure the desired maximum flow is not exceeded. This eliminates the need for pump throttling valves and hereby improves the system's overall energy efficiency. To meet system flow limitations, the pump will adjust its performance to a given setpoint, which dramatically cuts energy consumption.

Wireless communication between two single pumps

MAGNA3 is supplied with wireless technology which enables it to connect to another MAGNA3 pump. Using the built-in wizard, connection to a parallel coupled pump is quick and easily obtained. The two pumps are now controlled jointly in either cascade mode, alternating mode or pump back-up mode.



More than a pump:

The MAGNA3 has a built-in energy meter and a flow limiting function which makes up for a pump throttling valve.



More I/O for system intelligence

With the addition of an extra configurable relay and an analog input, the complete MAGNA3 I/O package allows for better system monitoring and optimal pump regulation.

MAGNA3 I/O package

1 x analog input (0-10V/4-20mA) for differential pressure sensor, constant temperature control, heat energy metering or external set point 2 x relay outputs configurable as alarm, ready or operation 3 x digital inputs for external start/stop, max. curve and min. curve

Easy optimization

The innovative 3D Work Log and Duty Point Over Time curve make optimization simple and accurate. The two new features give you the details of the pump's performance since the day it was installed as well as the details of its operating conditions, such as average temperature and power consumption. Based on this, it is easy to find the optimal replacement pump, perfect optimization plan or carry out troubleshooting.

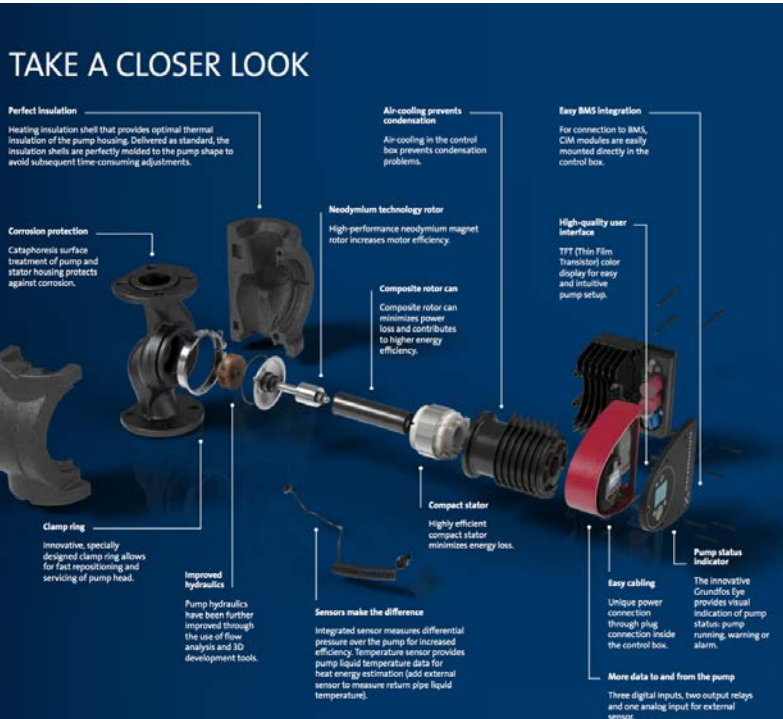

TAKE A CLOSER LOOK

Perfect insulation

Heating insulation shell that provides optimal thermal insulation of the pump housing. Delivered as standard, the insulation shells are perfectly molded to the pump shape to avoid subsequent time-consuming adjustments.

Corrosion protection

Cathaphoresis surface treatment of pump and stator housing protects against corrosion.

Clamp ring

Innovative, specially designed clamp ring allows for fast repositioning and servicing of pump head.

Improved hydraulics

Pump hydraulics have been further improved through the use of flow analysis and 3D development tools.

Neodymium technology rotor

High-performance neodymium magnet rotor increases motor efficiency.

Composite rotor can

Composite rotor can minimizes power loss and contributes to higher energy efficiency.

Sensors make the difference

Integrated sensor measures differential pressure over the pump for increased efficiency. Temperature sensor provides pump liquid temperature data for heat energy estimation (add external sensor to measure return pipe liquid temperature).

Compact stator

Highly efficient compact stator minimizes energy loss.

Easy BMS integration

For connection to BMS, CIM modules are easily mounted directly in the control box.

High-quality user interface

TFT Thin Film Transistor color display for easy and intuitive pump setup.

Easy cabling

Unique power connection through plug connection inside the control box.

More data to and from the pump

Three digital inputs, two output relays and one analog input for external sensor.

Accessories

Grundfos GO

Grundfos GO gives you intuitive handheld pump control and full access to the Grundfos online tools on the go.

CIM modules

For connection to BMS, CIM modules with the following fieldbus standards can be added: Lon, Profibus, Modbus, SMS/CSM/EPDS and BACnet. In addition, the GENibus is also available.

Insulation shells

Insulation shells that prevent condensation and corrosion in air conditioning and ground source heat pump systems.

Reliability through generations

The MAGNA3 hardware is a third generation platform built on Grundfos' 65 years of pump experience, while the pump's new self-protecting electronics prove that we are still the industry's electronic pump pioneers.

1 million test hours

At Grundfos, we believe in the value of thorough testing. The MAGNA3 has been submitted to more than 1 million test hours in extreme conditions, including alternating pressure tests, high humidity tests as well as high and low-temperature tests.

PRODUCT RANGE

Pump type	Port-to-port length (N)	Single pump, cast iron		Single pump, stainless		Twin pump, Cast iron
		T15V	208-230V	T15V	208-230V	
MAGNA3 32-60 F	6-1/2"	98126820	98126820	98126822	98126822	—
MAGNA3 32-100 F	6-1/2"	98126824	98126824	98126826	98126826	—
MAGNA3 40-80 F	8-1/2"	98126820	98126828	98126802	98126830	—
MAGNA3 40-120 F	8-1/2"	98126804	98126832	98126806	98126834	—
MAGNA3 40-180 F	8-1/2"	98126808	98126836	98126810	98126838	—
MAGNA3 50-80 F	9-1/2"	98126812	98126840	98126814	98126842	—
MAGNA3 50-150 F	11"	98126816	98126844	98126818	98126846	—
MAGNA3 65-120 F	13-1/2"	98124696	98126848	98124702	98126850	—
MAGNA3 65-150 F	13-1/2"	—	98126852	—	98126854	98126863
MAGNA3 80-100 F	14-1/4"	—	98126856	—	98126858	98126864
MAGNA3 100-120 F	17-3/4"	—	98126860	—	98126862	98126864



Temperature range (all models):

Liquid temperature: 14°F up to 230°F
Ambient temperature: 32°F up to 104°F

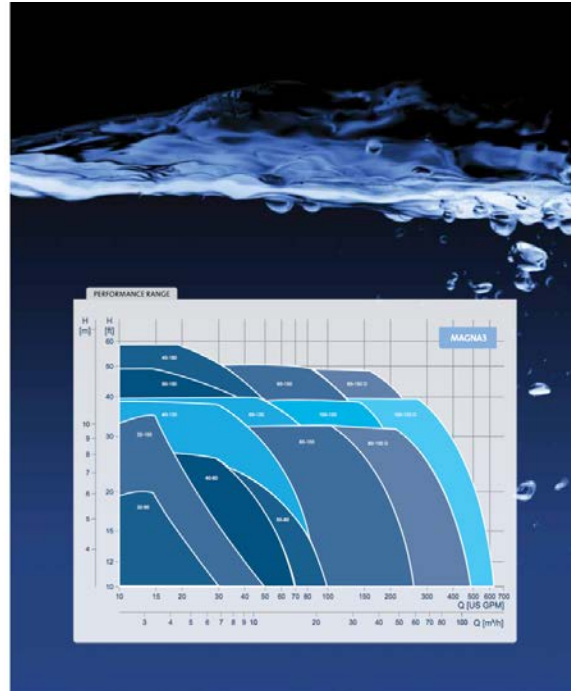

Figure 39 – HPCP Manufacturer Cut Sheet – Product Range

VI. Deployment Guidance (GSA Only)

A. INSTALLATION AND COMMISSIONING

The technicians who installed the pump estimated that it would take around 5 hours of labor to remove the old pump and install a new HPCP. The same technicians estimated 3 hours to remove and install a standard pump, with the increased time requirements coming from the need to program the new HPCP.

B. IMPACT ON FACILITY OPERATIONS

The O&M staff did not report any steep learning curve with the pump. In general, the DHWP installation was very straightforward, and there were no issues with programming the HPCP Model 40-80 pumps.

C. INFORMATION TECHNOLOGY SECURITY AND CONTINUITY OF CONNECTIVITY

If there is Wi-Fi available in the mechanical room where the pumps are installed, the GSA site could download the smart phone app for the pumps and use the application to help analyze pump operation, as needed. As noted above, the IT security concerns for this pump were not evaluated during this demonstration and would need to be approved by GSA IT as a first step.

D. TECHNOLOGY MARKET READINESS

There are no site-specific constraints other than the pump size, which needs to be smaller than ~ 2.5 HP. This HPCP has been commercially available for 3 years and has undergone 1 million hours of testing before release. This HPCP has a TRL of 9.

E. TECHNOLOGY SPECIFICATIONS

BASIC FUNCTION

Application

Standard circulator pumps are constant speed and use a less efficient induction motor and are typically oversized in common heating, cooling and DHW applications. The HPCP is equipped with an EMC with electronic speed control based on PM and compact stator motor technology and a built-in logic for energy optimization and energy management and reporting.

HPCPs should be considered on any standard constant volume circulator pump system, such as DHW recirculation pumps, heating, cooling, GSHP and constant speed SHW pumps that are 2.5 HP or smaller. HPCPs will be targeted for DHW recirculation replacement when the current pump needs to be replaced, operates for 40 or more hours per week and has electric rates of 6 cents/kWh or more.

Sites with a 7-month heating season, operating 24 hours per day during the heating system at an electric rate of \$0.12/kWh or more with a \$400 utility rebate were shown to be cost effective.

DESIGN REQUIREMENTS

The new pump must be a variable speed wet rotor inline circulator pump. The pump must be a standard product of a single pump manufacturer. The pump, motor and variable speed drive must be an integral product designed and built by the same manufacturer.

Pump Sizing

Because differential pressure and accurate flow readings are not readily available for smaller constant volume circulator pumps, one of the following methods must be used to right-size the pumps:

- Determine the pipe sizes and lengths and calculate the actual head loss from the pipes. That will provide a means of estimating the gpm and head required for an HPCP.
- Observe supply and return temperature differential to make an educated guess about the existing pump's suitability for that system. For example, if the Delta-T is extremely small (2–5°F), the pump is most likely oversized.

Ratings

Maximum pressure	175 PSIG
Minimum media temperature:	14°F
Maximum media temperature	230°F
Maximum sound pressure level:	43dB(A)
Voltage:	[1 x 115 V +/-10%] [1 x 208–230 V +/-10%]

Motor

Motor must be four-pole PM motor and tested with the pump as one unit by the same manufacturer.

Each motor must be equipped with electronic speed control based on PM and compact stator motor technology and tested as one unit by the same manufacturer.

The PM motor control must utilize an energy optimization algorithm to minimize energy consumption by reducing the factory-set set point and adjust to system characteristics. This must be accomplished without the need of any external sensors or input.

Operating Modes

The pump must have built-in control modes that allow the pump to be operated in different modes without needing to be connected to the local building automation system. The pump must be capable of operating in the following control modes at a minimum:

- *AutoAdapt*: During operation, the pump automatically reduces the factory-set set point and adjusts it to the actual system characteristic.
- *FLOWLIMIT*: It must be possible for the user to select a maximum flow that the pump will not exceed to eliminate the need for additional throttling valves. The pump must operate per selected control mode but will limit speed to not exceed the user-specified flow limit.

- *Constant temperature:* The pump must adjust speed to maintain a constant media temperature in the flow pipe in which the pump is installed.
- *Constant differential temperature:* The pump must adjust speed to maintain a constant temperature drop between the flow pipe in which the pump is installed and a user-installed temperature sensor.

Sensors and Communication

The pump must have a sensor integrated directly into the pump housing with four lines consisting of ground, supply and two signals for differential pressure and media temperature.

The pump module must have one analog input configurable for either 4–20 mA or 0–10-V DC input signal configurable for external temperature or pressure sensor or set point influence. Sensor input must have three wires for ground, supply and signal. The supply for external analog input must be 24 V DC +/-10% at 22 mA reference to ground.

The pump must have three digital inputs galvanically isolated from the main supply by a reinforced insulation according to UL60730.

The pump module must have two output relays. Each relay must be configurable for alarm, reading or operating indication. Each relay must have three screw terminals . Output relay contacts must be rated for maximum 250-V AC at 2A and minimum 5-V DC at 20 mA. Each must have galvanic isolation from the internal supply by reinforced insulation according to UL60730.

The pump must be capable of accepting an optional add-on module for integration into building management systems:

- LonWorks
- Bacnet
- Modbus
- Profibus.

The pump module must have wireless connectivity for two pumps to communicate with one another or for the pump to communicate to a mobile device with additional hardware.

The communication range must be at a minimum within 30 ft. of the pump without walls or barriers.

Two identical pumps must be capable of wireless communication with one another to operate as a two-pump system in:

- Duty/standby
- Alternating mode, pumps alternate operation every 24 hours
- Cascade operation with both pumps running simultaneously in constant differential pressure mode.

PERFORMANCE CRITERIA

Energy Efficiency Index The pump must be labeled on the nameplate as having an energy efficiency index of no more than 0.20.

QUALITY ASSURANCE

Manufacturer Qualifications

A qualified manufacturer has a minimum of 10 years of documented experience manufacturing HPCPs.

Installer Qualifications A firm that is authorized by the HPCP manufacturer to install the pumps within guidelines set forth by the manufacturer.

REFERENCE STANDARDS

UL 778 Standard for Safety Motor Operated Water Pumps

UL 60730-1A UL Standard for Safety Automatic Electrical Controls for Household and Similar Use

The HPCP is also subject to requirements of applicable portions of the following standards:

Hydraulic Institute

ANSI	American National Standards Institute
ASTM	American Society for Testing and Materials
CSA	Canadian Standards Association
ETL	ETL Listed Mark by Intertek Testing Services
IEEE	Institute of Electrical and Electronics Engineers
ISO	International Standards Organization
NEMA	National Electrical Manufacturers Association
NEC	National Electrical Code
UL	Underwriters Laboratories, Inc.

WARRANTY

Warranty Period The warranty period must be a non-prorated period of 24 months from date of installation, not to exceed 30 months from date of manufacture. Warranty must cover pump, motor and terminal box as a complete unit.

OPERATIONS & MAINTENANCE

O&M

Pumped liquids must be within the specified water/glycol mixtures for the pump. The operating fluid temperatures, system pressure and ambient temperature must all be within the manufacturer's acceptable ranges. Installation and O&M procedures provided by the manufacturer must be followed for all HPCP installations.
