



# GENERAL SERVICES ADMINISTRATION ALTERNATE PATH ANALYSIS & DESIGN GUIDELINES FOR PROGRESSIVE COLLAPSE RESISTANCE



OCTOBER 24, 2013

REVISION 1, JANUARY 28, 2016

APPROVED FOR PUBLIC RELEASE;  
DISTRIBUTION UNLIMITED



## TABLE OF CONTENTS

<b>1</b>	<b>INTRODUCTION .....</b>	<b>1</b>
1.1	PURPOSE.....	1
1.2	GUIDELINE PHILOSOPHY .....	1
1.2.1	DEFINITION OF PROGRESSIVE COLLAPSE .....	1
1.2.2	THREAT DEPENDENT APPROACH.....	1
1.3	APPLICABILITY .....	2
1.4	HOW TO USE THIS DOCUMENT .....	2
1.5	DOCUMENT ORGANIZATION.....	2
1.6	SUMMARY OF THE PROGRESSIVE COLLAPSE DESIGN PROCEDURE .....	3
1.6.1	ALTERNATE PATH.....	3
1.6.2	REDUNDANCY REQUIREMENTS .....	3
1.7	REFERENCES .....	3
<b>2</b>	<b>APPLICABILITY .....</b>	<b>4</b>
2.1	NEW CONSTRUCTION AND BUILDING ADDITIONS.....	4
2.2	EXISTING BUILDINGS.....	4
2.3	FACILITY SECURITY LEVELS (FSL) .....	4
2.3.1	FSL I & II .....	5
2.3.2	FSL III & IV .....	5
2.3.3	FSL V.....	5
<b>3</b>	<b>DESIGN PROCEDURES.....</b>	<b>7</b>
3.1	TIE FORCES .....	7
3.2	ALTERNATE PATH METHOD .....	7
3.2.1	GENERAL .....	7
3.2.2	ALTERNATIVE RATIONAL ANALYSIS .....	7
3.2.3	LOAD AND RESISTANCE FACTOR DESIGN FOR ALTERNATE PATH METHOD .....	8
3.2.4	PRIMARY AND SECONDARY COMPONENTS .....	9
3.2.5	FORCE-AND DEFORMATION-CONTROLLED ACTIONS.....	9
3.2.6	EXPECTED AND LOWER BOUND STRENGTH.....	10
3.2.7	MATERIAL PROPERTIES.....	11
3.2.8	COMPONENT FORCE AND DEFORMATION CAPACITIES.....	11
3.2.9	REMOVAL OF LOAD-BEARING ELEMENTS FOR THE ALTERNATE PATH METHOD .....	12
3.2.10	STRUCTURAL ACCEPTANCE CRITERIA.....	17
3.2.11	LINEAR STATIC PROCEDURE.....	19



3.2.12	NONLINEAR STATIC PROCEDURE .....	26
3.2.13	NONLINEAR DYNAMIC PROCEDURE .....	29
3.3	<del>ENHANCED LOCAL RESISTANCE</del> .....	31
3.4	REDUNDANCY REQUIREMENTS .....	31
3.4.1	GENERAL .....	31
3.4.2	LOAD REDISTRIBUTION SYSTEMS .....	31
<b>4</b>	<b>REINFORCED CONCRETE .....</b>	<b>37</b>
4.1	MATERIAL PROPERTIES FOR REINFORCED CONCRETE.....	37
4.2	STRENGTH REDUCTION FACTOR $\phi$ FOR REINFORCED CONCRETE .....	37
4.3	<del>TIE FORCE REQUIREMENTS FOR REINFORCED CONCRETE</del> .....	37
4.4	ALTERNATE PATH REQUIREMENTS FOR REINFORCED CONCRETE .....	37
4.4.1	GENERAL .....	37
4.4.2	FLEXURAL MEMBERS AND JOINTS .....	37
4.4.3	MODELING AND ACCEPTANCE CRITERIA FOR REINFORCED CONCRETE .....	38
4.5	<del>ENHANCED LOCAL RESISTANCE FOR REINFORCED CONCRETE</del> .....	38
<b>5</b>	<b>STRUCTURAL STEEL.....</b>	<b>43</b>
5.1	MATERIAL PROPERTIES FOR STRUCTURAL STEEL .....	43
5.2	STRENGTH REDUCTION FACTOR $\phi$ FOR STRUCTURAL STEEL.....	43
5.3	<del>TIE FORCE REQUIREMENTS FOR STEEL</del> .....	43
5.4	ALTERNATE PATH METHOD FOR STEEL .....	43
5.4.1	GENERAL .....	43
5.4.2	CONNECTION ROTATIONAL CAPACITY .....	43
5.4.3	MODELING AND ACCEPTANCE CRITERIA FOR STRUCTURAL STEEL .....	43
5.5	<del>ENHANCED LOCAL RESISTANCE FOR STRUCTURAL STEEL</del> .....	44
<b>6</b>	<b>MASONRY .....</b>	<b>47</b>
6.1	MATERIAL PROPERTIES FOR MASONRY .....	47
6.2	STRENGTH REDUCTION FACTOR $\phi$ FOR MASONRY.....	47
6.3	<del>TIE FORCE REQUIREMENTS FOR MASONRY</del> .....	47
6.4	ALTERNATE PATH METHOD FOR MASONRY.....	47
6.4.1	GENERAL .....	47
6.4.2	MODELING AND ACCEPTANCE CRITERIA FOR MASONRY .....	47
6.5	<del>ENHANCED LOCAL RESISTANCE FOR MASONRY</del> .....	47
<b>7</b>	<b>WOOD.....</b>	<b>48</b>
7.1	MATERIAL PROPERTIES FOR WOOD .....	48



7.2	STRENGTH REDUCTION FACTOR $\phi$ FOR WOOD.....	48
7.3	TIME EFFECT FACTOR $\lambda$ FOR WOOD.....	48
7.4	<del>TIE FORCE REQUIREMENTS FOR WOOD</del> .....	48
7.5	ALTERNATE PATH METHOD FOR WOOD .....	48
7.5.1	GENERAL .....	48
7.5.2	MODELING AND ACCEPTANCE CRITERIA FOR WOOD .....	48
7.6	<del>ENHANCED LOCAL RESISTANCE FOR WOOD</del> .....	49
<b>8</b>	<b>COLD-FORMED STEEL.....</b>	<b>50</b>
8.1	MATERIAL PROPERTIES FOR COLD-FORMED STEEL.....	50
8.2	STRENGTH REDUCTION FACTOR $\phi$ FOR COLD-FORMED STEEL .....	50
8.3	<del>TIE FORCE REQUIREMENTS FOR COLD-FORMED STEEL</del> .....	50
8.4	ALTERNATE PATH METHOD FOR COLD-FORMED STEEL.....	50
8.4.1	GENERAL .....	50
8.4.2	MODELING AND ACCEPTANCE CRITERIA FOR COLD-FORMED STEEL .....	50
8.5	<del>ENHANCED LOCAL RESISTANCE FOR COLD-FORMED STEEL</del> .....	50
<b>B1</b>	<b>DEFINITIONS .....</b>	<b>1</b>
<b>C1</b>	<b>INTRODUCTION .....</b>	<b>C1</b>
C1.1	PURPOSE.....	C1
C1.2	GUIDELINE PHILOSOPHY.....	C2
C1.2.1	DEFINITION OF PROGRESSIVE COLLAPSE.....	C2
C1.2.2	THREAT DEPENDENT APPROACH.....	C3
C1.3	APPLICABILITY .....	C3
C1.4	HOW TO USE THIS DOCUMENT .....	C3
C1.5	DOCUMENT ORGANIZATION.....	C3
C1.6	SUMMARY OF THE PROGRESSIVE COLLAPSE DESIGN PROCEDURE .....	C3
<b>C2</b>	<b>APPLICABILITY .....</b>	<b>C4</b>
C2.1	NEW CONSTRUCTION AND BUILDING ADDITIONS.....	C4
C2.2	NEW VS. EXISTING CONSTRUCTION .....	C4
C2.3	FACILITY SECURITY LEVELS (FSL) .....	C5
<b>C3</b>	<b>DESIGN PROCEDURES.....</b>	<b>C6</b>
C3.1	TIE FORCES .....	C6
C3.2	ALTERNATE PATH METHOD .....	C6
C3.2.1	GENERAL .....	C6



C3.2.2	ALTERNATIVE RATIONAL ANALYSIS .....	C7
C3.2.3	LOAD AND RESISTANCE FACTOR DESIGN .....	C8
C3.2.4	PRIMARY AND SECONDARY COMPONENTS .....	C8
C3.2.5	FORCE-AND DEFORMATION-CONTROLLED ACTIONS.....	C9
C3.2.6	EXPECTED AND LOWER BOUND STRENGTH.....	C9
C3.2.7	MATERIAL PROPERTIES.....	C9
C3.2.8	COMPONENT FORCE AND DEFORMATION CAPACITIES.....	C9
C3.2.9	REMOVAL OF LOAD BEARING ELEMENTS FOR ALTERNATE PATH METHOD .....	C9
C3.2.10	STRUCTURE ACCEPTANCE CRITERIA .....	C9
C3.2.11	LINEAR STATIC PROCEDURE.....	C10
C3.2.12	NONLINEAR STATIC PROCEDURE .....	C12
C3.2.13	NONLINEAR DYNAMIC PROCEDURE .....	C13
C3.3	<del>ENHANCED LOCAL RESISTANCE.....</del>	<del>C13</del>
C3.4	REDUNDANCY REQUIREMENTS.....	C14
C3.4.1	LOCATION REQUIREMENTS .....	C14
C3.4.2	STRENGTH REQUIREMENTS.....	C14
C3.4.3	STIFFNESS REQUIREMENTS.....	C15
<b>C4</b>	<b>REINFORCED CONCRETE.....</b>	<b>C15</b>
C4.1	MATERIAL PROPERTIES FOR REINFORCED CONCRETE .....	C15
C4.2	STRENGTH REDUCTION FACTOR $\phi$ FOR REINFORCED CONCRETE .....	C15
C4.3	<del>TIE FORCE REQUIREMENTS FOR REINFORCED CONCRETE.....</del>	<del>C15</del>
C4.4	ALTERNATE PATH REQUIREMENTS FOR REINFORCED CONCRETE .....	C15
C4.4.1	GENERAL .....	C15
C4.4.2	FLEXURAL MEMBERS AND JOINTS .....	C15
C4.4.3	MODELING AND ACCEPTANCE CRITERIA FOR REINFORCED CONCRETE .....	C15
C4.5	<del>ENHANCED LOCAL RESISTANCE FOR REINFORCED CONCRETE.....</del>	<del>C16</del>
<b>C5</b>	<b>STRUCTURAL STEEL.....</b>	<b>C16</b>
C5.1	MATERIAL PROPERTIES FOR STRUCTURAL STEEL .....	C16
C5.2	STRENGTH REDUCTION FACTOR $\phi$ FOR STRUCTURAL STEEL.....	C16
C5.3	<del>TIE FORCE REQUIREMENTS FOR STEEL .....</del>	<del>C16</del>
C5.4	ALTERNATE PATH METHOD FOR STEEL .....	C16
C5.4.1	GENERAL .....	C16
C5.4.2	CONNECTION ROTATIONAL CAPACITY.....	C16
C5.4.3	MODELING AND ACCEPTANCE CRITERIA FOR STRUCTURAL STEEL.....	C17



BEST PRACTICE RECOMMENDATION .....	C17
<b>C6 MASONRY .....</b>	<b>C23</b>
<b>C7 WOOD .....</b>	<b>C23</b>
<b>C8 COLD-FORMED STEEL .....</b>	<b>C23</b>
<b>D1 INTRODUCTION .....</b>	<b>D1</b>
<b>D2 BASELINE PRELIMINARY DESIGN .....</b>	<b>D1</b>
D2.1 DESIGN AND MODELING ASSUMPTIONS.....	D1
D2.1.1 CONNECTIONS.....	D1
D2.1.2 ELEMENTS.....	D1
D2.1.3 LOADING .....	D1
D2.1.4 MEMBER SIZES.....	D2
<b>D3 LINEAR STATIC PROCEDURE .....</b>	<b>D9</b>
D3.1 DCR AND IRREGULARITY CHECK .....	D9
D3.2 COLUMN REMOVAL LOCATIONS.....	D9
D3.3 ANALYTICAL MODELING.....	D10
D3.3.1 PRIMARY AND SECONDARY ELEMENT CLASSIFICATION .....	D10
D3.3.2 CLASSIFICATION OF DEFORMATION AND FORCE-CONTROLLED ACTIONS.....	D10
D3.3.3 M-FACTORS.....	D11
D3.3.3.1 TYPICAL BEAM COMPONENT .....	D11
D3.3.3.2 BEAM COLUMN JOINT .....	D13
D3.3.3.3 COLUMN.....	D13
D3.3.4 LOAD INCREASE FACTORS .....	D20
D3.3.5 LOAD COMBINATIONS.....	D20
<b>D4 ALTERNATIVE PATH ANALYSIS .....</b>	<b>D21</b>
D4.1 DEVELOP PRELIMINARY MODEL .....	D21
D4.2 DEFINE LOAD CASES AND ASSIGN LOADS.....	D22
D4.3 RUN ANALYSIS AND COMPARE TO ACCEPTANCE CRITERIA .....	D24
D4.3.1 SECONDARY COMPONENT CHECKS .....	D41
<b>D5 REDUNDANCY REQUIREMENTS .....</b>	<b>D48</b>
D5.1 LOCATION REQUIREMENTS .....	D48
D5.2 STRENGTH REQUIREMENTS.....	D48
D5.2.1 COLUMN REMOVAL 1.....	D49
D5.3 STIFFNESS REQUIREMENTS.....	D52



D5.3.1	COLUMN REMOVAL 1.....	D52
<b>E1</b>	<b>INTRODUCTION .....</b>	<b>E1</b>
<b>E2</b>	<b>BASELINE PRELIMINARY DESIGN.....</b>	<b>E1</b>
E2.1	DESIGN AND MODELING ASSUMPTIONS.....	E1
E2.1.1	CONNECTIONS.....	E1
E2.1.2	ELEMENTS.....	E2
E2.1.3	LOADING .....	E2
E2.1.4	MEMBER SIZES.....	E3
<b>E3</b>	<b>LINEAR STATIC PROCEDURE.....</b>	<b>E9</b>
E3.1	DCR AND IRREGULARITY CHECK .....	E9
E3.2	COLUMN REMOVAL LOCATIONS.....	E9
E3.3	ANALYTICAL MODELING.....	E10
E3.3.1	PRIMARY AND SECONDARY ELEMENT CLASSIFICATION .....	E10
E3.3.2	CLASSIFICATION OF DEFORMATION AND FORCE-CONTROLLED ACTIONS.....	E10
E3.3.3	M-FACTORS.....	E11
E3.3.4	LOAD INCREASE FACTORS .....	E15
E3.3.5	LOAD COMBINATIONS.....	E16
<b>E4</b>	<b>ALTERNATIVE PATH ANALYSIS .....</b>	<b>E17</b>
E4.1	DEVELOP PRELIMINARY MODEL .....	E17
E4.2	DEFINE LOAD CASES AND ASSIGN LOADS.....	E18
E4.3	RUN ANALYSIS AND COMPARE TO ACCEPTANCE CRITERIA .....	E20
E4.3.1	SECONDARY COMPONENT CHECKS .....	E30
<b>E5</b>	<b>REDUNDANCY REQUIREMENTS.....</b>	<b>E38</b>
E5.1	LOCATION REQUIREMENTS .....	E38
E5.2	STRENGTH REQUIREMENTS.....	E38
E5.2.1	COLUMN REMOVAL 1.....	E39
E5.3	STIFFNESS REQUIREMENTS.....	E42
E5.3.1	COLUMN REMOVAL 1.....	E42
APPENDIX A – REFERENCES		
APPENDIX B – DEFINITIONS		
APPENDIX C – COMMENTARY		
APPENDIX D – REINFORCED CONCRETE EXAMPLE		
APPENDIX E – STRUCTURAL STEEL EXAMPLE		



## LIST OF FIGURES

Figure 2.1. Applicability Flow Chart .....	6
Figure 3.1.....	7
Figure 3.2.....	7
Figure 3.3.....	7
Figure 3.4.....	7
Figure 3.5.....	7
Figure 3.6.....	7
Figure 3.7. Definition of Force-Controlled and Deformation-Controlled Actions, from ASCE 41 [10] .....	10
Figure 3.8. Removal of Column from Alternate Path Model .....	12
Figure 3.9. Location of External Column Removal.....	15
Figure 3.10. Location of Internal Column Removal .....	15
Figure 3.11. Location of External Load-Bearing Wall Removal .....	16
Figure 3.12. Location of Internal Load-Bearing Wall Removal.....	16
Figure 3.13. Allowable Extents of Collapse for Interior and Exterior Column Removal in Plan .....	18
Figure 3.14. Allowable Extents of Collapse for Interior and Exterior Column Removal in Elevation .....	18
Figure 3.15. Loads and Load Locations for External and Internal Column Removal for Linear and Nonlinear Static Models (Left Side Demonstrates External Column Removal; Right Side Shows Internal Column Removal).....	23
Figure 3.16. Loads and Load Locations for External and Internal Wall Removal for Linear and Nonlinear Static Models (Left Side Demonstrates External Wall Removal; Right Side Shows Internal Wall Removal) .....	24
Figure 3.17. Plan View of Strength Definitions for Load Redistributing Systems.....	33
Figure 3.18. Elevation View of Strength Definitions for Load Redistributing Systems.....	34
Figure 3.19. Plan View of Stiffness Definitions for Load Redistributing Systems .....	35
Figure 3.20. Definition of Stiffness based on Various Support Conditions .....	36
Figure 3.21. Elevation View of Stiffness Definitions for Load Redistributing Systems.....	36
Figure D2.1: Building Floor Plan (Levels 2-6) .....	D4
Figure D2.2: Building Roof Plan.....	D5
Figure D2.3: Building Elevation along GL A .....	D6
Figure D2.4: Building Elevation along B-F (Interior).....	D7
Figure D2.5: Building Elevation along Gridline 1 and 4.....	D8





Figure D3.1: Column Removal Locations.....	D9
Figure D4.1: Isometric View of SAP Model .....	D22
Figure D4.2: Screenshot from SAP2000 for Load Pattern Assignment .....	D23
Figure D4.3: Summary of Load Pattern Assignments .....	D23
Figure D4.4: Load Case Input in SAP .....	D24
Figure D4.5: Column Removal 1 Original Design along Gridline A .....	D25
Figure D4.6: Column Removal 1 Original Design along Gridline B .....	D25
Figure D4.7: Column Removal 1 Original Design along Gridline 4 .....	D26
Figure D4.8: Column Removal 2 Original Design along Gridline 4 .....	D26
Figure D4.9: Column Removal 2 Original Design along Gridline C .....	D27
Figure D4.10: Column Removal 2 Original Design along Gridline D .....	D27
Figure D4.11: Column Removal 2 Original Design along Gridline E .....	D28
Figure D4.12: Column Removal 3 Original Design along Gridline G .....	D28
Figure D4.13: Column Removal 3 Original Design along Gridline F .....	D29
Figure D4.14: Column Removal 3 Original Design along Gridline 1 .....	D29
Figure D4.15: Column Removal 1 Upgraded Design along Gridline A .....	D38
Figure D4.16: Column Removal 1 Upgraded Design along Gridline B .....	D38
Figure D4.17: Column Removal 1 Upgraded Design along Gridline 4 .....	D39
Figure D4.18: Column Removal 2 Upgraded Design along Gridline 4 .....	D39
Figure D4.19: Column Removal 2 Upgraded Design along Gridline D .....	D40
Figure D4.20: Column Removal 3 Upgraded Design along Gridline G .....	D40
Figure D4.21: Roof Plan showing Secondary Pan Joist Evaluated .....	D41
Figure D4.22: Displacement of Girder along to Gridline A with Deformation Controlled Action .....	D43
Figure D4.23: Displacement of Girder along to Gridline B with Deformation Controlled Action .....	D43
Figure D4.24: Shear & Moment in Simply-Supported Beam with End Moments and Uniform Loading...	D44
Figure D4.25: Displacement of Beam along Gridline A with Force Controlled Action .....	D46
Figure D4.26: Displacement of Beam along Gridline B with Force Controlled Action .....	D46
Figure D5.1: Load Redistribution System for Column Removal 1 .....	D50
Figure D5.2: Load Redistribution System at Level 3, 5, and 7 for Column Removal 1 .....	D50
Figure E2.1: WUF Connection w/ Bolted Web .....	E2
Figure E2.2: Simple Shear Tab Connection .....	E2



Figure E2.3: Building Elevations (South & Interior).....	E5
Figure E2.4: Building Elevations (North, West & East) .....	E6
Figure E2.5: Building Level 2 and 3 Floor Plans .....	E7
Figure E2.6: Building Level 4 and Roof Plans .....	E8
Figure E3.1: Column Removal Locations .....	E9
Figure E4.1: Isometric View of SAP Model .....	E17
Figure E4.2: Screenshot from SAP2000 for Load Pattern Assignment.....	E18
Figure E4.3: Summary of Load Pattern Assignments .....	E19
Figure E4.4: Load Case Input in SAP .....	E19
Figure E4.5: Column Removal 1 Original Design along Gridline C .....	E20
Figure E4.6: Column Removal 1 Original Design along Gridline B .....	E21
Figure E4.7: Column Removal 1 Original Design along Gridline 6 .....	E21
Figure E4.8: Column Removal 3 Original Design along Gridline 10.....	E22
Figure E4.9: Column Removal 3 Original Design along Gridline 9 .....	E22
Figure E4.10: Column Removal 3 Original Design along Gridline B.....	E23
Figure E4.11: Column Removal 3 Original Design along Gridline C.....	E23
Figure E4.12: Column Removal 3 Original Design along Gridline A.....	E24
Figure E4.13: Column Removal 1 Upgraded Design along Gridline C.....	E26
Figure E4.14: Column Removal 1 Upgraded Design along Gridline B.....	E26
Figure E4.15: Column Removal 1 Upgraded Design along Gridline 6.....	E27
Figure E4.16: Column Removal 3 Upgraded Design along Gridline 10 .....	E27
Figure E4.17: Column Removal 3 Upgraded Design along Gridline 9.....	E28
Figure E4.18: Column Removal 3 Upgraded Design along Gridline C.....	E28
Figure E4.19: Column Removal 3 Upgraded Design along Gridline A.....	E29
Figure E4.20: Column Removal 3 Upgraded Design along Gridline B.....	E29
Figure E4.21: Displacement of Beam along Gridline C with Deformation Controlled Action .....	E31
Figure E4.22: Displacement of Beam along Gridline B with Deformation Controlled Action .....	E31
Figure E4.23: Shear & Moment in Simply-Supported Beam with End Moments and Uniform Loading ....	E33
Figure E4.24: Displacement of Beam along Gridline C with Force Controlled Action .....	E35
Figure E4.25: Displacement of Beam along Gridline B with Force Controlled Action .....	E35
Figure E5.1: Load Redistribution System for Column Removal 1 .....	E39



Figure E5.2: Load Redistribution System at Level 2 for Column Removal 1 ..... E40  
Figure E5.3: Load Redistribution System at Level 4 for Column Removal 1 ..... E40



## LIST OF TABLES

Table 1. Examples of Deformation-Controlled and Force-Controlled Actions from ASCE 41 [10] .....	10
Table 2. Calculation of Component Capacities for Nonlinear Static and Nonlinear Dynamic Procedures ...	11
Table 3. Calculation of Component Capacities for the Linear Static Procedure .....	12
Table 4. Load Increase Factors for Linear Static Analysis .....	22
Table 5. Dynamic Increase Factors ( $\Omega_v$ ) for Nonlinear Static Analysis .....	28
Table 6. Nonlinear Modeling Parameters and Acceptance Criteria for Reinforced Concrete Beams (Replacement for Table 10-7 in ASCE 41) .....	39
Table 7. Acceptance Criteria for Linear Models of Reinforced Concrete Beams (Replacement for Table 10- 13 in ASCE 41 [10]) .....	40
Table 8. Modeling Parameters and Acceptance Criteria for Nonlinear Models of Two-Way Slabs and Slab- Column Connections (Replacement for Table 10-15 in ASCE 41 [10]) .....	41
Table 9. Acceptance Criteria for Linear Models of Two-Way Slabs and Slab-Column Connections (Replacement for Table 10-16 in ASCE 41 [10]) .....	42
Table 10. Acceptance Criteria for Linear Static Modeling of Steel Frame Connections .....	45
Table 11. Modeling Parameters and Acceptance Criteria for Nonlinear Modeling of Steel Frame Connections .....	46
Table D12: Gravity Loading .....	D2
Table D13: Preliminary Member Sizes .....	D2
Table D14: Examples of Deformation-Controlled and Force-Controlled Actions from ASCE 41 .....	D10
Table D15: Model Requirements for Deformation and Force-Controlled Actions .....	D10
Table D16: Beam Component m-factors for Deformation Controlled Actions of Primary Components ...	D14
Table D17: Column Component m-factors for Deformation & Force Controlled Actions of Primary Components .....	D17
Table D18: Load Increase Factors ( $\Omega$ ) .....	D20
Table D19: Upgraded Sections .....	D30
Table D20: Upgraded beam m-factors .....	D32
Table D21: Redesigned Column m-factors .....	D34
Table E22: Gravity Loading .....	E2
Table E23: Examples of Deformation-Controlled and Force-Controlled Actions from ASCE 41 .....	E10
Table E24: Model Requirements for Deformation and Force-Controlled Actions .....	E10
Table E25: Beam Component m-factors for Deformation Controlled Actions of Primary Components ....	E14



Table E26: Column Component m-factors for Deformation & Force Controlled Actions of Primary Components .....	E14
Table E27: Load Increase Factors ( $\Omega$ ) .....	E16
Table E28: Re-designed beam m-factors .....	E24
Table E29: Redesignated Column m-factors.....	E25



## 1 INTRODUCTION

### 1.1 PURPOSE

The purpose of these Guidelines is to reduce the potential for progressive collapse in new and renovated Federal buildings. It is intended to bring a consistent level of protection in the application of progressive collapse design to Federal facilities and to bring alignment with the suite of security standards issued by the Interagency Security Committee (ISC) and the General Services Administration (GSA) in their philosophy, decision-making methodology and application. In addition, it aims to bring alignment within the industry by reducing incongruities between GSA and Department of Defense (DoD) methodologies.

To meet this purpose, these Guidelines replace the previous document "*GSA Progressive Collapse Analysis and Design Guidelines for New Federal Office Buildings and Major Modernization Projects 2003*" and provide a new, threat-dependent methodology for minimizing the potential for progressive collapse that utilizes the alternate path (AP) analysis procedures of UFC 04-023-03, *Design of Buildings to Resist Progressive Collapse* [31] and ASCE-41, *Seismic Rehabilitation of Existing Buildings* [10].

### 1.2 GUIDELINE PHILOSOPHY

These Guidelines address the need to save lives, prevent injury and protect Federal buildings, functions, and assets by minimizing the potential for progressive collapse. Consistent with *The Risk Management Process for Federal Facilities*, "ISC Risk Management Process"[26], these Guidelines take a flexible risk-based approach where requirements are driven by the security needs of the Federal tenant(s) and where implemented measures are commensurate with the level of risk. As such, the application of these Guidelines is dependent on the required level of protection as determined by the Facility Security Level (FSL) or facility-specific risk assessment.

#### 1.2.1 DEFINITION OF PROGRESSIVE COLLAPSE

For the purposes of these Guidelines, progressive collapse is defined as an extent of damage or collapse that is disproportionate to the magnitude of the initiating event. Since this definition focuses on the relative consequence or magnitude of the collapse rather than the manner in which it occurs, it is often referred to in the industry as "disproportionate" rather than "progressive" collapse.

#### 1.2.2 THREAT DEPENDENT APPROACH

This document is to be implemented in conjunction with the ISC Risk Management Process [26] and *GSA Facility Security Requirements for Explosive Devices Applicable to Facility Security Levels III and IV*, "GSA Applicability"[18], which take a threat dependent approach for reducing potential for progressive collapse. With a threat dependent approach, reduction of progressive collapse potential can be achieved either by precluding failure of load-carrying elements or by bridging over their loss. The first approach reduces the risk of progressive collapse for a defined threat by directly limiting the initial damage through hardening of structural elements. The second approach reduces the risk of progressive collapse by limiting the propagation of the initial damage, without explicit consideration for the cause of the initial event, through implementation of these Guidelines.



Where applicable and as approved by the GSA Technical Representative, execution of threat-based hardening in lieu of these Guidelines can be applied for FSL III and IV buildings in accordance with the ISC Risk Management Process [26]. Application of this alternative design methodology, including threat, performance and approval requirements is provided in Section 7.4 of the GSA Applicability document [18].

### 1.3 APPLICABILITY

The applicability of these Guidelines to specific building types is discussed in Chapter 2. The requirements contained herein are an independent set of measures for meeting the provisions of the ISC Risk Management Process [26] regarding progressive collapse. Where applicable per ISC Risk Management Process [26] based on the FSL level, these Guidelines should be used by all professionals engaged in the planning and design of new facilities or building modernization projects, including in-house Government engineers, architectural/engineering (A/E) firms and professional consultants under contract to the GSA.

These Guidelines are not applicable to facilities that have already been designed for progressive collapse under either the previous GSA guidelines [27] or the UFC 04-023-03 [31] prior to issuance of this document. These facilities are considered as benchmarked to meet the provisions of the ISC Risk Management Process [26] regarding progressive collapse and these Guidelines need not be applied.

While mandatory for GSA facilities, these Guidelines may also be used and/or adopted by any agency, organization, or private entity. The material contained herein is not intended as a warranty on the part of the Government that this information is suitable for any general or particular use. The user of this information assumes all liability arising from such use. This information should not be used or relied upon for any specific application without competent professional examination and verification.

### 1.4 HOW TO USE THIS DOCUMENT

The intent of this document is to provide guidance to reduce and/or assess the potential for progressive collapse of Federal buildings for new or existing construction. It is to be implemented in conjunction with the ISC Risk Management Process [26] and GSA Applicability [18] documents and follows the analysis methodology and performance requirements of UFC 04-023-03 [31] for Alternate Path. It also provides guidelines for incorporating redundancy into the progressive collapse resisting system to mitigate single points of failure and provide increased robustness for extreme loading scenarios not explicitly addressed in the design.

### 1.5 DOCUMENT ORGANIZATION

This document is organized into four main sections: an introductory section that discusses the overall objectives and applicability of the guidelines (Chapters 1 and 2); a section that discusses the required design procedures (Chapter 3); a section that provides material specific criteria (Chapters 4 through 8); and a series of appendices that provide additional background, guidance and design examples for implementation of these guidelines (Appendix A through E).

With the exception of the first introductory section (Chapters 1 and 2) the main body of this document incorporates the general organization and content of the UFC 04-023-03 [31] as it relates to Alternate Path only. The adopted methodology has been incorporated in its entirety such that these Guidelines are



a stand-alone document and the designer need not reference the UFC 04-023-03 [31] for its application. For clarity for those familiar with the UFC methodology, any modifications to the Alternate Path procedures are indicated in the text in accordance with the legend below, including sections of the UFC that have been removed.

- Modified or additions to text is indicated with a line in the left margin
- Deleted text is indicated with a strike-through the text

## 1.6 SUMMARY OF THE PROGRESSIVE COLLAPSE DESIGN PROCEDURE

The design procedures employed by these Guidelines aim to reduce the potential for progressive collapse by bridging over the loss of a structural element, limiting the extent of damage to a localized area (Alternate Path) and providing a redundant and balanced structural system along the height of the building.

### 1.6.1 ALTERNATE PATH

The Alternate Path method employed by these Guidelines is based on the methodology and performance requirements presented in UFC 4-023-03 [31] and ASCE-41 [10], with modifications and additions as outlined in Chapters 3 through 8. The Alternate Path method requires that the structure be able to bridge over vertical load-bearing elements that are notionally removed one at a time at specific plan and elevation locations, as required by Chapter 2. The procedures and general requirements for the Alternate Path method are provided in Chapter 3 with specific requirements for each material given in Chapters 4 through 8.

### 1.6.2 REDUNDANCY REQUIREMENTS

The Redundancy Requirements outlined in Chapter 3 shall be applied in conjunction with the Alternate Path analysis. The intent of these requirements is to distribute progressive collapse resistance up the height of the building without explicitly requiring column/wall removal scenarios at each level.

## 1.7 REFERENCES

These Guidelines incorporate provisions from other publications by dated or undated reference. These references are cited at the appropriate places in the text and the citations for the publications are listed in Appendix A References. For dated references, subsequent amendments to, or revisions of, any of these publications apply to these Guidelines only when incorporated in it by amendment or revision. For undated references, the latest edition of the referenced publication applies (including amendments).





## 2 APPLICABILITY

These Guidelines apply to GSA owned (new and existing) and new GSA lease construction. If stated as a tenant specific requirement within the Program of Requirements (POR), these Guidelines may also apply to new lease acquisitions or succeeding leases that are established through full and open competition. These Guidelines do not apply to lease renewals, extensions, expansions, or superseding and succeeding leases that are established other than through full and open competition.

### 2.1 NEW CONSTRUCTION AND BUILDING ADDITIONS

These Guidelines shall be applied to all new construction, as required by the FSL. In accordance with the ISC Risk Management Process [26], Section 5.2.1, new additions to existing buildings shall be considered as "new construction, including new building additions". Accordingly, these Guidelines shall be applied to all new additions, as required by the FSL.

For new construction, once a facility is determined as requiring progressive collapse resistance, the methodology outlined in Chapters 3 through 8 shall be executed. The methodology provides design guidance and performance requirements for incorporating progressive collapse resistance into the new design based on the Alternate Path method provided in UFC 04-023-03 [31], with modifications, additions and commentary as included herein.

### 2.2 EXISTING BUILDINGS

These Guidelines shall be applied only to existing Federal buildings (leased or Government-owned) that are undergoing a major modernization and as required by the FSL. For the purposes of these Guidelines, a major modernization is defined as a major structural renovation, such as a seismic upgrade.

For existing construction, once an existing building is determined as requiring progressive collapse resistance, the same methodology outlined in Chapters 3 through 8 shall be executed to evaluate the existing structure's potential for progressive collapse. If the existing building does not meet the progressive collapse requirements and mitigation measures are recommended, the Government shall be provided with all pertinent information to make an informed risk-based decision regarding the mitigation or the acceptance of risk, including a complete understanding of the potential consequences, and the cost associated with the recommended mitigation measure.

### 2.3 FACILITY SECURITY LEVELS (FSL)

In accordance with the ISC Risk Management Process [26], the application of progressive collapse design is dependent on the required level of protection as determined by the number of stories and FSL, or where a FSL has not yet been determined, by a facility-specific risk assessment or facility-specific requirements as provided in the Request for Proposal (RFP) or Program of Requirements (POR).

The ISC Risk Management Process [26] defines the criteria and process for determining the FSL of a Federal facility, which categorizes facilities based on the analysis of several security-related facility factors, including its target attractiveness, as well as its value or criticality. The responsibility for making the final FSL determination, specifically as it relates to incorporation of the requirements of these



Guidelines, rests with the Government, who must either accept the risk or fund security measures to reduce the risk.

Once a facility's FSL level has been established the applicability of these Guidelines is determined based on the Applicability flow chart and this section.

### 2.3.1 FSL I & II

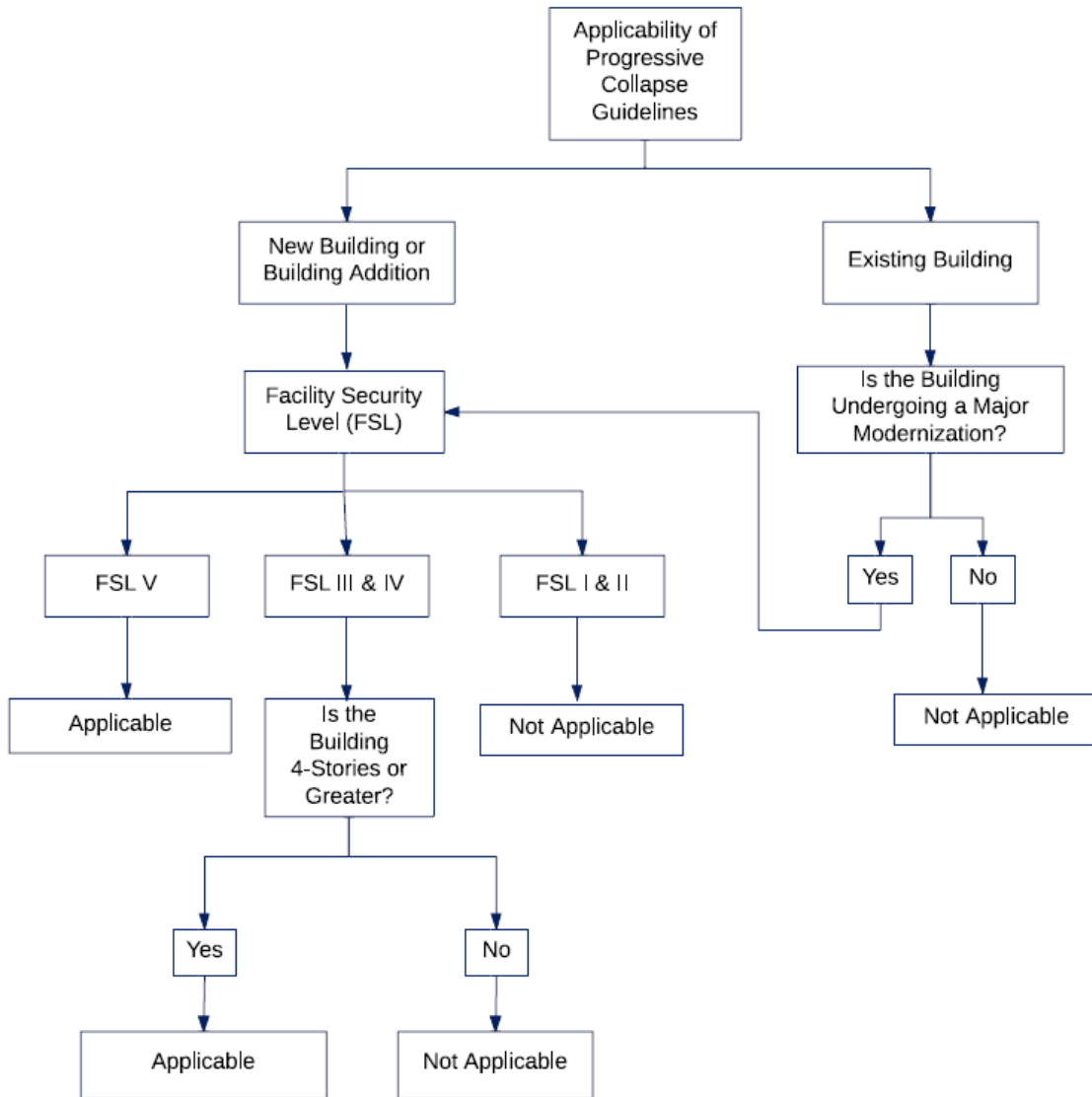
Given the low occupancy and risk level associated with these types of facilities, progressive collapse design is not required for FSL I and II, regardless of the number of floors.

### 2.3.2 FSL III & IV

These Guidelines are applicable to FSL III and IV buildings with four stories or more measured from the lowest point of exterior grade to the highest point of elevation. Unoccupied floors such as mechanical penthouses or parking shall not be considered a story. FSL III and IV facilities shall implement both the Alternate Path and Redundancy design procedures. The Alternate Path method shall be applied based on vertical load bearing element removal locations identified in Section 3.2.9.

### 2.3.3 FSL V

These Guidelines are applicable to all FSL V buildings regardless of number of floors. FSL V facilities shall implement the Alternate Path method based on vertical load bearing element removal locations identified in Section 3.2.9. Redundancy design procedures do not need to be applied to FSL V facilities.



**Figure 2.1. Applicability Flow Chart**



## 3 DESIGN PROCEDURES

These Guidelines employ the Alternate Path (AP) method only.

### 3.1 ~~TIE FORCES~~

This UFC section is removed in its entirety, including the following figures:

~~Figure 3.1.~~

~~Figure 3.2.~~

~~Figure 3.3.~~

~~Figure 3.4.~~

~~Figure 3.5.~~

~~Figure 3.6.~~

### 3.2 ALTERNATE PATH METHOD

The Alternate Path method is used to satisfy the progressive collapse requirements of this document for the removal of specific vertical load-bearing elements that are prescribed in Section 3.2.9.

#### 3.2.1 GENERAL

This method follows the general LRFD philosophy by employing a modified version of the ASCE 7 [9] load factor combination for extraordinary events and resistance factors to define design strengths. Three analysis procedures are employed: Linear Static (LSP), Nonlinear Static (NSP) and Nonlinear Dynamic (NDP). These procedures follow the general approach in ASCE 41 [10] with modifications to accommodate the particular issues associated with progressive collapse. Much of the material-specific criteria from Chapters 9 to 12 of ASCE 41 [10] are explicitly adopted in Chapters 4 to 8 of this document. The topics of each ASCE 41 [10] Chapter are:

- Steel or cast iron, ASCE 41 [10] Chapter 9
- Reinforced concrete, ASCE 41 [10] Chapter 10
- Reinforced or un-reinforced masonry, ASCE 41 [10] Chapter 11
- Timber, light metal studs, gypsum, or plaster products, ASCE 41 [10] Chapter 12

Note that some of the deformation and strength criteria in ASCE 41 [10] Chapters 9 to 12 have been superseded by requirements that are specified in the material specific Chapters 4 to 8.

#### 3.2.2 ALTERNATIVE RATIONAL ANALYSIS

For the performance of the Alternate Path analysis and design, nothing in this document shall be interpreted as preventing the use of any alternative analysis procedure that is rational and based on fundamental principles of engineering mechanics and dynamics. For example, simplified analytical methods employing hand calculations or spreadsheets may be appropriate and more efficient for some types of buildings, such as load-bearing wall structures.



The results of any alternative rational analyses shall meet the acceptance criteria contained in Section 3.2.10 and in Chapters 4 through 8. The analyses shall include the specified locations for removal of columns and load-bearing walls in Section 3.2.9 and the modified ASCE 7 [9] extreme event load combination, with the load increase factors in Sections 3.2.11.5 and 3.2.12.5 for linear static and nonlinear static analyses, respectively. The designer shall verify that these criteria are applicable to the alternative rational analyses. If a Linear Static approach is employed, the requirements of Section 3.2.11.1 must be met.

All projects using alternative rational analysis procedures shall be reviewed and approved by an independent third-party engineer or by an authorized representative of the Government. In addition, the proposed alternative rational analysis methodology shall be submitted to the Government for review and approval prior to commencement of work.

### 3.2.3 LOAD AND RESISTANCE FACTOR DESIGN FOR ALTERNATE PATH METHOD

The Alternate Path method employed in this document follows the general philosophy of the standard LRFD approach but with modifications to facilitate the integration of the ASCE 41 [10] procedures, which are not LRFD. For LRFD, the design strength is taken as the product of the strength reduction factor  $\phi$  and the nominal strength  $R_n$  calculated in accordance with the requirements and assumptions of applicable material specific codes. The design strength must be greater than or equal to the required strength:

$$\phi R_n \geq R_u \quad \text{Equation 3.1}$$

where  $\phi R_n$  = Design strength  
 $\phi$  = Strength reduction factor  
 $R_n$  = Nominal strength  
 $R_u = \sum \gamma_i Q_i$  = Required strength  
 $\gamma_i$  = Load factor  
 $Q_i$  = Load effect

Items to note relative to the integration of the LRFD and the ASCE 41 [10] approaches:

- While ASCE 41 [10] requires that all  $\phi$  factors be taken as unity, this document requires that strength reduction factors,  $\phi$ , be used as specified in the appropriate material specific code, for the action or limit state under consideration.
- ASCE 41 [10] uses the term "action" in the way LRFD defines "required strength". ASCE 41 [10] further differentiates actions into "deformation-controlled" and "force-controlled". These terms are defined later.
- In this document, the LRFD "nominal strength" is defined as either the "expected strength" when deformation-controlled actions are being considered or the "lower-bound strength" for force-controlled actions; ASCE 41 [10] sets all  $\phi$  factors to 1 and therefore, the expected and lower-bound strengths are the nominal strengths in this document.
- This document and ASCE 41 [10] both employ the same "over-strength factors" to translate lower bound material properties to expected strength material properties. The over-strength factors are provided in ASCE 41 [10] Tables 9-3 (structural steel), 10-1 (reinforced concrete), and



11-1 (masonry). For wood and cold-formed steel, Chapter 12 of ASCE 41 [10] provides default expected strength values; note that for wood construction, a time effect factor  $\lambda$  is also included.

Note that live load reductions (LLRs) per ASCE 7 [9] are permitted for all live loads used in Alternate Path analysis and design. For framed structures, where the floor slab is supported by beams and girders, the analyst may use the LLR for each beam individually or may use the same LLR for the entire structure. In the latter case, the LLR shall be equal to the smallest LLR (greatest live load) for any beam in the bays above the column removal location. For flat-slab structures, load-bearing wall structures and other situations where the floor system transfers loads directly to the columns or walls, the LLR shall be computed for, and applied to, the floor in each bay.

In all cases, the LLRs shall be based on the structural configuration before the column or load-bearing wall section is removed.

### 3.2.4 PRIMARY AND SECONDARY COMPONENTS

Designate all structural elements and components as either primary or secondary. Classify structural elements and components that provide the capacity of the structure to resist collapse due to removal of a vertical load-bearing element as primary. Classify all other elements and components as secondary. For example, a steel gravity beam may be classified as secondary if it is assumed to be pinned at both ends to girders and the designer chooses to ignore any flexural strength at the connection; if the connection is modeled as partially restrained and thus contributes to the resistance of collapse, it is a primary member.

### 3.2.5 FORCE-AND DEFORMATION-CONTROLLED ACTIONS

Classify all actions as either deformation-controlled or force-controlled using the component force versus deformation curve shown in Figure 3.7 and outlined below. Examples of deformation- and force-controlled actions are listed in Table 1. Note that a component might have both force- and deformation-controlled actions. Further, classification as a force- or deformation-controlled action is not up to the discretion of the user and must follow the guidance presented here.

In accordance with Figure 3.7, define a primary component action as deformation-controlled if it has a Type 1 curve and  $e \geq 2g$ , or, if it has a Type 2 curve and  $e \geq 2g$ . Define a primary component action as force-controlled if it has a Type 1 or Type 2 curve and  $e < 2g$ , or, if it has a Type 3 curve.

In accordance with Figure 3.7, define a secondary component action as deformation-controlled if it has a Type 1 curve for any  $e/g$  ratio or if it has a Type 2 curve and  $e \geq 2g$ . Define a secondary component action as force controlled if it has a Type 2 curve and  $e < 2g$ , or, if it has a Type 3 curve.

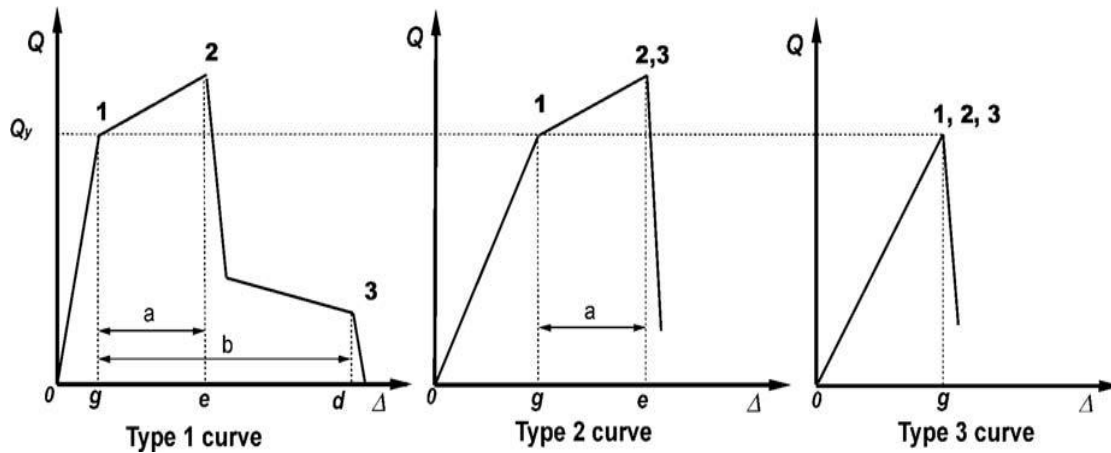


Figure 3.7. Definition of Force-Controlled and Deformation-Controlled Actions, from ASCE 41 [10]

Table 1. Examples of Deformation-Controlled and Force-Controlled Actions from ASCE 41 [10]

Component	Deformation-Controlled Action	Force- Controlled Action
Moment Frames <ul style="list-style-type: none"> <li>• Beams</li> <li>• Columns</li> <li>• Joints</li> </ul>	Moment (M) M --	Shear (V) Axial load (P), V $V^1$
Shear Walls	M, V	P
Braced Frames <ul style="list-style-type: none"> <li>• Braces</li> <li>• Beams</li> <li>• Columns</li> <li>• Shear Link</li> </ul>	P -- -- V	-- P P P, M
Connections	P, V, $M^2$	P, V, M

1. Shear may be a deformation-controlled action in steel moment frame construction.
2. Axial, shear, and moment may be deformation-controlled actions for certain steel and wood connections.

### 3.2.6 EXPECTED AND LOWER BOUND STRENGTH

When evaluating the behavior of deformation-controlled actions, use the expected strength,  $Q_{CE}$ .  $Q_{CE}$  is defined as the statistical mean value of the strength,  $Q$  (yield, tensile, compressive, etc., as appropriate), for a population of similar components, and includes consideration of the variability in material strengths as well as strain hardening and plastic section development. Note that  $Q_{CE}$  relates to any deformation-controlled action presented in Table 1, e.g., the expected strength for the moment in a deformation-controlled, laterally-braced beam would be  $Q_{CE} = M_{CE} = Z F_{YE}$ , where  $Z$  is the plastic section modulus and  $F_{YE}$  is the expected yield strength. If a database to determine  $F_{YE}$  is not available,  $F_{YE}$  is obtained by multiplying the lower-bound strength  $F_{YL}$  (the nominal strength or strength specified in the construction documents) by the appropriate factor from Chapters 9 to 12 in ASCE 41 [10], as discussed in Paragraph 3.2.7.

When evaluating the behavior of force-controlled actions, use a lower bound estimate of the component strength,  $Q_{CL}$ .  $Q_{CL}$  is defined as the statistical mean minus one standard deviation of the strength,  $Q$  (yield, tensile, compressive, etc., as appropriate), for a population of similar components. Note that  $Q_{CL}$  relates



to any force-controlled action presented in Table 1, e.g., the lower bound strength of a steel column under axial compression would be  $Q_{cl} = P_{cl}$ , where  $P_{cl}$  is based on the lowest value obtained for the limit states of column buckling, local flange buckling, or local web buckling, calculated with the lower bound strength,  $F_{yl}$ . Where data to determine the lower bound strength are not available, use the nominal strength or strength specified in the construction documents.

### 3.2.7 MATERIAL PROPERTIES

Expected material properties such as yield strength, ultimate strength, weld strength, fracture toughness, elongation, etc., shall be based on mean values of tested material properties. Lower bound material properties shall be based on mean values of tested material properties minus one standard deviation.

If data to determine the lower bound and expected material properties do not exist, use nominal material properties, or properties specified in construction documents, as the lower bound material properties unless otherwise specified in Chapters 9 through 12 of ASCE 41 [10]. Calculate the corresponding expected material properties by multiplying lower bound values by appropriate factors specified in Chapters 9 through 12 of ASCE 41 [10] to translate from lower bound material properties to expected material values. If factors for converting from a lower bound to expected material property are not specified, use the lower bound material property as the expected material property.

### 3.2.8 COMPONENT FORCE AND DEFORMATION CAPACITIES

Methods for calculation of individual component strengths and deformation capacities shall comply with the requirements in the individual ASCE 41 [10] material chapters.

As shown in the acceptance criteria given in Sections 3.2.11.7, 3.2.12.7 and 3.2.13.6, the expected and lower-bound strengths shall be multiplied by the strength reduction factors that are specified in the material specific design codes (i.e., the  $\phi$  factors in ACI 318 [3], the AISC *Manual of Steel Construction, Load and Resistance Factor Design* [21], etc.). Note that  $\phi$  factors are taken as 1.0 in ASCE 41 [10].

#### 3.2.8.1 COMPONENT CAPACITIES FOR NONLINEAR PROCEDURES

For nonlinear procedures, component capacities for deformation-controlled actions shall be taken as permissible inelastic deformation limits, and component capacities for force-controlled actions shall be taken as lower-bound strengths,  $Q_{cl}$ , multiplied by the appropriate strength reduction factor  $\phi$ , as summarized in Table 2.

**Table 2. Calculation of Component Capacities for Nonlinear Static and Nonlinear Dynamic Procedures**

Parameter	Deformation-Controlled	Force-Controlled
Deformation Capacity	Deformation limit	N/A
Strength Capacity	N/A	$\phi Q_{cl}$

#### 3.2.8.2 COMPONENT CAPACITIES FOR THE LINEAR STATIC PROCEDURE

For the linear static procedure, component capacities for deformation-controlled actions shall be defined as the product of *m-factors* and expected strengths,  $Q_{ce}$ , multiplied by the appropriate strength reduction



factor  $\phi$ . Capacities for force-controlled actions shall be defined as lower-bound strengths,  $Q_{cl}$ , multiplied by the appropriate strength reduction factor  $\phi$ , as summarized in Table 3.

**Table 3. Calculation of Component Capacities for the Linear Static Procedure**

Parameter	Deformation-Controlled	Force-Controlled
Material Strength	Expected Material Strength	Lower Bound Strength
Strength Capacity	$\phi m Q_{CE}$	$\phi Q_{CL}$

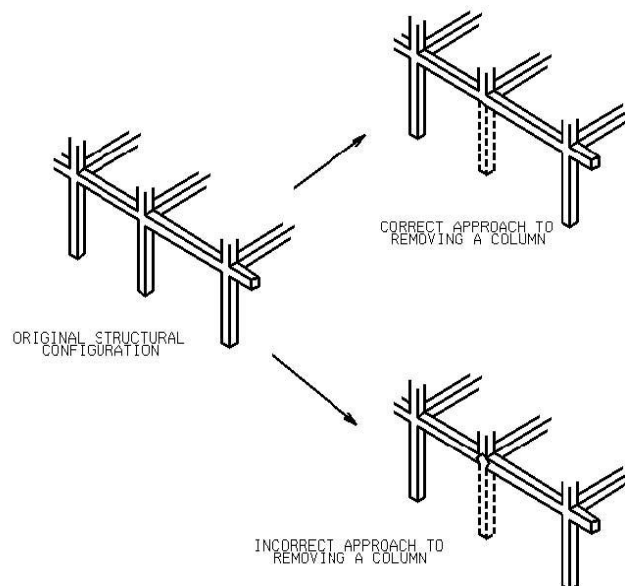
### 3.2.9 REMOVAL OF LOAD-BEARING ELEMENTS FOR THE ALTERNATE PATH METHOD

Vertical load-bearing elements are removed as identified below for each FSL Level.

- (1) For FSL III and IV, exterior elements at the first floor above grade and all elements (interior and exterior) within underground parking, loading docks, and areas of uncontrolled public access. For the purposes of these Guidelines, areas with controlled public access are considered those that meet the Access Control requirements of the ISC Risk Management Process [26] as follows:
  - a) Badge identification (ID) systems for employee access with guard personnel for visual and physical inspection before entry.
  - b) X-ray and magnetometer screening for all visitors and their property.
- (2) For FSL V, interior and exterior elements at each floor level.

#### 3.2.9.1 EXTENT OF REMOVED LOAD-BEARING ELEMENTS

For each column and load-bearing wall, remove the clear height between lateral restraints. For the purposes of column removal, beam-to-beam continuity is assumed to be maintained across a removed column; see Figure 3.8.



**Figure 3.8. Removal of Column from Alternate Path Model**



#### 3.2.9.1.1 ~~OC II OPTION 1 (DEFICIENT VERTICAL TIE FORCE)~~

This section is removed in its entirety.

#### 3.2.9.1.2 ~~OC II OPTION 2, OC III, AND OC IV~~

This section is removed in its entirety.

### 3.2.9.2 LOCATION OF REMOVED LOAD-BEARING ELEMENTS

#### 3.2.9.2.1 ~~OC II OPTION 1 (DEFICIENT VERTICAL TIE FORCE)~~

This section is removed in its entirety.

#### 3.2.9.2.2 EXTERNAL COLUMNS

Remove external columns near the middle of the short side, near the middle of the long side, at the corner of the building, and adjacent to the corner of the building (i.e. penultimate) as shown in Figure 3.9.

Also remove columns at critical column locations, as determined by engineering judgment in accordance with the standard of practice. At a minimum, the critical locations shall include but not be limited to the following conditions, where:

- The plan geometry of the structure changes significantly, such as abrupt decrease in bay size or re-entrant corners
- The structure has any vertical load discontinuity (i.e. transfer conditions)
- Adjacent columns are lightly loaded
- Adjacent bays have different tributary sizes
- Members frame in at different orientations or elevations.

If any other column is within a horizontal distance of 30% of the largest dimension of the associated bay from the column removal location, it must be removed simultaneously.

#### 3.2.9.2.3 INTERNAL COLUMNS

For structures with underground parking or areas of uncontrolled public access, remove internal columns near the middle of the short side, near the middle of the long side and at the corner of the uncontrolled space, as shown in Figure 3.10. For each plan location, the AP analysis is only performed for the story with the parking or uncontrolled public area.

The removed column extends from the floor of the underground parking area or uncontrolled public floor area to the next floor (i.e., a one story height must be removed). Internal columns must also be removed at all other critical locations, as determined by engineering judgment in accordance with the standard of practice. At a minimum, the critical locations shall include but not be limited to the following conditions, where:

- The plan geometry of the structure changes significantly, such as abrupt decrease in bay size or re-entrant corners
- The structure has any vertical load discontinuity (i.e. transfer conditions)



- Adjacent columns are lightly loaded
- Adjacent bays have different tributary sizes
- Members frame in at different orientations or elevations.

If any other column is within a horizontal distance of 30% of the largest dimension of the associated bay from the column removal location, it must be simultaneously removed.

#### 3.2.9.2.4 EXTERNAL LOAD-BEARING WALLS

As a minimum, remove external load-bearing walls near the middle of the short side, near the middle of the long side and at the corner of the building, as shown in Figure 3.11. For external corners, where one or both of the intersecting walls is load-bearing, remove a length of wall equal to the clear story height  $H$  in each direction. Also remove load-bearing walls at critical locations, as determined by engineering judgment in accordance with the standard of practice. At a minimum, the critical locations shall include but not be limited to the following conditions, where:

- The plan geometry of the structure changes significantly, such as abrupt decrease in bay size or re-entrant corners
- The structure has any vertical load discontinuity (i.e. transfer conditions)
- Adjacent walls are lightly loaded
- Adjacent bays have different tributary sizes
- Members frame in at different orientations or elevations.

In addition, the designer must use engineering judgment to shift the location of the removed wall section by a maximum of the clear story height  $H$  if that creates a worst case scenario.

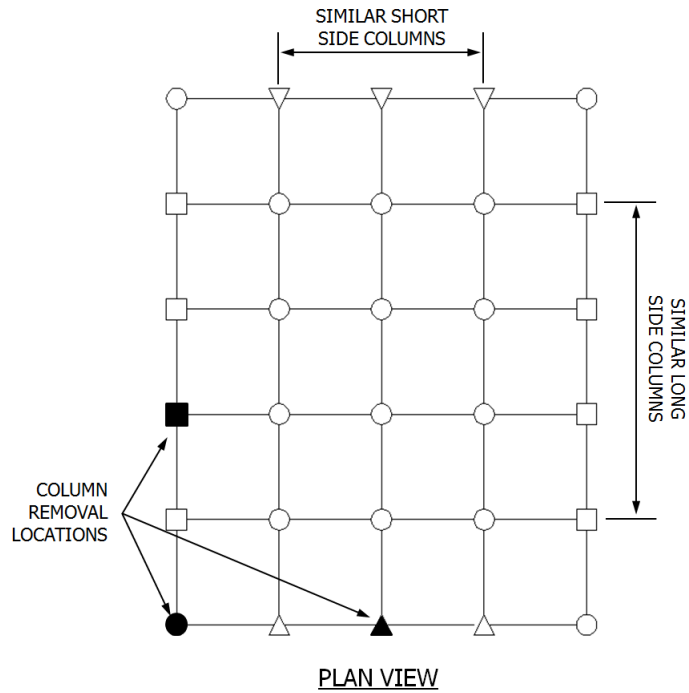
#### 3.2.9.2.5 INTERNAL LOAD-BEARING WALLS

For structures with underground parking or areas of uncontrolled public access, remove internal load-bearing walls near the middle of the short side, near the middle of the long side and at the corner of the uncontrolled space, as shown in Figure 3.12; see Section 3.2.9 for a definition of controlled public access.

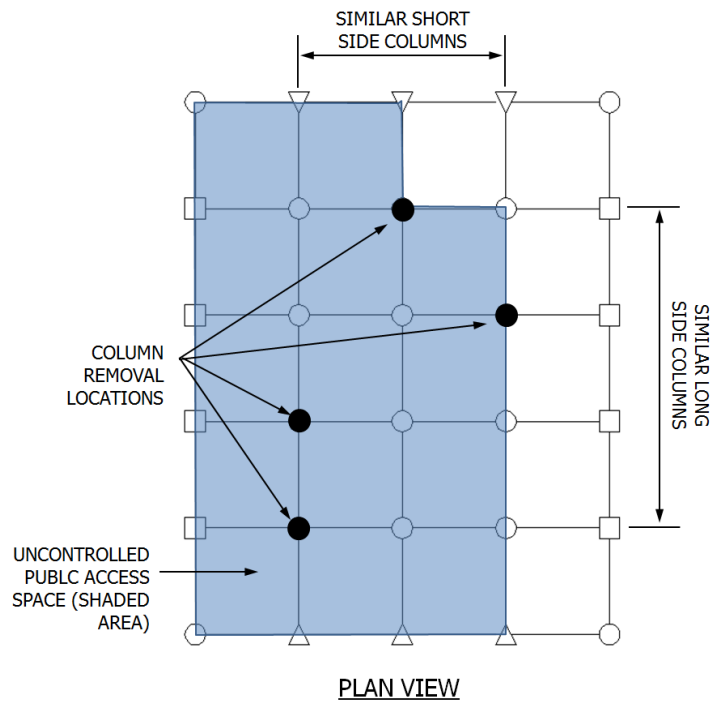
For internal corners, where one or both of the intersecting walls is load-bearing, remove a length of wall equal to the clear story height  $H$  in each direction. The removed wall extends from the floor of the underground parking area or uncontrolled public floor area to the next floor (i.e., a one story height must be removed). Also remove internal load-bearing walls at other critical locations within the uncontrolled public access area, as determined with engineering judgment. At a minimum, the critical locations shall include but not be limited to the following conditions, where:

- The plan geometry of the structure changes significantly, such as abrupt decrease in bay size or re-entrant corners
- The structure has any vertical load discontinuity (i.e. transfer conditions)
- Adjacent walls are lightly loaded
- Adjacent bays have different tributary sizes
- Members frame in at different orientations or elevations.

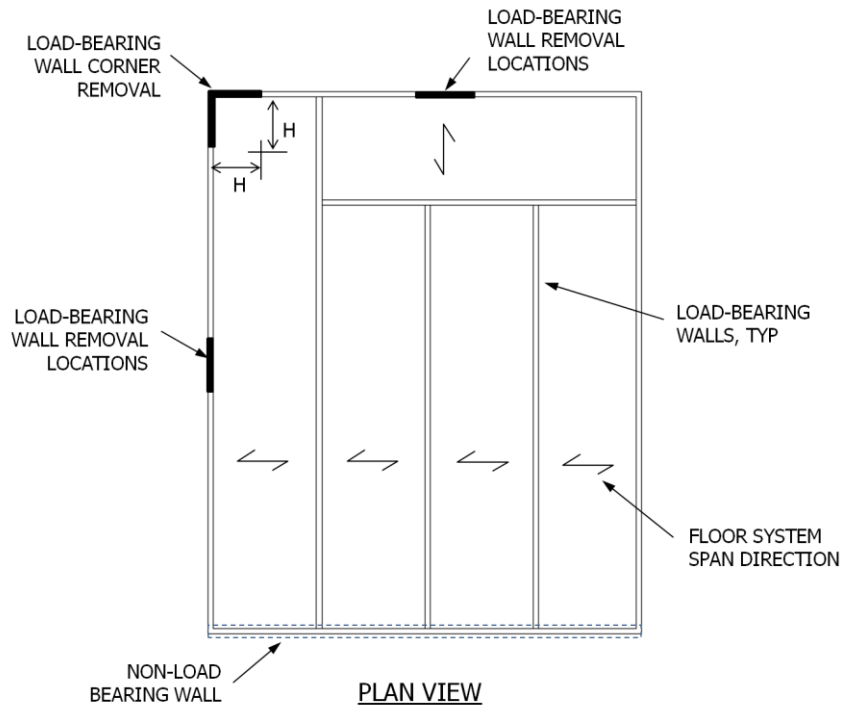
In addition, the designer must use engineering judgment to shift the location of the removed wall section by a maximum of the clear story height  $H$  if that creates a worst case scenario.



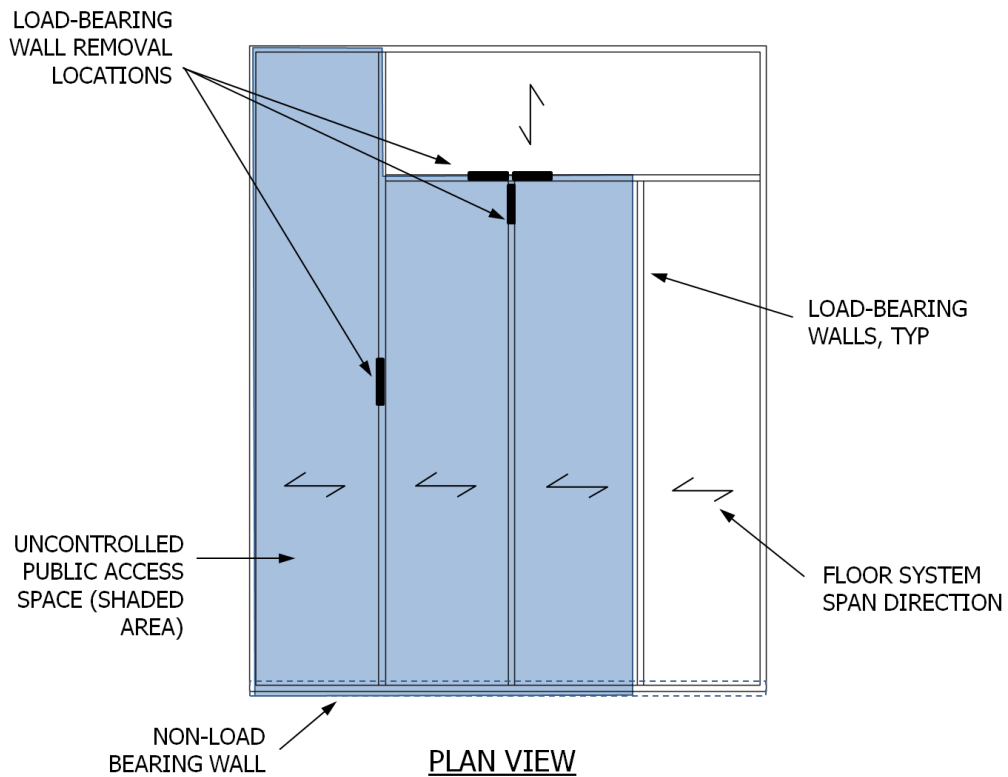
**Figure 3.9. Location of External Column Removal**



**Figure 3.10. Location of Internal Column Removal**



**Figure 3.11. Location of External Load-Bearing Wall Removal**



**Figure 3.12. Location of Internal Load-Bearing Wall Removal**



## 3.2.10 STRUCTURAL ACCEPTANCE CRITERIA

### 3.2.10.1 NEW BUILDINGS AND ADDITIONS

For all three analysis types (LSP, NSP, and NDP), a new building satisfies the Alternate Path requirements if none of the primary and secondary elements, components, or connections exceeds the acceptance criteria, in Paragraphs 3.2.11.7, 3.2.12.7, and 3.2.13.6, as appropriate. If the analysis predicts that any element, component, or connection does not meet these acceptance criteria, the building does not satisfy the Alternate Path requirements and must be re-designed to eliminate the non-conforming elements.

### 3.2.10.2 EXISTING BUILDINGS

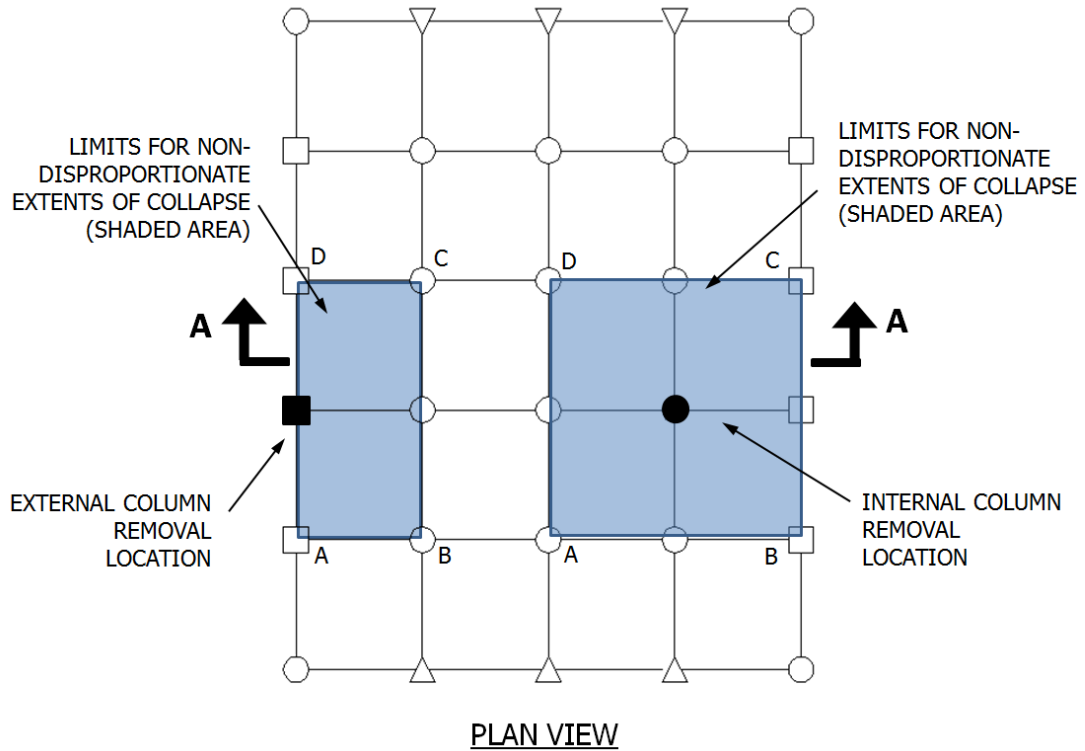
For all three analysis types (LSP, NSP, and NDP), an existing building satisfies the Alternate Path requirements if none of the primary and secondary elements, components, or connections exceeds the acceptance criteria, in Paragraphs 3.2.11.7, 3.2.12.7, and 3.2.13.6, as appropriate. Alternatively, if any primary or secondary elements, components, or connections exceed the acceptance criteria and additional analyses can be performed to demonstrate that the failure of these elements, components, or connections will not result in a disproportionate extent of collapse, as defined below, an existing building will be considered to satisfy the Alternate Path requirements. All projects using this alternative approach shall submit proposed methodology for approval by the Government prior to commencement of analysis. In addition, final analysis shall be approved by an independent third-party engineer or reviewed by an authorized representative of the Government in accordance with Section 3.2.2.

For the purposes of these guidelines, the extent of collapse is defined as the extent of the primary and secondary elements or their connections that exceeds the acceptance criteria, in Paragraphs 3.2.11.7, 3.2.12.7, and 3.2.13.6. A disproportionate extent of collapse resulting from the removal of a load bearing vertical element shall be defined as a collapsed area that exceeds the following:

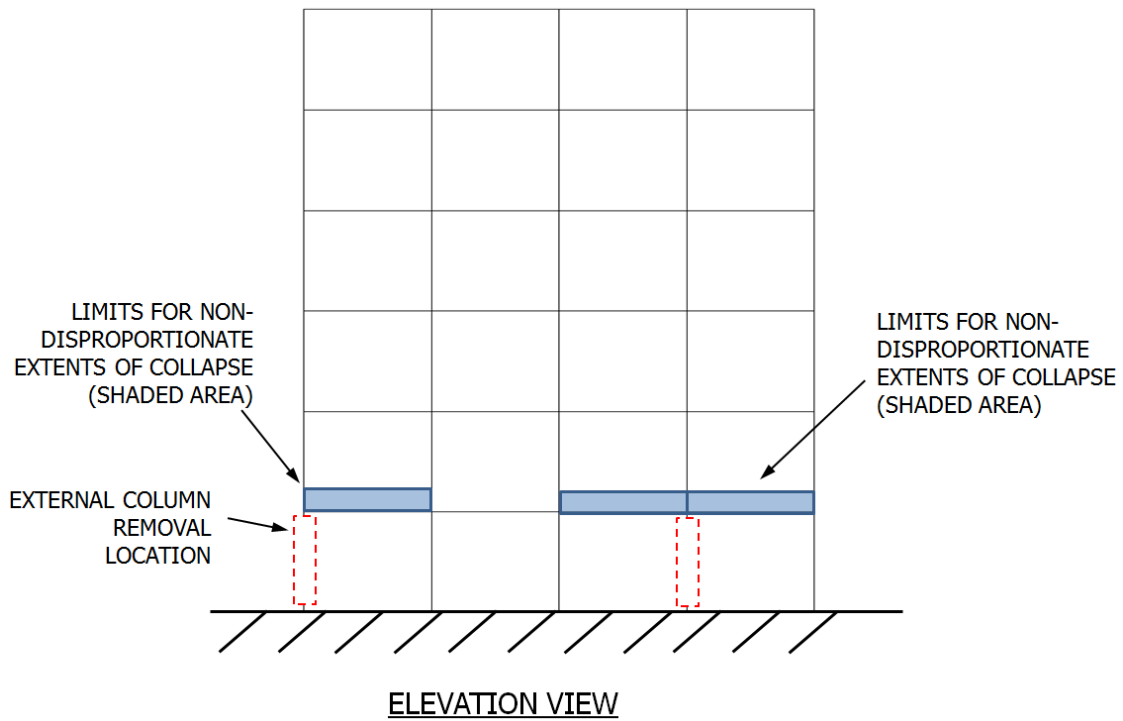
- (1) For exterior considerations, floor framing within a single structural bay on each side immediately adjacent to and at the floor level directly above the removed element, not to exceed 15% of the total floor area for each respective floor, as shown in Figure 3.13 and Figure 3.14.
- (2) For interior considerations, floor framing within a single structural bay on each side immediately adjacent to and at the floor level directly above the removed element, not to exceed 30% of the total floor area for each respective floor, as shown in Figure 3.13 and Figure 3.14..

Design of space below areas of collapse shall account for the effects of primary and secondary elements that may potentially fall and impact floor levels below. Alternatively, the designer shall demonstrate through any alternative rational analysis that elements will not disengage and fall into space below under the expected loads and displacements.

Where the existing building does not satisfy the Alternate Path requirements and mitigation measures are required, the Government shall be provided with all pertinent information to make an informed risk-based decision regarding the mitigation or the acceptance of risk, including a complete understanding of the potential consequences, and the cost associated with the recommended mitigation measure.



**Figure 3.13. Allowable Extents of Collapse for Interior and Exterior Column Removal in Plan**



**Figure 3.14. Allowable Extents of Collapse for Interior and Exterior Column Removal in Elevation**



### 3.2.11 LINEAR STATIC PROCEDURE

The LSP and limitations to its use are provided in the following sub-sections.

#### 3.2.11.1 LIMITATIONS ON THE USE OF LSP

The use of the LSP is limited to structures that are 10-stories or less and that meet the following requirements for irregularities and Demand-Capacity Ratios (DCRs).

If there are no structural irregularities as defined in Paragraph 3.2.11.1.1, a linear static procedure may be performed and it is not necessary to calculate the DCRs defined in Paragraph 3.2.11.1.2. If the structure is irregular, a linear static procedure may be performed if all of the component DCRs determined in Paragraph 3.2.11.1 are less than or equal to 2.0. If the structure is irregular and one or more of the DCRs exceed 2.0, then a linear static procedure cannot be used.

##### 3.2.11.1.1 IRREGULARITY LIMITATIONS

A structure is considered irregular if any one of the following is true:

1. Significant discontinuities exist in the gravity-load carrying and lateral force-resisting systems of a building, including out-of-plane offsets of primary vertical elements, roof "belt-girders", and transfer girders (i.e., non-stacking primary columns or load-bearing elements). Stepped back stories are not considered an irregularity.
2. At any exterior column except at the corners, at each story in a framed structure, the ratios of bay stiffness and/or strength from one side of the column to the other are less than 50%. Three examples are; a) the lengths of adjacent bays vary significantly, b) the beams on either side of the column vary significantly in depth and/or strength, and c) connection strength and/or stiffness vary significantly on either side of the column (e.g., for a steel frame building, a shear tab connection on one side of a column and a fully rigid connection on the other side shall be considered irregular).
3. For all external load-bearing walls, except at the corners, and for each story in a load-bearing wall structure, the ratios of wall stiffness and/or strength from one side of an intersecting wall to the other are less than 50%.
4. The horizontal lateral-load resisting elements are not parallel to the major orthogonal axes of the lateral force-resisting system, such as the case of skewed or curved moment frames and load-bearing walls.

##### 3.2.11.1.2 DCR LIMITATION

To calculate the DCRs for either framed or load-bearing structures, create a linear model of the building as described in Paragraph 3.2.11.2. The model will have all primary components with the exception of the removed wall or column. The deformation-controlled load case in Paragraph 3.2.11.4.1 shall be applied, with gravity dead and live loads increased by the load increase factor  $\Omega_{LD}$  in Paragraph 3.2.11.5. The resulting actions (internal forces and moments) are defined as  $Q_{UDLim}$ .





Use  $Q_{UDLim}$  to calculate the  $DCRs$  for the deformation controlled actions as:

$$DCR = Q_{UDLim}/Q_{CE} \quad \text{Equation 3.2}$$

where  $Q_{CE}$  = Expected strength of the component or element, as specified in Chapters 4 to 8.

### 3.2.11.2 ANALYTICAL MODELING

To model, analyze, and evaluate a building, employ a three-dimensional assembly of elements and components. Note that hand or spreadsheet calculations can be used, as allowed in Section 3.2.2 Alternative Rational Analysis.

#### 3.2.11.2.1 LOADS

Analyze the model with two separate load cases: 1) to calculate the deformation-controlled actions  $Q_{UD}$ , and 2) to calculate the force-controlled actions  $Q_{UF}$ . Apply the gravity loads to the model using the load cases for deformation-controlled actions and force-controlled actions defined in Paragraph 3.2.11.4.

#### 3.2.11.2.2 REQUIRED MODEL ELEMENTS

Include the stiffness and resistance of only the primary elements and components. Ensure that the model includes a sufficient amount of structural detail to allow the correct transfer of vertical loads from the floor and roof system to the primary elements. Use the guidance of ASCE 41 [10] Chapters 9 through 12 to create the model. After the analysis is performed, check the primary and secondary elements against the acceptance criteria for force-controlled and deformation-controlled actions.

While secondary elements are not included in the model, their actions and deformations can either be estimated based on the deformations of the model with only primary elements or the model may be re-analyzed with the secondary components included. If the model is re-analyzed with the secondary components included, their stiffness and resistance must be set to zero, i.e., the advantage of including the secondary elements is that the analyst may more easily check the secondary elements' deformations rather than perform hand calculations of the original model.

If the building contains sections that are three stories or less and are attached to the sections with four stories or greater, the designer shall perform an analysis to determine whether there is a possibility that the presence of the short section will affect the taller section in a negative manner; if so, then include the short section in the model.

#### 3.2.11.2.3 LIMITATIONS ON CONNECTION STRENGTH

For models that incorporate connections between horizontal flexural elements (beams, slabs, girders, etc.) and vertical load-bearing elements (columns and walls), the strength of the connection shall not be modeled as greater than the strength of the attached horizontal flexural element.

### 3.2.11.3 STABILITY/P-Δ EFFECTS

Note that overall vertical and lateral stability as well as local stability (i.e. lateral torsional buckling) must be considered. However, a P-Δ analysis is not required for the Linear Static approach due to the small deformations.



### 3.2.11.4 LOADING

Due to the different methods by which deformation-controlled and force-controlled actions are calculated, two load cases will be applied and analyzed: one for the deformation-controlled actions, and one for the force-controlled actions, as specified here.

Live load reduction is allowed, if the requirements in Section 3.2.3 are met.

#### 3.2.11.4.1 LOAD CASE FOR DEFORMATION-CONTROLLED ACTIONS $Q_{UD}$

To calculate the deformation-controlled actions, simultaneously apply the following combination of gravity loads:

Increased Gravity Loads for Floor Areas Above Removed Column or Wall. Apply the following increased gravity load combination to those bays immediately adjacent to the removed element and at all floors above the removed element as shown in Figure 3.15 and Figure 3.16.

$$G_{LD} = \Omega_{LD} [1.2 D + (0.5 L \text{ or } 0.2 S)] \quad \text{Equation 3.3}$$

where  $G_{LD}$  = Increased gravity loads for deformation-controlled actions for Linear Static analysis

$D$  = Dead load including façade loads ( $\text{lb/ft}^2$  or  $\text{kN/m}^2$ )

$L$  = Live load including live load reduction per Section 3-2.3, not to exceed the maximum of  $50\text{-lb/ft}^2$  or  $244\text{-kN/m}^2$

$S$  = Snow load ( $\text{lb/ft}^2$  or  $\text{kN/m}^2$ )

$\Omega_{LD}$  = Load increase factor for calculating deformation-controlled actions for Linear Static analysis; use appropriate value for framed or load-bearing wall structures; see Paragraph 3.2.11.5

Gravity Loads for Floor Areas Away From Removed Column or Wall. Apply the following gravity load combination to those bays not loaded with  $G_{LD}$  as shown in Figure 3.15 and Figure 3.16.

$$G = 1.2 D + (0.5 L \text{ or } 0.2 S) \quad \text{Equation 3.4}$$

where  $G$  = Gravity loads

#### 3.2.11.4.2 LOAD CASE FOR FORCE-CONTROLLED ACTIONS $Q_{UF}$

To calculate the force-controlled actions, simultaneously apply the following combination of gravity loads.

Increased Gravity Loads for Floor Areas Above Removed Column or Wall. Apply the following increased gravity load combination to those bays immediately adjacent to the removed element and at all floors above the removed element as shown in Figure 3.15 and Figure 3.16.

$$G_{LF} = \Omega_{LF} [1.2 D + (0.5 L \text{ or } 0.2 S)] \quad \text{Equation 3.5}$$



where  $G_{LF}$  = Increased gravity loads for force-controlled actions for Linear Static analysis

$D$  = Dead load including façade loads (lb/ft<sup>2</sup> or kN/m<sup>2</sup>)

$L$  = Live load including live load reduction per Section 3.2.3, not to exceed 50-lb/ft<sup>2</sup> or 244-kN/m<sup>2</sup>

$S$  = Snow load (lb/ft<sup>2</sup> or kN/m<sup>2</sup>)

$\Omega_{LF}$  = Load increase factor for calculating force-controlled actions for Linear Static analysis; use appropriate value for framed or load-bearing wall structures; see Section 3.2.11.5

Gravity Loads for Floor Areas Away From Removed Column or Wall. Use Equation 3.4 to determine the load  $G$  and apply as shown in Figure 3.15 and Figure 3.16.

### 3.2.11.5 LOAD INCREASE FACTOR

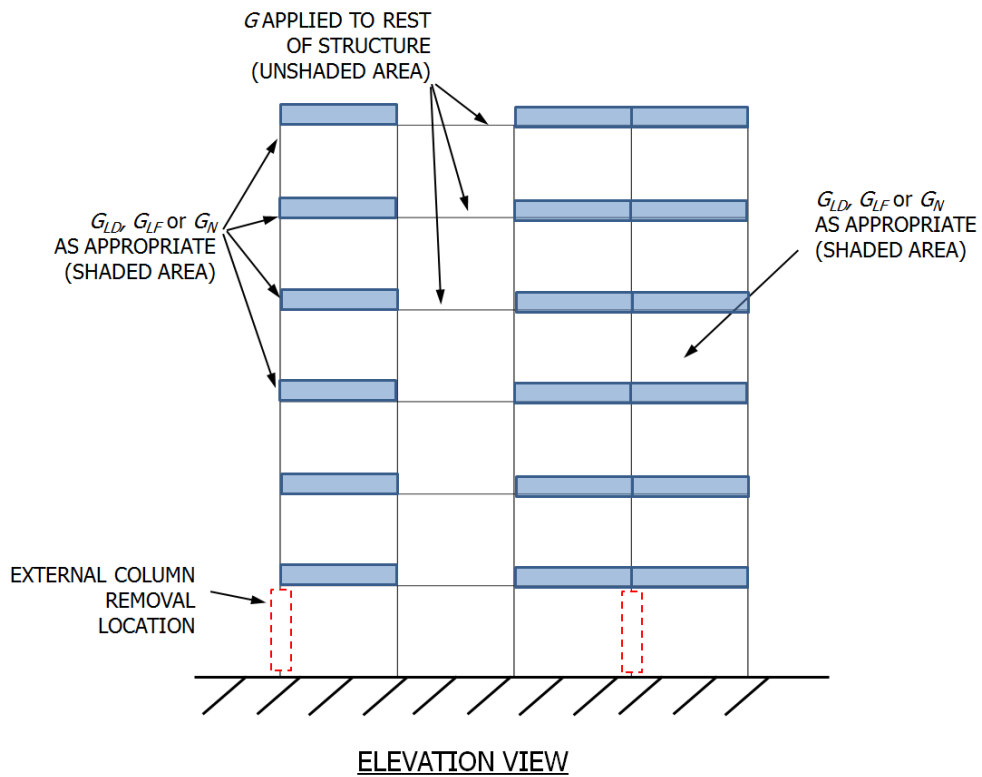
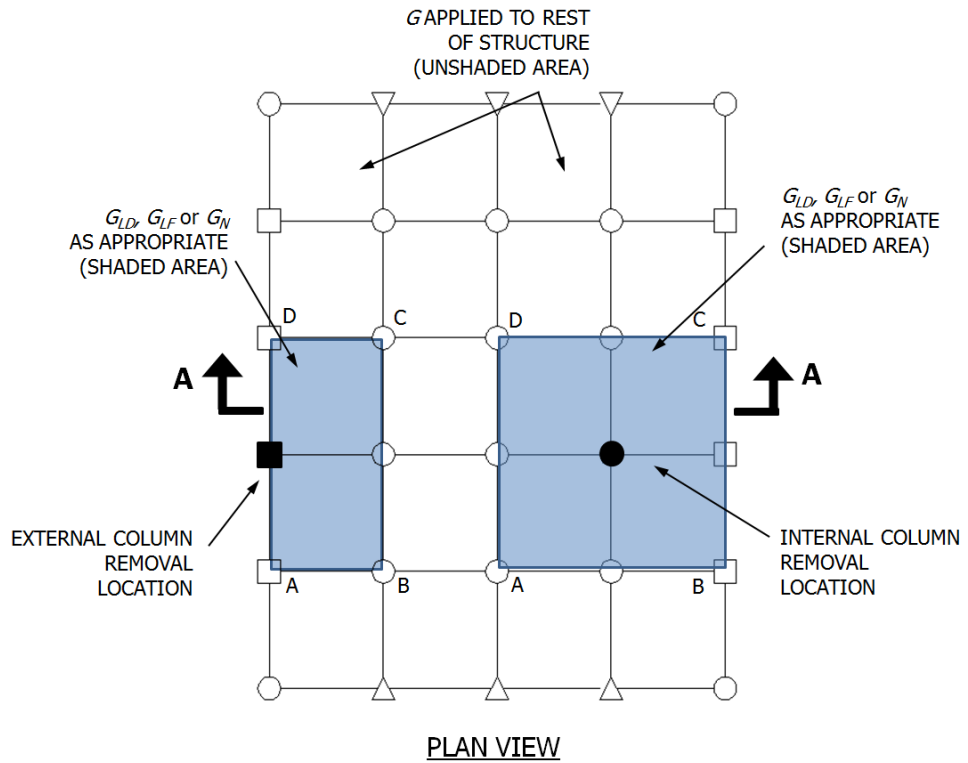
The load increase factors for deformation-controlled and force-controlled actions for column and wall removal are provided in Table 4

In Table 4,  $m_{LIF}$  is the smallest  $m$  of any primary beam, girder, spandrel or wall element that is directly connected to the columns or walls directly above the column or wall removal location. For each primary beam, girder, spandrel or wall element,  $m$  is the  $m$ -factor defined in Chapters 4 to 8 of this document, where  $m$  is either explicitly provided in each chapter or reference is made to ASCE 41 [10] and a corresponding performance level (Life Safety or Collapse Prevention). Columns are omitted from the determination of  $m_{LIF}$ . The method behind this procedure is explained in Appendix C.

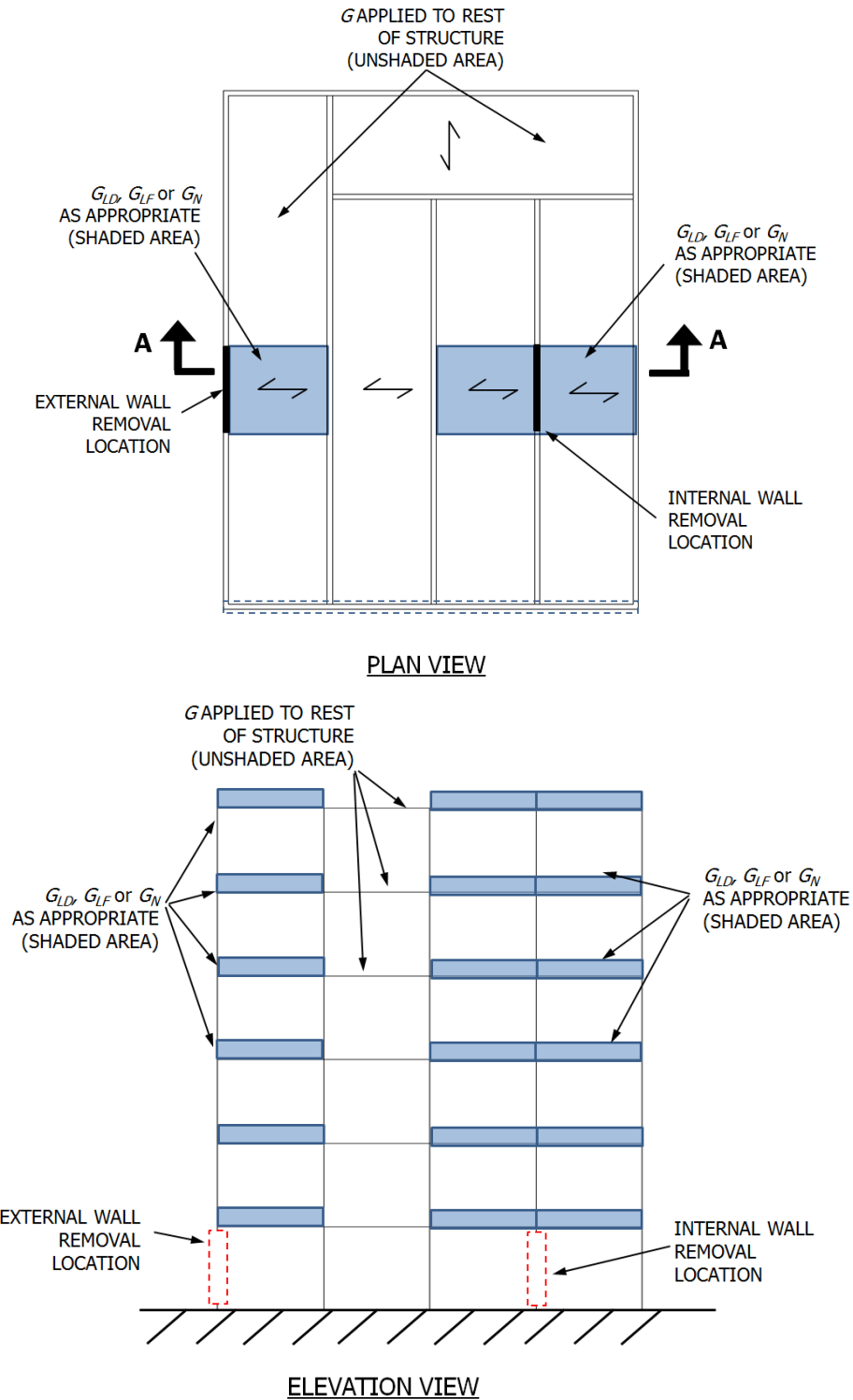
**Table 4. Load Increase Factors for Linear Static Analysis**

Material	Structure Type	$\Omega_{LD}$ , Deformation-controlled	$\Omega_{LF}$ , Force-controlled
Steel	Framed	$0.9 m_{LIF} + 1.1$	2.0
Reinforced Concrete	Framed <sup>A</sup>	$1.2 m_{LIF} + 0.80$	2.0
	Load-bearing Wall	$2.0 m_{LIF}$	2.0
Masonry	Load-bearing Wall	$2.0 m_{LIF}$	2.0
Wood	Load-bearing Wall	$2.0 m_{LIF}$	2.0
Cold-formed Steel	Load-bearing Wall	$2.0 m_{LIF}$	2.0

<sup>A</sup> Note that, per ASCE 41 [10], reinforced concrete beam-column joints are treated as force-controlled; however, the hinges that form in the beam near the column are deformation-controlled and the appropriate  $m$ -factor from Chapter 4 of this document shall be applied to the calculation of the deformation-controlled load increase factor  $\Omega_{LD}$ .



**Figure 3.15. Loads and Load Locations for External and Internal Column Removal for Linear and Nonlinear Static Models (Left Side Demonstrates External Column Removal; Right Side Shows Internal Column Removal)**



**Figure 3.16. Loads and Load Locations for External and Internal Wall Removal for Linear and Nonlinear Static Models (Left Side Demonstrates External Wall Removal; Right Side Shows Internal Wall Removal)**



### 3.2.11.6 DESIGN FORCES AND DEFORMATIONS

Calculate the deformation-controlled actions  $Q_{UD}$ , and force-controlled actions  $Q_{UF}$ , accordance with the linear analysis procedures of Sections 3.2.11.2 to 3.2.11.5.

### 3.2.11.7 COMPONENT AND ELEMENT ACCEPTANCE CRITERIA

Components and elements analyzed using the linear procedures of Sections 3.2.11.2 to 3.2.11.5 shall satisfy the requirements of this section. Prior to selecting component acceptance criteria, classify components as primary or secondary, and classify actions as deformation-controlled or force-controlled, as defined in Section 3.2.4 and 3.2.5.

#### 3.2.11.7.1 DEFORMATION-CONTROLLED ACTIONS.

For deformation-controlled actions in all primary and secondary components, check that:

$$\phi m Q_{CE} \geq Q_{UD} \quad \text{Equation 3.6}$$

where  $Q_{UD}$  = Deformation-controlled action, from Linear Static model

$m$  = Component or element demand modifier (m-factor) as defined in Chapters 4 to 8 of this document

$\phi$  = Strength reduction factor from the appropriate material specific code

$Q_{CE}$  = Expected strength of the component or element for deformation-controlled actions

$Q_{CE}$ , the expected strength, shall be determined by considering all coexisting actions on the component under the design loading condition by procedures specified in ASCE 41 [10] Chapters 9 through 12. Note that this includes interaction equations for shear, axial force, and moment and that these equations include force- and deformation-controlled actions, as well as expected and lower bound strengths.

Use the appropriate resistance factor for each action, as specified in the material specific design codes (i.e., the  $\Phi$  factors in ACI 318 [3], the AISC Manual of Steel Construction [21], etc.).

#### 3.2.11.7.2 FORCE-CONTROLLED ACTIONS

For force-controlled actions in all primary and secondary components,

$$\phi Q_{CL} \geq Q_{UF} \quad \text{Equation 3.7}$$

where  $Q_{UF}$  = Force-controlled action, from Linear Static model

$Q_{CL}$  = Lower-bound strength of a component or element for force-controlled actions

$\phi$  = Strength reduction factor from the appropriate material specific code

$Q_{CL}$ , the lower-bound strength, shall be determined by considering all coexisting actions on the component under the design loading condition by procedures specified in ASCE 41 [10] Chapters 9



through 12. Use the appropriate resistance factor for each action, as specified in the material specific design codes (i.e., the  $\phi$  factors in ACI 318 [3], the AISC Manual of Steel Construction [21], etc.).

### 3.2.11.7.3 SECONDARY ELEMENTS AND COMPONENTS

All secondary components and elements must be checked to ensure that they meet the acceptance criteria. Deformation-controlled actions are checked according to Equation 3.6 and force-controlled actions are checked according to Equation 3.7.

### 3.2.12 NONLINEAR STATIC PROCEDURE

The NSP and limitations to its use are provided in the following sub-sections.

#### 3.2.12.1 LIMITATIONS ON THE USE OF NSP

There are no DCR or geometric irregularity limitations on the use of the NSP.

#### 3.2.12.2 ANALYTICAL MODELING

To model, analyze, and evaluate a building, employ a three-dimensional assembly of elements and components. Create one model for either framed or load-bearing wall structures, respectively. Inclusion of secondary components in the model is optional. However, if the secondary components are omitted, they must be checked after the analysis, against the allowable deformation-controlled criteria (e.g., to check the connections of gravity beams in a steel structure, compute the chord rotation and compare against the allowable plastic rotation angle for that connection). Include the stiffness and resistance of primary components. Note that the strength reduction factors are applied to the nonlinear strength models of the deformation controlled components (e.g., the nominal flexural strength of a beam or connection is multiplied by the appropriate  $\phi$  factor). Analyze the model for the Nonlinear Static load case defined in Section 3.2.12.4.

Use the stiffness requirements of ASCE 41 [10] Chapters 9 through 12 to create the model. Discretize the load-deformation response of each component along its length to identify locations of inelastic action. The force-displacement behavior of all components shall be explicitly modeled, including strength degradation and residual strength, if any. Model a connection explicitly if the connection is weaker or has less ductility than the connected components, or the flexibility of the connection results in a change in the connection forces or deformations greater than 10%.

If the building contains sections that are less than four stories and are attached to the sections with four or more stories, the designer shall use engineering judgment to include some or all of the shorter section if there is any possibility that the presence of the short section will affect the taller section in a negative manner.

#### 3.2.12.3 STABILITY/P- $\Delta$ EFFECTS

Note that overall vertical and lateral stability as well as local stability (i.e., lateral torsional buckling) must be considered.



### 3.2.12.4 LOADING

Live load reduction is allowed, if the requirements in Section 3.2.3 are met.

#### 3.2.12.4.1 LOADS

To calculate the deformation-controlled and force-controlled actions, simultaneously apply the following combination of gravity loads:

Increased Gravity Loads for Floor Areas Above Removed Column or Wall. Apply the following increased gravity load combination to those bays immediately adjacent to the removed element and at all floors above the removed element as shown in Figure 3.15 and Figure 3.16.

$$G_N = \Omega_N [1.2 D + (0.5 L \text{ or } 0.2 S)] \quad \text{Equation 3.8}$$

where  $G_N$  = Increased gravity loads for Nonlinear Static Analysis

$D$  = Dead load including façade loads (lb/ft<sup>2</sup> or kN/m<sup>2</sup>)

$L$  = Live load including live load reduction per Section 3.2.3, not to exceed 50-lb/ft<sup>2</sup> or 244-kN/m<sup>2</sup>

$S$  = Snow load (lb/ft<sup>2</sup> or kN/m<sup>2</sup>)

$\Omega_N$  = Dynamic increase factor for calculating deformation-controlled and force-controlled actions for Nonlinear Static analysis; use appropriate value for framed or load-bearing wall structures; see Section 3.2.12.5.

Gravity Loads for Floor Areas Away From Removed Column or Wall. Apply the gravity load combination in Equation 3.9 to those bays not loaded with  $G_N$  as shown in Figure 3.15 and Figure 3.16.

$$G = 1.2 D + (0.5 L \text{ or } 0.2 S) \quad \text{Equation 3.9}$$

where  $G$  = Gravity loads

#### 3.2.12.4.2 LOADING PROCEDURE

Apply the loads using a load history that starts at zero and is increased to the final values. Apply at least 10 load steps to reach the total load. The software must be capable of incrementally increasing the load and iteratively reaching convergence before proceeding to the next load increment.

#### 3.2.12.5 DYNAMIC INCREASE FACTOR FOR NSP ( $\Omega_N$ )

The Nonlinear Static dynamic increase factors ( $\Omega_N$ ) are provided in Table 5. In Table 5,  $\theta_{pra}$  is the plastic rotation angle given in the acceptance criteria tables in ASCE 41 [10] and this document for the appropriate structural response level (Collapse Prevention or Life Safety), as specified in Chapters 4 to 8 of this document) for the particular element, component or connection;  $\theta_y$  is the yield rotation. For steel,  $\theta_y$  is given in Equation 9-1 in ASCE 41 [10]. For reinforced concrete,  $\theta_y$  is determined with the effective stiffness values provided in Table 10-5 in ASCE 41 [10]. Note that for connections,  $\theta_y$  is the yield rotation



angle of the structural element that is being connected (beam, slab, etc.) and  $\theta_{pra}$  is for the connection (determined from ASCE 41 [10] and this document). Columns are omitted from the determination of  $\Omega_N$ .

To determine  $\Omega_N$  for the analysis of the entire structure, choose the smallest ratio of  $\theta_{pra}/\theta_y$  for any primary element, component, or connection in the model within or touching the area that is loaded with the increased gravity load, as shown in Figure 3.15 and Figure 3.16.

In other words,  $\Omega_N$  for every primary connection, beam, girder, wall element, etc. that falls within or touches the perimeter marked as A-B-C-D in Figure 3.15 must be determined and the largest value is used for the analysis. The method behind this procedure is explained in Appendix C.

**Table 5. Dynamic Increase Factors ( $\Omega_N$ ) for Nonlinear Static Analysis**

Material	Structure Type	$\Omega_N$
Steel	Framed	$1.08 + 0.76/(\theta_{pra}/\theta_y + 0.83)$
Reinforced Concrete	Framed	$1.04 + 0.45/(\theta_{pra}/\theta_y + 0.48)$
	Load-Bearing Wall	2
Masonry	Load-bearing Wall	2
Wood	Load-bearing Wall	2
Cold-formed Steel	Load-bearing Wall	2

### 3.2.12.6 DESIGN FORCES AND DEFORMATIONS

Calculate component design forces and deformations in accordance with the nonlinear analysis procedure of Sections 3.2.12.2 to 3.2.12.5.

### 3.2.12.7 COMPONENT AND ELEMENT ACCEPTANCE CRITERIA

Components and elements analyzed using the nonlinear procedures of Sections 3.2.12.2 to 3.2.12.5 shall satisfy the requirements of this section.

#### 3.2.12.7.1 DEFORMATION-CONTROLLED ACTIONS

Primary and secondary elements and components shall have expected deformation capacities greater than the maximum calculated deformation demands. Expected deformation capacities shall be determined considering all coexisting forces and deformations in accordance with Chapters 4 to 8 of this document.

#### 3.2.12.7.2 FORCE-CONTROLLED ACTIONS

For force controlled actions in all primary and secondary elements and components,

$$\Phi Q_{CL} \geq Q_{UF} \quad \text{Equation 3.10}$$

where  $Q_{UF}$  = Force-controlled action, from Nonlinear Static model



$Q_{ci}$  = Lower-bound strength of a component or element for force-controlled actions

$\phi$  = Strength reduction factor from the appropriate material specific code.

$Q_{ci}$ , the lower-bound strength, shall be determined by considering all coexisting actions on the component under the design loading condition by procedures specified in ASCE 41 [10] Chapters 9 through 12. Use the appropriate resistance factor for each action, as specified in the material specific design codes (i.e., the  $\phi$  factors in ACI 318 [3], the AISC Manual of Steel Construction [21], etc.).

### 3.2.13 NONLINEAR DYNAMIC PROCEDURE

The NDP and limitations to its use are provided in the following sub-sections.

#### 3.2.13.1 Limitations on the Use of NDP

There are no DCR or geometric irregularity limitations on the use of the NDP.

#### 3.2.13.2 ANALYTICAL MODELING

To model, analyze, and evaluate a building, employ a three-dimensional assembly of elements and components. Create a model of the entire structure, including the wall section and column that are to be removed during the analysis. Include the stiffness and resistance of primary components. Note that the strength reduction factors are applied to the nonlinear strength models of the deformation controlled components (e.g., the nominal flexural strength of a beam or connection is multiplied by the appropriate  $\phi$  factor). Inclusion of secondary components in the model is optional. However, if the secondary components are omitted, they must be checked after the analysis, against the allowable deformation-controlled criteria (e.g., to check the connections of gravity beams in a steel structure, compute the chord rotation and compare against the allowable plastic rotation angle for that connection). Apply the loads per the loading procedure in Section 3.2.13.4.

Use the stiffness requirements of ASCE 41 [10] Chapters 9 through 12 to create the model. Discretize the load-deformation response of each component along its length to identify locations of inelastic action. The force-displacement behavior of all components shall be explicitly modeled, including strength degradation and residual strength, if any. Model a connection explicitly if the connection is weaker or has less ductility than the connected components, or the flexibility of the connection results in a change in the connection forces or deformations greater than 10%.

If the building contains sections that are less than four stories and are attached to the sections with four or more stories, the designer shall use engineering judgment to include some or all of the shorter section if there is any possibility that the presence of the short section will affect the taller section in a negative manner.

#### 3.2.13.3 LATERAL STABILITY AND P- $\Delta$ EFFECTS

Note that overall vertical and lateral stability as well as local stability (i.e., lateral torsional buckling) must be considered.



#### 3.2.13.4 LOADING

Live load reduction is allowed, if the requirements in Section 3.2.3 are met.

##### 3.2.13.4.1 LOADS

To calculate the deformation-controlled and force-controlled actions, apply the following gravity load per the loading procedure given in Paragraph 3.2.13.4.2.

Gravity Loads for Entire Structure. Apply the gravity load combination in Equation 3.11 to the entire structure.

$$G_{ND} = 1.2 D + (0.5 L \text{ or } 0.2 S) \quad \text{Equation 3.11}$$

where  $G_{ND}$  = Gravity loads for Nonlinear Dynamic Analysis

$D$  = Dead load including façade loads (lb/ft<sup>2</sup> or kN/m<sup>2</sup>)

$L$  = Live load including live load reduction per Section 3.2.3, not to exceed 50-lb/ft<sup>2</sup> or 244-kN/m<sup>2</sup>

$S$  = Snow load (lb/ft<sup>2</sup> or kN/m<sup>2</sup>)

##### 3.2.13.4.2 LOADING PROCEDURE

Starting at zero load, monotonically and proportionately increase the gravity loads to the entire model (i.e., the column or wall section have not been removed yet) until equilibrium is reached.

After equilibrium is reached for the framed and load-bearing wall structures, remove the column or wall section. While it is preferable to remove the column or wall section instantaneously, the duration for removal must be less than one tenth of the period associated with the structural response mode for the vertical motion of the bays above the removed column, as determined from the analytical model with the column or wall section removed. The duration of the analysis shall be until the maximum displacement is reached or one cycle of vertical motion occurs at the column or wall section removal location, whichever is greater.

##### 3.2.13.5 DESIGN FORCES AND DEFORMATIONS

Calculate component design forces and deformations in accordance with the nonlinear analysis procedure of Sections 3.2.13.2 to 3.2.13.4.

##### 3.2.13.6 COMPONENT AND ELEMENT ACCEPTANCE CRITERIA

Components and elements analyzed using the nonlinear procedures of Sections 3.2.13.2 to 3.2.13.4 shall satisfy the requirements of this section.



### 3.2.13.6.1 DEFORMATION-CONTROLLED ACTIONS

Primary and secondary elements and components shall have expected deformation capacities greater than the maximum calculated deformation demands. Expected deformation capacities shall be determined considering all coexisting forces and deformations in accordance with Chapters 4 to 8 of this document.

### 3.2.13.6.2 FORCE-CONTROLLED ACTIONS

For force-controlled actions in all primary and secondary components,

$$\phi Q_{CL} \geq Q_{UF} \quad \text{Equation 3.12}$$

where  $Q_{UF}$  = Force-controlled action, from Nonlinear Dynamic model

$Q_{CL}$  = Lower-bound strength of a component or element for force-controlled actions

$\phi$  = Strength reduction factor from the appropriate material specific code.

$Q_{CL}$ , the lower-bound strength, shall be determined by considering all coexisting actions on the component under the design loading condition by procedures specified in ASCE 41 [10] Chapters 9 through 12. Use the appropriate resistance factor for each action, as specified in the material specific design codes (i.e., the  $\phi$  factors in ACI 318 [3], the AISC Manual of Steel Construction [21], etc.).

## 3.3 ~~ENHANCED LOCAL RESISTANCE~~

This UFC section has been removed in its entirety.

## 3.4 REDUNDANCY REQUIREMENTS

### 3.4.1 GENERAL

The Redundancy Requirements outlined below shall be applied in conjunction with the Alternate Path requirements of Section 3.2. Incorporation of these requirements is to be in conjunction with all other structural design requirements, including those for lateral loading such as wind or seismic.

### 3.4.2 LOAD REDISTRIBUTION SYSTEMS

Load redistribution systems shall be provided at the exterior (perimeter) of the structure to meet the following design requirements. In general, a load redistribution system is defined as a structural system that has the capability to redistribute gravity loads to adjacent structural elements under the loss of a column or load-bearing wall.

#### 3.4.2.1 LOCATION REQUIREMENTS

The minimum number of load redistribution systems incorporated into the structural design shall be determined by Equation 3.13.

$$n \geq N/3$$

Equation 3.13

where  $n$  = Number of vertical load redistribution systems. Values of  $n$  shall be rounded up to the next integer (i.e. for  $N=10$ ,  $n= 3.33 = 4$ ).

$N$  = Total number of floors.

Spacing of load redistribution systems up the height of the building shall not exceed three floors.

### 3.4.2.2 STRENGTH REQUIREMENTS

For each exterior ground level column and/or wall plan removal location, the variation of the design strength of any load redistributing system shall be within +/- 30% of the average design strength of load redistributing systems up the height of the building, as defined by Equation 3.14. Interior column and/or wall plan removal scenarios need not be considered.

$$\left| \frac{Q_{R_i} - \overline{Q_R}}{\overline{Q_R}} \right| \leq 0.3$$

Equation 3.14

where  $Q_{R_i}$  = Design strength of a given load redistributing system at a single floor level associated with the exterior ground level column and/or wall plan removal location under consideration.

$\overline{Q_R}$  = Average design strength of load redistributing systems up the height of the building associated with the exterior ground level column and/or wall plan removal location under consideration.

The calculated design strength of a load redistributing system,  $Q_R$ , shall be determined by considering the expected strength of all horizontal members contributing to the redistribution of gravity loads, as defined by Equation 3.15. The extent of horizontal members included in the load redistributing system at a given plan location shall be limited to a single structural bay perpendicular to and in either direction of the removed vertical element, as shown in Figure 3.17. For load-bearing wall systems, the extent of horizontal members included in the load redistribution system shall be defined as the same extents as the removed on removal location under consideration (i.e. "H").

The calculated design strength of a given member,  $Q_C$ , shall consider all applicable actions on the component and its connections (i.e. flexure, shear, etc.) under vertical gravity loading conditions and shall be in accordance with all applicable material specific-codes. In addition, where applicable, the composite behavior of elements shall be considered.

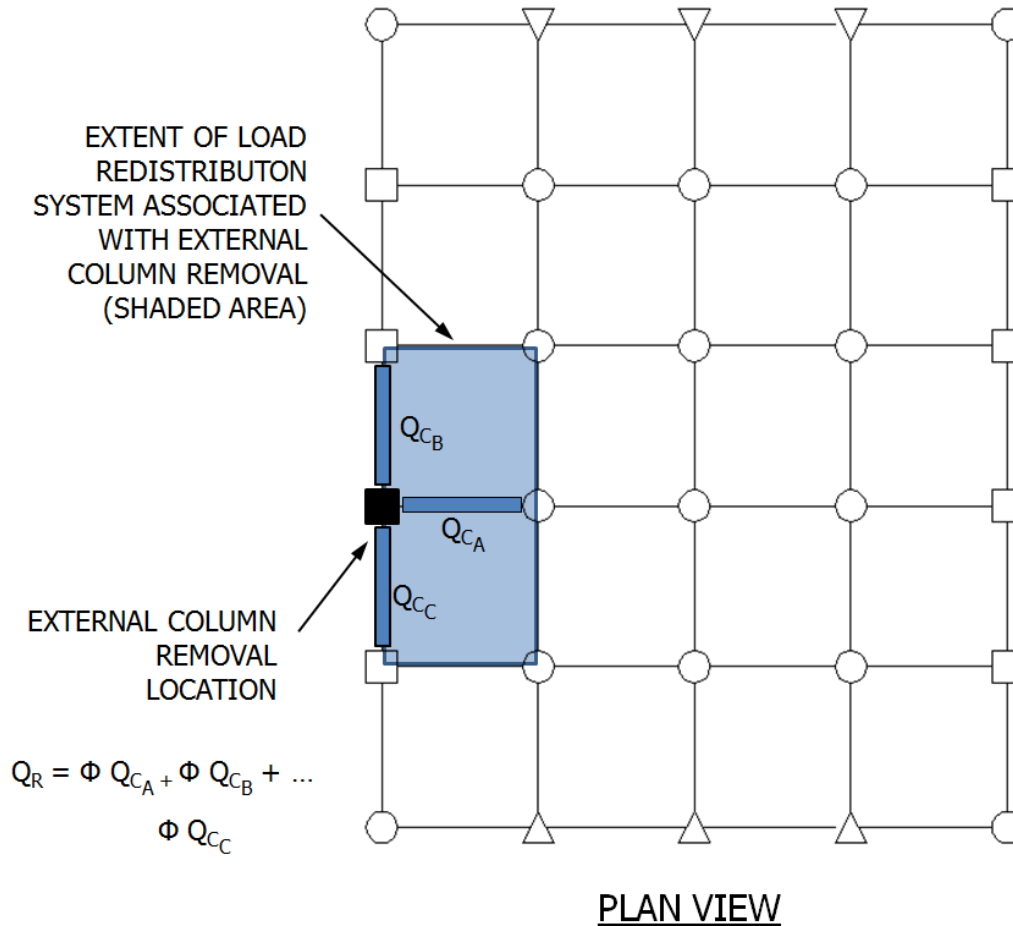
$$Q_R = \sum \phi Q_C$$

Equation 3.15

where  $Q_C$  = Design strength of a given load redistributing system at a single floor level associated with the exterior ground level column and/or wall plan removal location under consideration.

$Q_C$  = Expected strength of a component or element contributing to strength of a load redistributing system at a single floor level associated with the exterior ground level column and/or wall plan removal location under consideration.

$\phi$  = Strength reduction factor from the appropriate material specific code.



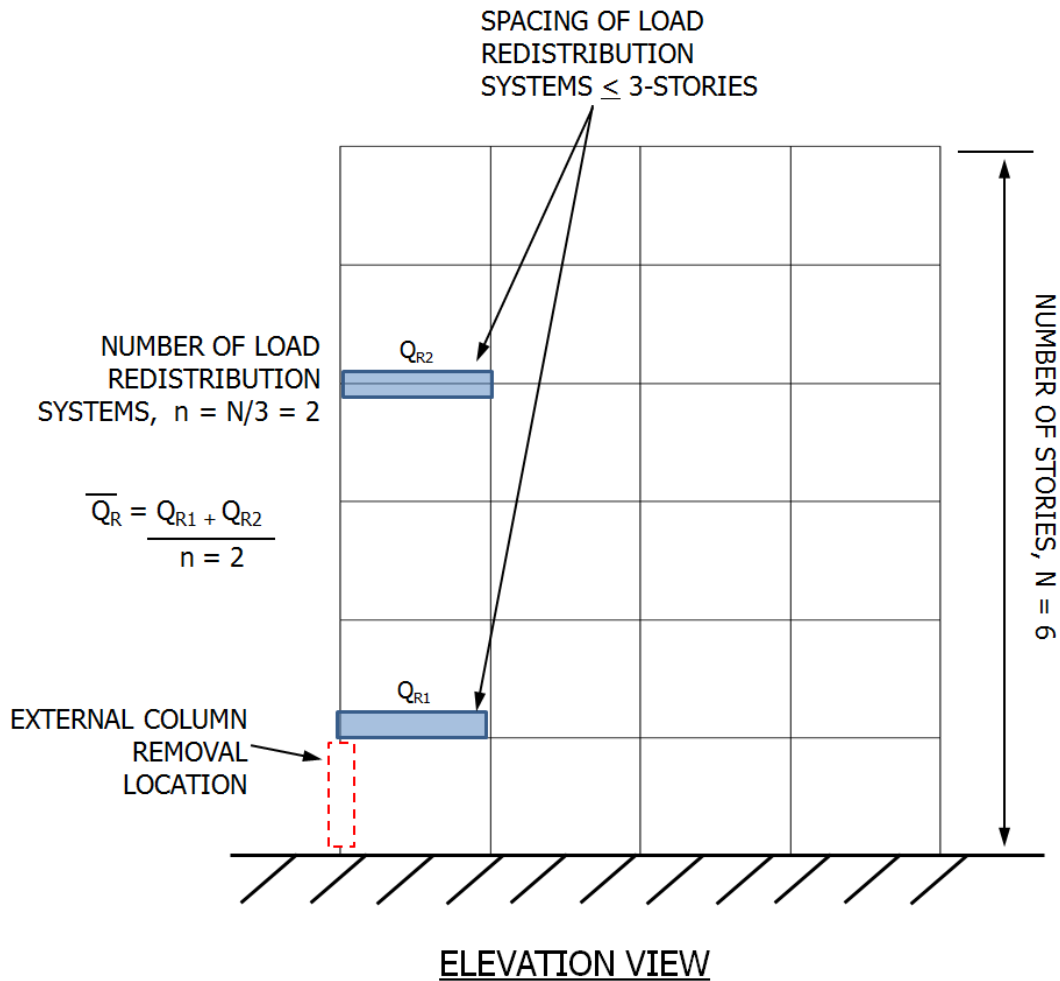
**Figure 3.17. Plan View of Strength Definitions for Load Redistributing Systems**

The average design strength shall consider all load redistribution systems up the height of the building, as shown in Figure 3.18 and Equation 3.16.

$$\bar{Q}_R = \frac{\sum_{i=1}^n Q_{Ri}}{n} \quad \text{Equation 3.16}$$

where  $Q_R$  = Design strength of a given load redistributing system at a single floor level associated with the exterior ground level column and/or wall plan removal location under consideration (Equation 3.15).

$n$  = Number of vertical load redistribution systems (Equation 3.13).



**Figure 3.18. Elevation View of Strength Definitions for Load Redistributing Systems**

### 3.4.2.3 STIFFNESS REQUIREMENTS

For each exterior ground level column and/or wall plan removal location, the variation of flexural stiffness of any load redistributing system shall be within +/- 30% of the average flexural stiffness of load redistributing systems up the height of the building, as defined by Equation 3.17. Interior column and/or wall plan removal scenarios need not be considered.

$$\left| \frac{K_{R_i} - \bar{K}_R}{\bar{K}_R} \right| \leq 0.3 \quad \text{Equation 3.17}$$

where  $K_{R_i}$  = Flexural stiffness of a given load redistributing system at a single floor level associated with the exterior ground level column and/or wall plan removal location under consideration.

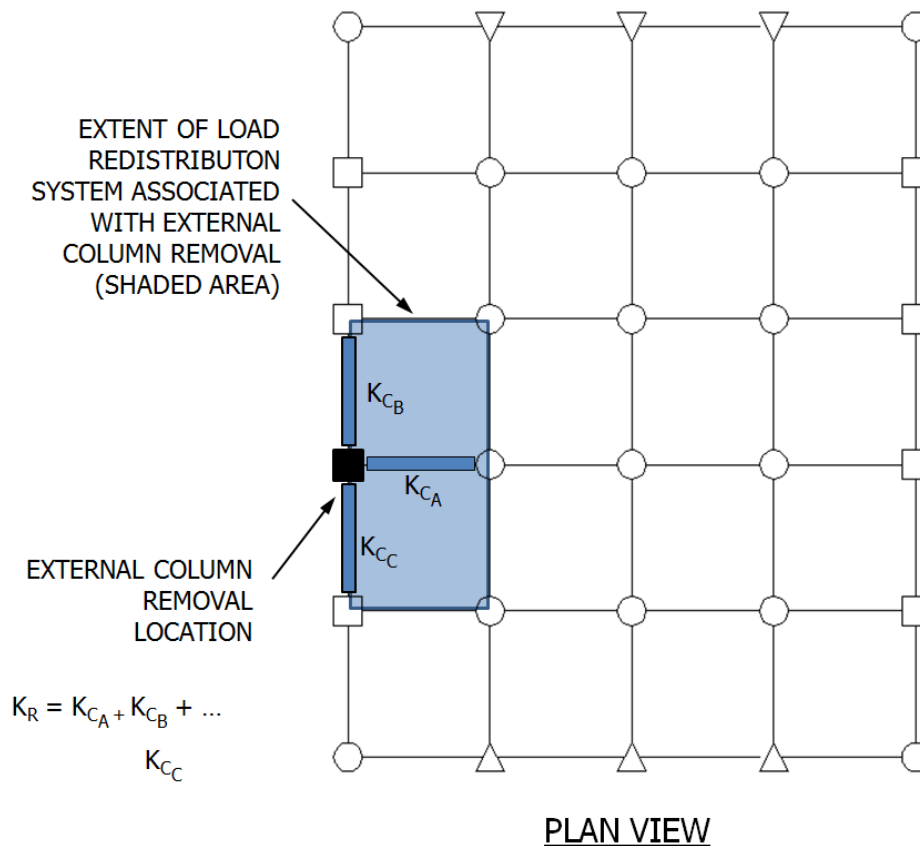
$\bar{K}_R$  = Average flexural stiffness of load redistributing systems up the height of the building associated with the exterior ground level column and/or wall plan removal location under consideration.

The calculated flexural stiffness of a load redistributing system,  $K_{R_i}$ , shall be determined by considering the expected flexural stiffness of all horizontal members contributing to the redistribution of gravity loads, as defined by Equation 3.18. The extent of horizontal members included in the load redistributing system at a given plan location shall be limited to a single structural bay perpendicular to and in either direction of the ground level column and/or wall plan removal location under consideration, as shown in Figure 3.19.

$$K_R = \sum \Phi K_C \quad \text{Equation 3.18}$$

where  $K_R$  = Flexural stiffness of a given load redistributing system at a single floor level associated with the exterior ground level column and/or wall plan removal location under consideration.

$K_C$  = Flexural stiffness of a component or element contributing to strength of a load redistributing system at a single floor level associated with the exterior ground level column and/or wall plan removal location under consideration.



**Figure 3.19. Plan View of Stiffness Definitions for Load Redistributing Systems**

The calculated flexural stiffness of a given member,  $K_C$ , shall be based on provided support conditions, prior to column or wall removal, and a uniformly distributed load. Example definition of the flexural stiffness for typical support conditions are shown in Figure 3.20 for reference.



	$K = \frac{384EI}{5L^3}$	(Pin-Pin)
	$K = \frac{185EI}{L^3}$	(Pin-Fix)
	$K = \frac{384EI}{L^3}$	(Fix-Fix)

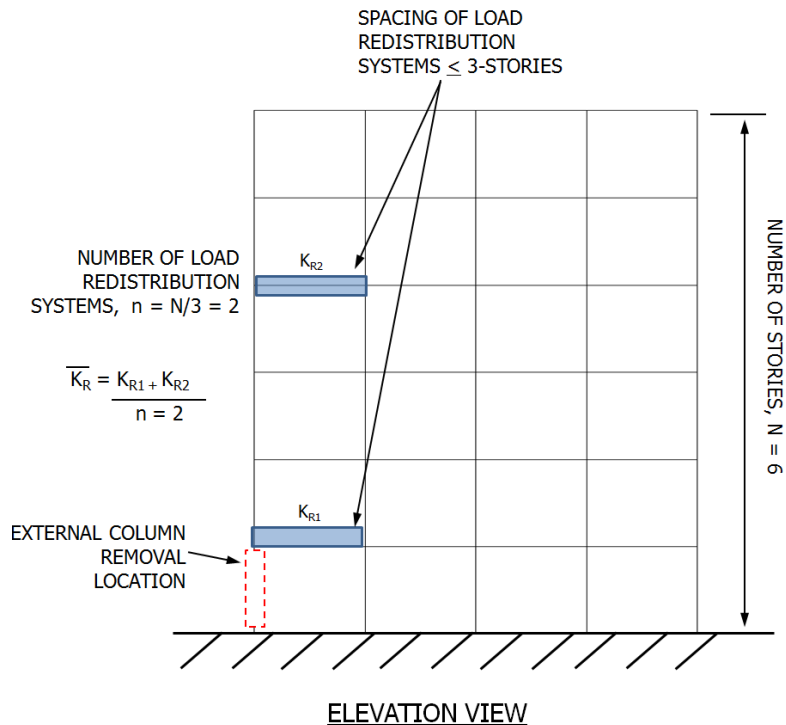
**Figure 3.20. Definition of Stiffness based on Various Support Conditions**

The average flexural stiffness shall consider all load redistribution systems up the height of the building, as shown in Figure 3.21 and Equation 3.19.

$$\overline{K}_R = \frac{\sum_{i=1}^n K_{Ri}}{n} \quad \text{Equation 3.19}$$

where  $K_R$  = Flexural stiffness of a given load redistributing system at a single floor level associated with the exterior ground level column and/or wall plan removal location under consideration (Equation 3.18).

$n$  = Number of vertical load redistribution systems (Equation 3.13).



**Figure 3.21. Elevation View of Stiffness Definitions for Load Redistributing Systems**



## 4 REINFORCED CONCRETE

Chapter 4 of the UFC 4-023-03 [31] is adopted with the following modifications:

1. Modeling and acceptance criteria for primary and secondary components have been revised from Life Safety to Collapse Prevention.
2. All references to Enhanced Local Resistance (ELR) and Tie Force analysis methods are removed.

This chapter provides the specific requirements for designing a reinforced concrete building to resist progressive collapse. Appendix D demonstrates the application of the reinforced concrete design requirements for an 8-story building.

If composite construction with other materials is employed, use the design guidance from the appropriate material chapter in this document for those structural elements or portions of the structure.

### 4.1 MATERIAL PROPERTIES FOR REINFORCED CONCRETE

Apply the appropriate over-strength factors to the calculation of the design strengths for the Alternate Path method. The over-strength factors are provided in ASCE 41 [10] in Table 10-1 Factors to Translate Lower-Bound Material Properties to Expected Strength Material Properties.

### 4.2 STRENGTH REDUCTION FACTOR $\phi$ FOR REINFORCED CONCRETE

For the Alternate Path methods, use the appropriate strength reduction factor specified in ACI 318 *Building Code Requirements for Structural Concrete* [3] for the component and behavior under consideration.

### 4.3 ~~TIE FORCE REQUIREMENTS FOR REINFORCED CONCRETE~~

This section is removed in its entirety.

### 4.4 ALTERNATE PATH REQUIREMENTS FOR REINFORCED CONCRETE

#### 4.4.1 GENERAL

Use the Alternate Path method in Section 3.2 to verify that the structure can meet the acceptance criteria defined in Section 3.2.10.

#### 4.4.2 FLEXURAL MEMBERS AND JOINTS

For new and existing construction, the design strength and rotational capacities of the beams and beam-to-column joints shall be determined with the guidance found in ASCE 41 [10], as modified with the acceptance criteria provided in Section 4.4.3.



#### 4.4.3 MODELING AND ACCEPTANCE CRITERIA FOR REINFORCED CONCRETE

With the exception of Tables 10-7, 10-13, 10-15, and 10-16 in ASCE 41 [10], use the modeling parameters, nonlinear acceptance criteria and linear m-factors for the Collapse Prevention condition from Chapter 10 of ASCE 41 [10] for primary and secondary components. Use the ASCE 41 modeling parameters and guidance, including definitions of stiffness, to create the analytical model.

Replace Table 10-7 of ASCE 41 [10] with Table 6, which contains the nonlinear modeling parameters and acceptance criteria for reinforced concrete beams. Replace Table 10-13 of ASCE 41 [10] with Table 7, which contains the acceptance criteria for linear modeling of reinforced concrete beams.

Replace Table 10-15 of ASCE 41 [10] with Table 8, which contains the nonlinear modeling parameters and acceptance criteria for two-way slabs and slab-column connections. Replace Table 10-16 of ASCE 41 [10] with Table 9, which contains the acceptance criteria for linear modeling of two-way slabs and slab-column connections.

#### 4.5 ~~ENHANCED LOCAL RESISTANCE FOR REINFORCED CONCRETE~~

This section is removed in its entirety.



**Table 6. Nonlinear Modeling Parameters and Acceptance Criteria for Reinforced Concrete Beams (Replacement for Table 10-7 in ASCE 41)**

Conditions			Modeling Parameters <sup>1</sup>			Acceptance Criteria <sup>1,2</sup>
			Plastic Rotations Angle, radians		Residual Strength Ratio	Plastic Rotations Angle, radians
			a	b	c	
<b>i. Beams controlled by flexure<sup>3</sup></b>						
$\frac{\rho - \rho'}{\rho_{bal}}$	Trans. Reinf. <sup>4</sup>	$\frac{V}{b_w d \sqrt{f'_c}}$ <sup>5</sup>				
≤ 0.0	C	≤ 3	0.063	0.1	0.2	0.1
≤ 0.0	C	≥ 6	0.05	0.08	0.2	0.08
≥ 0.5	C	≤ 3	0.05	0.06	0.2	0.06
≥ 0.5	C	≥ 6	0.038	0.04	0.2	0.04
≤ 0.0	NC	≤ 3	0.05	0.06	0.2	0.06
≤ 0.0	NC	≥ 6	0.025	0.03	0.2	0.03
≥ 0.5	NC	≤ 3	0.025	0.03	0.2	0.03
≥ 0.5	NC	≥ 6	0.013	0.02	0.2	0.02
<b>ii. Beams controlled by shear<sup>3</sup></b>						
Stirrup spacing ≤ d/2			0.003	0.02	0.2	0.02
Stirrup spacing > d/2			0.003	0.01	0.2	0.01
<b>iii. Beams controlled by inadequate development or splicing along the span<sup>3</sup></b>						
Stirrup spacing ≤ d/2			0.003	0.02	0	0.02
Stirrup spacing > d/2			0.003	0.01	0	0.01
<b>iv. Beams controlled by inadequate embedment into beam-column joint<sup>3</sup></b>						
			0.015	0.03	0.2	0.03
<p>1. Linear interpolation between values listed in the table shall be permitted. See Section 3.2.4 for definition of primary and secondary components and Figure 3.7 for definition of nonlinear modeling parameters a, b, and c.</p> <p>2. Primary and secondary component demands shall be within secondary component acceptance criteria where the full backbone curve is explicitly modeled including strength degradation and residual strength, in accordance with Section 7.5.3.2 of ASCE 41 [10].</p> <p>3. Where more than one of the conditions i, ii, iii and iv occurs for a given component, use the minimum appropriate numerical value from the table.</p> <p>4. "C" and "NC" are abbreviations for conforming and nonconforming transverse reinforcement. A component is conforming if, within the flexural plastic hinge region, hoops are spaced at ≤ d/3, and if, for components of moderate and high ductility demand, the strength provided by the hoops (V<sub>s</sub>) is at least three-fourths of the design shear. Otherwise, the component is considered nonconforming.</p> <p>5. V is the design shear force calculated using limit-state analysis procedures in accordance with Section 10.4.2.4.1 of ASCE 41 [10].</p>						



**Table 7. Acceptance Criteria for Linear Models of Reinforced Concrete Beams (Replacement for Table 10-13 in ASCE 41 [10])**

Conditions			m-factors <sup>1</sup>	
			Component Type	
			Primary Components	Secondary Components
i. Beams controlled by flexure <sup>2</sup>				
$\frac{\rho - \rho'}{\rho_{bal}}$	Trans. Reinf. <sup>3</sup>	$\frac{V}{b_w d \sqrt{f'_c}}$ <sup>4</sup>		
≤ 0.0	C	≤ 3	16	19
≤ 0.0	C	≥ 6	9	9
≥ 0.5	C	≤ 3	9	9
≥ 0.5	C	≥ 6	6	7
≤ 0.0	NC	≤ 3	9	9
≤ 0.0	NC	≥ 6	6	7
≥ 0.5	NC	≤ 3	6	7
≥ 0.5	NC	≥ 6	4	5
ii. Beams controlled by shear <sup>2</sup>				
Stirrup spacing ≤ d/2			1.75	4
Stirrup spacing > d/2			1.75	3
iii. Beams controlled by inadequate development or splicing along the span <sup>2</sup>				
Stirrup spacing ≤ d/2			1.75	4
Stirrup spacing > d/2			1.75	3
iv. Beams controlled by inadequate embedment into beam-column joint <sup>2</sup>				
			3	4
<p>1. Linear interpolation between values listed in the table shall be permitted. See Section 3.2.4 for definition of primary and secondary components and Figure 3-7 for definition of nonlinear modeling parameters a, b, and c.</p> <p>2. Where more than one of the conditions i, ii, iii, and iv occurs for a given component, use the minimum appropriate numerical value.</p> <p>3. "C" and "NC" are abbreviations for conforming and nonconforming transverse reinforcement. A component is conforming if, within the flexural plastic hinge region, hoops are spaced at ≤ d/3, and if, for components of moderate and high ductility demand, the strength provided by the hoops (<math>V_s</math>) is at least three-fourths of the design shear. Otherwise, the component is considered nonconforming.</p> <p>4. V is the design shear force calculated using limit-state analysis procedures in accordance with Section 10.4.2.4.1 of ASCE 41 [10].</p>				



**Table 8. Modeling Parameters and Acceptance Criteria for Nonlinear Models of Two-Way Slabs and Slab-Column Connections (Replacement for Table 10-15 in ASCE 41 [10])**

Conditions		Modeling Parameters <sup>1</sup>			Acceptance Criteria <sup>1,2</sup>
		Plastic Rotations Angle, radians		Residual Strength Ratio	Plastic Rotations Angle, radians
		a	b	c	
i. Slabs controlled by flexure, and slab-column connections <sup>3</sup>					
$V_g/V_o^2$	Continuity Reinforcement <sup>3</sup>				
< 0.2	Yes	0.05	0.10	0.2	0.100
≥ 0.4	Yes	0.00	0.04	0.2	0.080
≤ 0.2	No	0.02	0.02	-	0.020
≥ 0.4	No	0.00	0.00	-	0.000
ii. Slabs controlled by inadequate development or splicing along the span <sup>3</sup>					
		0	0.02	0	0.02
iii. Slabs controlled by inadequate embedment into the slab-column joint <sup>3</sup>					
		0.015	0.03	0.2	0.03
<p>1. Linear interpolation between values listed in the table shall be permitted. See Section 3.2.4 for definition of primary and secondary components and Figure 3-7 for definition of nonlinear modeling parameters a, b, and c.</p> <p>2. Primary and secondary component demands shall be within secondary component acceptance criteria where the full backbone curve is explicitly modeled including strength degradation and residual strength, in accordance with Section 7.5.3.2 of ASCE 41 [10].</p> <p>3. Where more than one of the conditions i, ii, iii and iv occurs for a given component, use the minimum appropriate numerical value from the table.</p> <p>4. <math>V_g</math> = the gravity shear acting on the slab critical section as defined by ACI 318; <math>V_o</math> = the direct punching shear strength as defined by ACI 318 [3].</p> <p>5. Under the heading "Continuity Reinforcement" use "Yes" where at least one of the main bottom bars in each direction is effectively continuous through the column cage. Where the slab is post-tensioned, use "Yes" where at least one of the post-tensioning tendons in each direction passes through the column cage. Otherwise, use "No".</p>					



**Table 9. Acceptance Criteria for Linear Models of Two-Way Slabs and Slab-Column Connections (Replacement for Table 10-16 in ASCE 41 [10])**

Conditions		m-factors <sup>1</sup>	
		Component Type	
		Primary Components	Secondary Components
i. Slabs controlled by flexure, and slab-column connections <sup>2</sup>			
$V_g/V_o^3$	Continuity Reinforcement <sup>4</sup>		
$\leq 0.2$	Yes	6	7
$\geq 0.4$	Yes	1	5
$\leq 0.2$	No	3	3
$\geq 0.4$	No	1	1
ii. Slabs controlled by inadequate development or splicing along the span <sup>2</sup>			
		-	4
iii. Slabs controlled by inadequate embedment into the slab-column joint <sup>2</sup>			
		-	4
<p>1. Linear interpolation between values listed in the table shall be permitted. See Section 3.2.4 for definition of primary and secondary components and Figure 3-7 for definition of nonlinear modeling parameters a, b, and c.</p> <p>2. Where more than one of the conditions i, ii, iii and iv occurs for a given component, use the minimum appropriate numerical value from the table.</p> <p>3. <math>V_g</math> = the gravity shear acting on the slab critical section as defined by ACI 318 [3]; <math>V_o</math> = the direct punching shear strength as defined by ACI 318 [3].</p> <p>4. Under the heading "Continuity Reinforcement" use "Yes" where at least one of the main bottom bars in each direction is effectively continuous through the column cage. Where the slab is post-tensioned, use "Yes" where at least one of the post-tensioning tendons in each direction passes through the column cage. Otherwise, use "No".</p>			



## 5 STRUCTURAL STEEL

Chapter 5 of the UFC 4-023-03 [31] is adopted with the following modifications:

1. Modeling and acceptance criteria for primary and secondary components have been revised from Life Safety to Collapse Prevention.
2. All references to Enhanced Local Resistance (ELR) and Tie Force analysis methods are removed.

This chapter provides the specific requirements for designing a structural steel building to resist progressive collapse. Appendix E demonstrates the application of the structural steel design requirements for a 4-story building.

If composite construction with other materials is employed, use the design guidance from the appropriate material chapter in this document for those structural elements or portions of the structure.

### 5.1 MATERIAL PROPERTIES FOR STRUCTURAL STEEL

Apply the appropriate over-strength factors to the calculation of the design strengths for the Alternate Path method. The over-strength factors are provided in ASCE 41 [10] Table 9-3.

### 5.2 STRENGTH REDUCTION FACTOR $\phi$ FOR STRUCTURAL STEEL

For the Alternate Path methods, use the appropriate strength reduction factor  $\phi$  specified in ANSI/AISC 360 *Specification for Structural Steel Buildings* [8] for the component and behavior under consideration.

### 5.3 ~~TIE FORCE REQUIREMENTS FOR STEEL~~

This section is removed in its entirety.

### 5.4 ALTERNATE PATH METHOD FOR STEEL

#### 5.4.1 GENERAL

Use the Alternate Path method in Section 3.2 to verify that the structure can meet the acceptance criteria defined in Section 3.2.10.

#### 5.4.2 CONNECTION ROTATIONAL CAPACITY

For new and existing construction, the design strength and rotational capacities of beams and beam-to-column connections shall be determined with the guidance found in ASCE 41 [10], as modified with the acceptance criteria provided in Section 5.4.3.

#### 5.4.3 MODELING AND ACCEPTANCE CRITERIA FOR STRUCTURAL STEEL

With the exception of the connections and elements discussed later in this section, use the modeling parameters, nonlinear acceptance criteria and linear m-factors for the Collapse Prevention condition from





Chapter 9 of ASCE 41 [10] for primary and secondary components. Use the modeling parameters and guidance, including definitions of stiffness, to create the analytical model.

Columns under high axial load ( $P/P_{CL} > 0.5$ ) shall be considered force-controlled, with the considered loads (P and M) equal to the maximum loads from the analysis. The P-M interaction equation shall not exceed unity. For  $P/P_{CL} \leq 0.5$ , the interaction equation shall be used with the moment considered as deformation-controlled and the axial force as force-controlled.

Nonlinear and linear acceptance criteria for structural steel components shall meet the Collapse Prevention condition for primary and secondary elements provided in Tables 9-4, 9-6 and 9-7 of ASCE 41 [10], except as follows:

- For the Fully Restrained (FR) and Partially Restrained (PR) connections listed in Table 10 and Table 11 in this document, use the specified plastic rotations, modeling parameters and m-factors, as given.
- For the Double Angles PR connection, the expected flexural strength shall be determined for each of the three limit states listed in Table 10 and Table 11, using accepted analytical procedures.
- For the Simple Shear Tab, the expected flexural strength will be taken as the smallest flexural strength determined with limit state analysis for bolt shear, weld failure, block shear, bearing, plate flexure or other limit states as appropriate.

## 5.5 ~~ENHANCED LOCAL RESISTANCE FOR STRUCTURAL STEEL~~

This section is removed in its entirety.



**Table 10. Acceptance Criteria for Linear Static Modeling of Steel Frame Connections**

Connection Type	Linear Acceptance Criteria	
	m-factors	
	Primary <sup>(1)</sup>	Secondary <sup>(1)</sup>
Fully Restrained Moment Connections		
Improved WUF with Bolted Web	3.1 - 0.032d	6.2 - 0.065d
Reduced Beam Section (RBS)	6.9 - 0.032d	8.4 - 0.032d
WUF	3.9 - 0.043d	5.5 - 0.064d
SidePlate®	6.7 - 0.039d <sup>(2)</sup>	11.1 - 0.062d
Partially Restrained Moment Connections (Relatively Stiff)		
Double Split Tee		
a. Shear in Bolt	6	8
b. Tension in Bolt	2.5	4
c. Tension in Tee	2	2
d. Flexure in Tee	7	14
Partially Restrained Moment Connections (Flexible)		
Double Angles		
a. Shear in Bolt	5.8 - 0.107d <sub>bg</sub> <sup>(3)</sup>	8.7 - 0.161d <sub>bg</sub>
b. Tension in Bolt	1.5	4
c. Flexure in Angles	8.9 - 0.193d <sub>bg</sub>	13.0 - 0.290d <sub>bg</sub>
Simple Shear Tab	5.8 - 0.107d <sub>bg</sub>	8.7 - 0.161d <sub>bg</sub>
(1) Refer to Section 3.2.4 for determination of Primary and Secondary classification. (2) d = depth of beam, in (3) d <sub>bg</sub> = depth of bolt group, in		



**Table 11. Modeling Parameters and Acceptance Criteria for Nonlinear Modeling of Steel Frame Connections**

Connection Type	Nonlinear Modeling Parameters <sup>(1)</sup>			Nonlinear Acceptance Criteria	
	Plastic Rotation Angle, radians		Residual Strength Ratio	Plastic Rotation Angle, radians	
	a	b		Primary <sup>(2)</sup>	Secondary <sup>(2)</sup>
Fully Restrained Moment Connections					
Improved WUF with Bolted Web	0.021 - 0.0003d	0.050 - 0.0006d	0.2	0.021 - 0.0003d	0.050 - 0.0006d
Reduced Beam Section (RBS)	0.050 - 0.0003d	0.070 - 0.0003d	0.2	0.050 - 0.0003d	0.070 - 0.0003d
WUF	0.0284 - 0.0004d	0.043 - 0.0006d	0.2	0.0284 - 0.0004d	0.043 - 0.0006d
SidePlate®	0.089 - 0.0005d <sup>(3)</sup>	0.169 - 0.0001d	0.6	0.089 - 0.0005d	0.169 - 0.0001d
Partially Restrained Moment Connections (Relatively Stiff)					
Double Split Tee					
a. Shear in Bolt	0.036	0.048	0.2	0.03	0.04
b. Tension in Bolt	0.016	0.024	0.8	0.013	0.02
c. Tension in Tee	0.012	0.018	0.8	0.01	0.015
d. Flexure in Tee	0.042	0.084	0.2	0.035	0.07
Partially Restrained Simple Connections (Flexible)					
Double Angles					
a. Shear in Bolt	0.0502 - 0.0015d <sub>bg</sub> <sup>(4)</sup>	0.072 - 0.0022d <sub>bg</sub>	0.2	0.0502 - 0.0015d <sub>bg</sub>	0.0503 - 0.0011d <sub>bg</sub>
b. Tension in Bolt	0.0502 - 0.0015d <sub>bg</sub>	0.072 - 0.0022d <sub>bg</sub>	0.2	0.0502 - 0.0015d <sub>bg</sub>	0.0503 - 0.0011d <sub>bg</sub>
c. Flexure in Angles	0.1125 - 0.0027d <sub>bg</sub>	0.150 - 0.0036d <sub>bg</sub>	0.4	0.1125 - 0.0027d <sub>bg</sub>	0.150 - 0.0036d <sub>bg</sub>
Simple Shear Tab	0.0502 - 0.0015d <sub>bg</sub>	0.1125 - 0.0027d <sub>bg</sub>	0.2	0.0502 - 0.0015d <sub>bg</sub>	0.1125 - 0.0027d <sub>bg</sub>
(1) Refer to Figure 3-7 for definition of nonlinear modeling parameters a, b, and c (2) Refer to Section 3-2.4 for determination of Primary and Secondary classification (3) d = depth of beam, inch (4) d <sub>bg</sub> = depth of bolt group, inch					



## 6 MASONRY

Chapter 6 of the UFC 4-023-03 [31] is adopted with the following modifications:

1. All references to Enhanced Local Resistance (ELR) and Tie Force analysis methods are removed.

This chapter provides the specific requirements for designing a masonry building to resist progressive collapse.

If composite construction with other materials is employed, use the design guidance from the appropriate material chapter in this document for those structural elements or portions of the structure.

### 6.1 MATERIAL PROPERTIES FOR MASONRY

Apply the appropriate over-strength factors to the calculation of the design strengths for the Alternate Path method. The over-strength factors are provided in ASCE 41 [10] in Table 11-1.

### 6.2 STRENGTH REDUCTION FACTOR $\phi$ FOR MASONRY

For the Alternate Path methods, use the appropriate strength reduction factor  $\phi$  specified in ACI 530 *Building Code Requirements for Masonry Structures* [4] for the component and behavior under consideration.

### 6.3 ~~TIE FORCE REQUIREMENTS FOR MASONRY~~

This section is removed in its entirety.

### 6.4 ALTERNATE PATH METHOD FOR MASONRY

#### 6.4.1 GENERAL

Use the Alternate Path method in Section 3.2 to verify that the structure can meet the acceptance criteria defined in Section 3.2.10.

#### 6.4.2 MODELING AND ACCEPTANCE CRITERIA FOR MASONRY

Use the modeling parameters, nonlinear acceptance criteria and linear m-factors for the Life Safety condition from Chapter 11 of ASCE 41 [10] for primary and secondary components. Use the modeling parameters and guidance, including definitions of stiffness, to create the analytical model.

### 6.5 ~~ENHANCED LOCAL RESISTANCE FOR MASONRY~~

This section is removed in its entirety.



## 7 WOOD

Chapter 7 of the UFC 4-023-03 [31] is adopted with the following modifications:

1. All references to Enhanced Local Resistance (ELR) and Tie Force analysis methods are removed.

This chapter provides the specific requirements for designing a wood building to resist progressive collapse.

Wood construction takes several forms in current practice. As described in the 1996 version of AF&PA/ASCE 16, *Load and Resistance Factor Design Manual for Engineered Wood Construction* [5], wood construction can be categorized as wood frame, non-combustible wall-wood joist, and heavy timber.

If composite construction with other materials is employed, use the design guidance from the appropriate material chapter in this document for those structural elements or portions of the structure.

### 7.1 MATERIAL PROPERTIES FOR WOOD

Per ASCE 41 [10], default expected strength values for wood materials shall be based on design resistance values from AF&PA/ASCE 16 [5]. In addition, ASCE 41 [10] provides default expected strength values for shear walls and wood diaphragms. When default lower bound strength values are needed, multiply the expected strength values by 0.85.

### 7.2 STRENGTH REDUCTION FACTOR $\phi$ FOR WOOD

For the Alternate Path method, use the appropriate strength reduction factor  $\phi$  specified in AF&PA/AWC *National Design Specification for Wood Construction* [24] for the component and behavior under consideration.

### 7.3 TIME EFFECT FACTOR $\lambda$ FOR WOOD

The time effect factor  $\lambda$  for wood is 1.0.

### 7.4 ~~TIE FORCE REQUIREMENTS FOR WOOD~~

This section is removed in its entirety.

### 7.5 ALTERNATE PATH METHOD FOR WOOD

#### 7.5.1 GENERAL

Use the Alternate Path method in Section 3.2 to verify that the structure can meet the acceptance criteria defined in Section 3.2.10.

#### 7.5.2 MODELING AND ACCEPTANCE CRITERIA FOR WOOD



Use the modeling parameters, nonlinear acceptance criteria and linear m-factors for the Life Safety condition from Chapter 12 of ASCE 41 [10] for primary and secondary components. Use the modeling parameters and guidance, including definitions of stiffness, to create the analytical model.

## 7.6 ~~ENHANCED LOCAL RESISTANCE FOR WOOD~~

This section is removed in its entirety.



## 8 COLD-FORMED STEEL

Chapter 8 of the UFC 4-023-03 [31] is adopted with the following modifications:

1. All references to Enhanced Local Resistance (ELR) and Tie Force analysis methods are removed.

This chapter provides the specific requirements for designing a cold-formed steel building to resist progressive collapse.

If composite construction with other materials is employed, use the design guidance from the appropriate material chapter in this document for those structural elements or portions of the structure.

### 8.1 MATERIAL PROPERTIES FOR COLD-FORMED STEEL

ASCE 41 provides default expected strength values for light metal framing shear walls. When default lower bound strength values are needed, multiply the expected strength values by 0.85.

### 8.2 STRENGTH REDUCTION FACTOR $\phi$ FOR COLD-FORMED STEEL

For the Alternate Path method, use the appropriate strength reduction factor  $\phi$  specified in *AISI/COS/NASPEC AISI Standard North American Specification for the Design of Cold-Formed Steel Structural Members [7]* for the component and behavior under consideration.

### 8.3 ~~TIE FORCE REQUIREMENTS FOR COLD-FORMED STEEL~~

This section is removed in its entirety.

### 8.4 ALTERNATE PATH METHOD FOR COLD-FORMED STEEL

#### 8.4.1 GENERAL

Use the Alternate Path method in Section 3.2, where applicable, to verify that the structure meets the allowable limits defined in Section 3.2.10.

#### 8.4.2 MODELING AND ACCEPTANCE CRITERIA FOR COLD-FORMED STEEL

Use the modeling parameters, nonlinear acceptance criteria and linear m-factors for the Life Safety condition from Chapter 12 of ASCE 41 [10] for primary and secondary components. Use the modeling parameters and guidance, including definitions of stiffness, to create the analytical model.

### 8.5 ~~ENHANCED LOCAL RESISTANCE FOR COLD-FORMED STEEL~~

This section is removed in its entirety.



# **APPENDIX A**

# **REFERENCES**

---





## APPENDIX A - REFERENCES

- [1] A Proposed Enhanced Local Resistance Procedure for Perimeter Columns and Load-bearing Walls, K. Marchand, D. Stevens, February 2008 - Protection Engineering Consultants, 4594 Hwy 281 North, Suite 100, Spring Branch, TX 78070
- [2] An Experimental and Computational Study of Steel Moment Connections under a Column Removal Scenario. NIST Technical Note 1669. National Institute of Standards and Technology. F. Sadek, J. Main, H.S. Lew, S.D. Robert, V.P. Chiarito, S. El-Tawil. Gaithersburg, MD. 2010.
- [3] ACI 318-11, Building Code Requirements for Structural Concrete - American Concrete Institute, P.O. Box 9094, Farmington Hills, MI 48333-9094
- [4] ACI 530-11, Building Code Requirements for Masonry Structures - American Concrete Institute, P.O. Box 9094, Farmington Hills, MI 48333-9094
- [5] AF&PA/ASCE 16-96, Load and Resistance Factor Design Manual for Engineered Wood Construction, 1996
- [6] AISC 341-10 Seismic Provisions for Structural Steel Buildings - American Institute of Steel Construction, One E. Wacker Dr., Suite 3100 Chicago, IL 60601-2000
- [7] AISI, Standard North American Specification for the Design of Cold-Formed Steel Structural Members, American Iron and Steel Institute, 1101 Seventeenth Street NW, Suite 1300, Washington, DC 20036-4700
- [8] ANSI/AISC 360-10, Specification for Structural Steel Buildings, American Institute of Steel Construction, One E. Wacker Dr., Suite 3100 Chicago, IL 60601-2000
- [9] ASCE 7-10, Minimum Design Loads for Buildings and Other Structures, American Society of Civil Engineers, 1801 Alexander Bell Drive, Reston, VA 20191-4400
- [10] ASCE 41-13, Seismic Rehabilitation of Existing Buildings - American Society of Civil Engineers, 1801 Alexander Bell Drive, Reston, VA 20191-4400
- [11] Best Practices for Reducing the Potential for Progressive Collapse in Buildings NISTIR 7396, 2007 - National Institute of Standards and Technology, Gaithersburg, MD
- [12] Department of Defense Interim Antiterrorism/Force Protection Construction Standards, Guidance on Structural Requirements, 2001 - US Army Corps of Engineers, Protective Design Center, Omaha District, 215 N. 17th St., Omaha, NE 68102-4978
- [13] Dynamic Increase Factors (DIF) and Load Increase Factors (LIF) for Alternate Path Procedures, A. McKay, K. Marchand, and D. Stevens, January 2008 - Protection Engineering Consultants, 4594 Hwy 281 North, Suite 100, Spring Branch, TX 78070
- [14] Engineering Analysis and Guidance for Structural Steel Issues in Progressive Collapse, Tasks 5.7 and 5.19, J. Karns, D. Houghton, January 2008 - Myers, Houghton and Partners (MHP), 4500 East Pacific Coast Highway, Suite 100, Long Beach, CA 90804
- [15] FEMA 350, Recommended Seismic Design Criteria for New Steel Moment- Frame Buildings, 2000 - Federal Emergency Management Agency, 500 C Street, SW, Washington, DC
- [16] FEMA 355D, State of the Art Report on Connection Performance, 2000 - Federal Emergency Management Agency, 500 C Street, SW, Washington, DC
- [17] Final Report for Assessment and Proposed Approach for Tie Forces in Framed and Load-bearing Wall Structures, D.J. Stevens, May 2008 - Protection Engineering Consultants, 4594 Hwy 281 North, Suite 100, Spring Branch, TX 78070



- [18] GSA Facility Security Requirements for Explosive Devices Applicable to Facility Security Levels III and IV, 2 August 2011
- [19] GSA Steel Frame Bomb Blast and Progressive Collapse Test Program Report (2004-2007) 2008 -- General Services Administration, Washington, DC
- [20] International Building Code - International Code Council, 500 New Jersey Avenue, NW, Washington, DC 20001-2070
- [21] Manual of Steel Construction, Load and Resistance Factor Design, American Institute of Steel Construction, One E. Wacker Dr., Suite 3100 Chicago, IL 60601-2000
- [22] Methodology Manual for the Single-Degree-of-Freedom Blast Effects Design Spreadsheets (SBEDS) PDC TR-06-01 Rev 1, 2008 - US Army Corps of Engineers, Protective Design Center, Omaha District, 215 N. 17th St., Omaha, NE 68102-4978
- [23] Multi-storey Timber Frame Buildings, A Design Guide, 2003 - Building Research Establishment, Bucknalls Lane, Garston, Watford WD25 9XX, England
- [24] National Design Specification for Wood Construction - American Forest and Paper Association, American Wood Council 1111 19th Street NW, Suite 800 Washington, DC 20036
- [25] National Workshop on Prevention of Progressive Collapse - National Institute of Building Sciences, Washington, DC
- [26] The Risk Management Process of Federal Facilities: An Interagency Security Committee Standard, August 2013, Including Appendix A and B
- [27] Progressive Collapse Analysis and Design Guidelines for New Federal Office Buildings and Major Modernization Projects, 2003 - General Services Administration, Washington, DC
- [28] Review of International Research on Structural Robustness and Disproportionate Collapse. Centre for the Protection of National Infrastructure (CPNI). October 2011.
- [29] The Avoidance of Progressive Collapse: Regulatory Approaches to the Problem, 1975 - National Bureau of Standards, Washington, DC 20234, Report Number NBS-GCR 75-48
- [30] The UK and European Regulations for Accidental Actions, D. B. Moore, 2002 - National Institute of Building Sciences, Washington, DC
- [31] UFC 4-023-03, Design of Buildings to Resist Progressive Collapse, dated 14 July 2009, including change 2 – 1 June 2013
- [32] UFC 3-301-01, Structural Engineering - Department of Defense, Washington, DC
- [33] UFC 3-340-01, Design and Analysis of Hardened Structures to Conventional Weapons Effects - Department of Defense, Washington, DC
- [34] UFC 4-010-01 DoD Minimum Antiterrorism Standards for Buildings - Department of Defense, Washington, DC
- [35] Prequalified Connections for Special and Intermediate Steel Moment Frames for Seismic Applications, ANSI/AISC 358-10, ANSI/AISC 358s1-11, American Institute of Steel Construction, One East Wacker Drive, Suite 700, Chicago, Illinois 60601-1802
- [36] AC129, Steel Moment Frame Connection Systems, October 2012, ICC Evaluation Service, LLC, 900 Montclair Road, Suite A, Birmingham, AL 35213



# **APPENDIX B**

# **DEFINITIONS**



## B1 DEFINITIONS

The majority of the following definitions are taken directly from UFC 4-023-03 [31] Appendix B. Those definitions that have been added or modified for the purposes of these Guidelines are indicated by a line in the left margin.

**New or Replacing Leases.** Leases with new terms and conditions and new lease contract numbers, applicable for either a new requirement or to replace an existing expiring lease.

**Succeeding Leases.** Non-competitive (sole-source) lease acquisitions secured to cover continued occupancy of the current premises at the end of a lease term without a break in continuous tenancy. They establish new terms and conditions and have a new lease contract number. Such a lease would generally be used where acceptable new locations are not identified, or where acceptable locations are identified but a cost-benefit analysis indicates that award to an offeror other than the current Lessor will result in substantial relocation costs or duplication costs to the Government and the Government cannot expect to recover such costs through competition.

**Superseding Leases.** New leases that replace an existing lease before expiration. It is procured following non-competitive sole-source procedures. They establish new terms and conditions and have a new lease contract number. The Government considers executing a superseding lease to replace an existing lease when the Government needs numerous or detailed modifications to a space that would cause complications or substantially change the existing lease, or where better terms are available in a market. The Lease Contracting Officer must ultimately decide whether to pursue a superseding lease rather than an alteration, extension, or expansion of an existing lease.

**Full and Open Competition.** All responsible sources are permitted to compete. Required to follow advertising and publicizing practices necessary to promote competition for the location, type, and amount of space and use restrictive provisions or conditions only to the extent necessary to satisfy the client agency's needs or as authorized by law. All offerors are given an opportunity to submit offers - that is, the procurement was known to the public, and solicitations were available to all interested offerors.

**Lease Construction.** Government-planned or Government-required new construction of a building resulting from a lease solicitation. This generally refers to projects where the Government requirements drive a new construction solution in order to satisfy an agency's space requirements.

**Controlled Public Access.** For the purposes of these Guidelines, areas with controlled public access are considered those that meet the Access Control requirements of Appendix B of the ISC Risk Management Process [26] as follows:

- (1) Badge identification (ID) systems for employee access with guard personnel for visual and physical inspection before entry.
- (2) X-ray and magnetometer screening for all visitors and their property.

**Design-Basis Threat (DBT).** Defined in the ISC Risk Management Process [26] as "a profile of the type, composition and capabilities of an adversary." For the purposes of these guidelines, the DBT is considered an explosive threat.



**Existing Construction.** Defined in the ISC Risk Management Process [26] as “a facility that has already been constructed or for which the design and construction effort has reached a stage where design changes may be cost prohibitive.”

**Facility Security Level (FSL).** Defined in the ISC Risk Management Process [26] as “a categorization based on the analysis of several security-related facility factors, which serves as the basis for the implementation of physical security measures specified in the ISC standards”.

**Government-Owned.** Defined in the ISC Risk Management Process [26] as “a facility owned by the United States and under the custody and control of a Federal department or agency.”

**Major Modernization.** A major structural renovation such as that required for a seismic upgrade. Note, for the purposes of these Guidelines restoration and/or replacement of major non-structural systems (i.e. mechanical, electrical) or interior work is not considered a major modernization.

**New Construction.** Defined in the ISC Risk Management Process [26] as “a project in which an entirely new facility is to be built.”

**Deformation-Controlled Action.** A deformation-controlled action provides a resistance that is proportional to the imposed deformation until the peak strength is reached, after which the resistance remains at a significant level, as the deformation increases. Classification as a deformation-controlled action is not based on engineering judgment and must follow the guidance presented in Section 3.2.5.

**Expected Strength.** The expected strength of a component is the statistical mean value of yield strengths for a population of similar components, and includes consideration of the variability in material strengths as well as strain hardening and plastic section development. If a statistically-determined value for the expected strength is not available, the expected strength can be obtained by multiplying the lower bound strength (i.e., the nominal strength or strength specified in the construction documents) by the appropriate factor from Chapters 9 to 12 in ASCE 41 [10].

**Enhanced Local Resistance (ELR).** ELR is an indirect design approach implemented in the UFC 4-023-03 [31] that provides a prescribed level of out-of-plane flexural and shear resistance of perimeter building columns (including their connections, splices and base plates) and load bearing wall elements, such that the shear resistance exceeds the shear associated with the required out-of-plane enhanced flexural resistance of the columns and wall elements.

**Force-Controlled Action.** A force-controlled action provides a resistance that is proportional to the imposed deformation until the peak strength is reached, after which the resistance drops to zero. Classification as a force-controlled action is not based on engineering judgment and must follow the guidance presented in Section 3.2.5.

**Linear Static Procedure.** In a linear static procedure, the structural analysis incorporates only linear elastic materials and small deformation theory; buckling phenomena are not included in the model but are assessed through examination of the output. Inertial forces are not considered. The analysis consists of a single step, in which the deformations and internal forces are solved based on the applied loads and geometry and materials.

**Lower Bound Strength.** The lower bound strength of a component is the statistical mean minus one standard deviation of the yield strengths for a population of similar components. If a statistically-

determined value for the lower bound strength is not available, the nominal strength or strength specified in the construction documents may be used.

**Nonlinear Dynamic Procedure.** In a nonlinear dynamic procedure, inertial effects and material and geometric nonlinearities are included. A time integration procedure is used to determine the structural response as a function of time.

**Nonlinear Static Procedure.** In a nonlinear static procedure, the structural model incorporates material and geometric nonlinearities. Inertial effects are not included. An incremental or iterative approach is typically used to solve for the structural response as a function of the applied loading.

**Penultimate Column or Wall.** The column or wall that is next to the corner column or corner wall on the exterior surface, i.e., the next-to-last wall or column along the exterior of the building.

**Secondary Component.** Any component that is not a primary component is classified as secondary.

**Story.** That portion of a building between the surface of any one floor and the surface of the floor above it or, if there is no floor above it, then that portion of the building included between the surface of any floor and the ceiling or roof above it.

**Tie Forces.** The tie force method is a design approach implemented in the UFC 4-023-03 [31]. A tie force is the tensile resistance that is used to transfer the loads from the damaged region of the structure to the undamaged portion.

**Joint and Joint Rotation.** From ASCE 41 [10], a joint is an area where ends, surfaces, or edges of two or more components are attached; categorized by type of fastener or weld used and method of force transfer. As shown in Figure B1.1, a joint is the central region to which the structural members are attached. A joint possesses size, geometry, and material and, as such, the joint can rotate as a rigid body, as shown in Figure B1.2. The joint in Figure B1.2 is shown as a “+” shape, to facilitate visualization of the joint rotation,  $\Gamma$ .

Typically, deformations within the joint are ignored and only rigid body rotation is considered. However, shear deformations within the panel zone of structural steel and reinforced concrete joints can occur, as defined later.

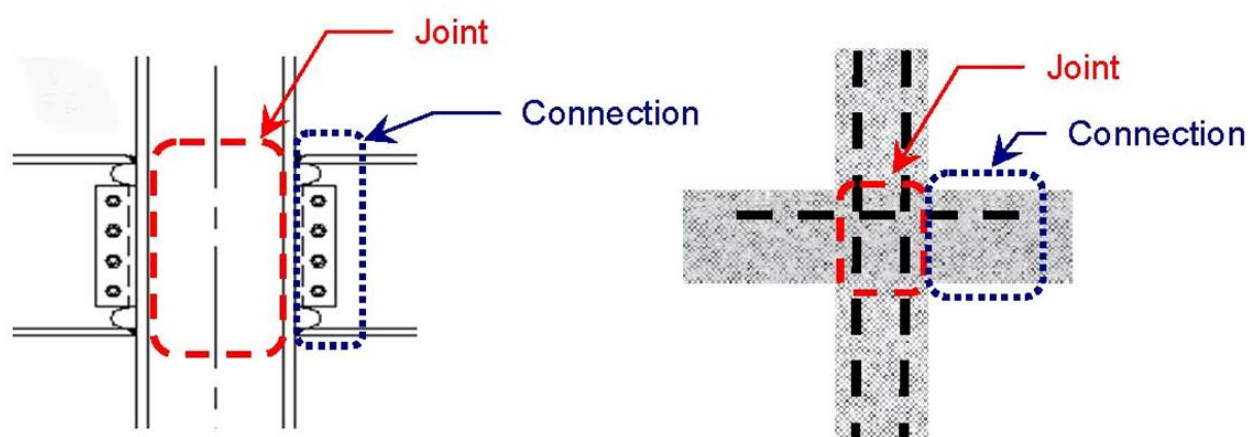
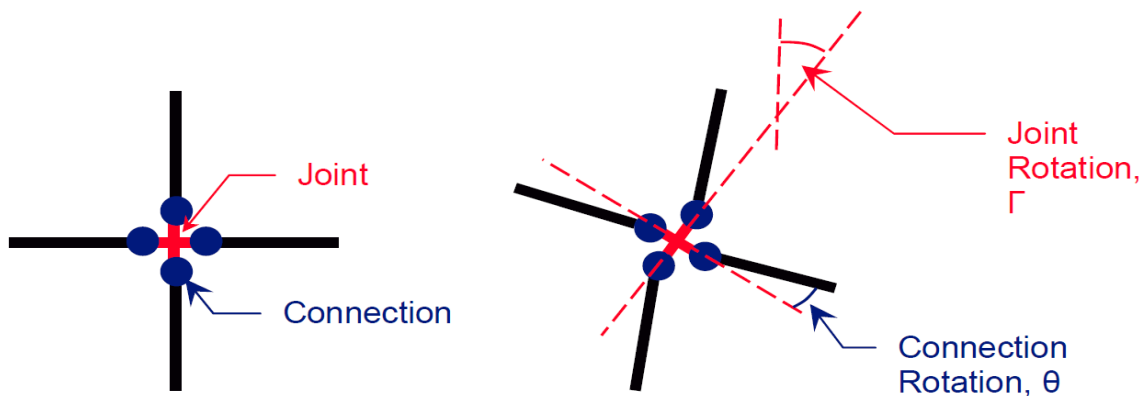


Figure B1.1. Joint and Connection Definition

**Connection and Connection Rotation.** A connection is defined as a link that transmits actions from one component or element to another component or element, categorized by type of action (moment, shear, or axial) (ASCE 41, [10]). Steel moment and reinforced concrete connections are shown in Figure B1.1. The rotation of the connection is shown in the sketches in Figure B1.2. Rotation can occur through shear and flexural deformations in the connection and may be elastic (recoverable) or plastic (permanent). The connection rotation is measured relative to the rigid body rotation of the joint as shown in Figure B1.2.



**Figure B1.2. Joint and Connection Rotations**

In a frame, calculation of the connection rotation is often determined via the chord rotation. In the case shown in Figure B1.3 the chord rotation and connection rotation  $\theta$  are identical; however, joint rotation must also be considered. The total connection rotation is the sum of the elastic and plastic rotations, defined later.

In numerical models and design software, connections are typically modeled with discrete “plastic hinges”, which exhibit a linear elastic behavior until the yield plateau is reached; in some models, the elastic rotations are ignored, due to their small value. In this case, the rotation of the discrete plastic hinge model is the connection rotation; care must be taken to insure that the rotation of the plastic hinge model only considers the connection rotation  $\theta$  and does not also include the joint rotation  $\Gamma$ .

**Yield Rotation.** Many flexural elements will deform elastically until the extreme fibers of the element reach their yield capacity and the response becomes nonlinear. While the depth of the yielded material in the cross section will gradually increase as the moment is increased, this portion of the response is typically assumed as a finite change in the slope of the moment vs. rotation curve, as shown in Figure B1.4. The yield rotation  $\theta_y$  corresponds to the flexural rotation at which the extreme fibers of the structural elements reach their yield capacity  $f_y$ . This is also called the elastic rotation as it corresponds to the end of the elastic region.

For steel beams and columns, ASCE 41 [10] allows  $\theta_y$  to be calculated as follows, where it has been assumed that the point of contraflexure occurs at the mid-length of the beam or column.

$$\text{Beams: } \theta_y = \frac{ZF_{ye}l_b}{6EI_b}$$

$$\text{Columns: } \theta_y = \frac{ZF_{ye}l_c}{6EI_c} \left( 1 - \frac{P}{P_{ye}} \right)$$



For steel structures, in ASCE 41 [10] multiples of the yield rotation  $\theta_y$  are used to define the acceptance criteria and modeling parameters in terms of plastic rotation for a number of elements (beams, columns, shear walls).

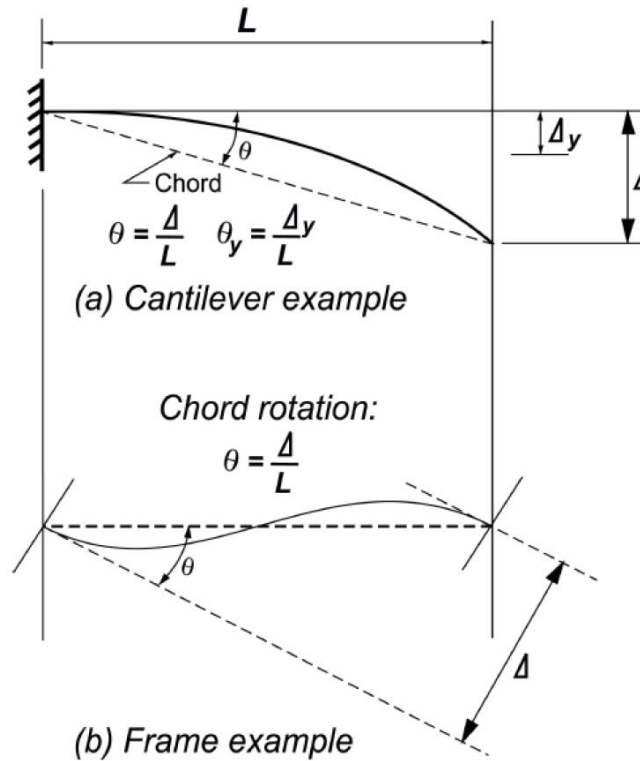


Figure B1.3. Definition of Chord Rotation (from ASCE 41 [10])

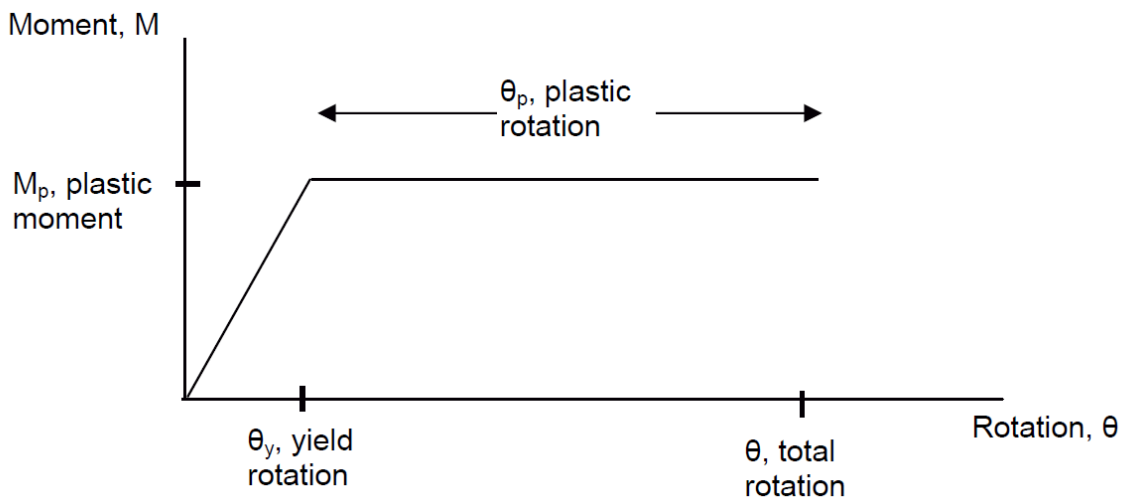
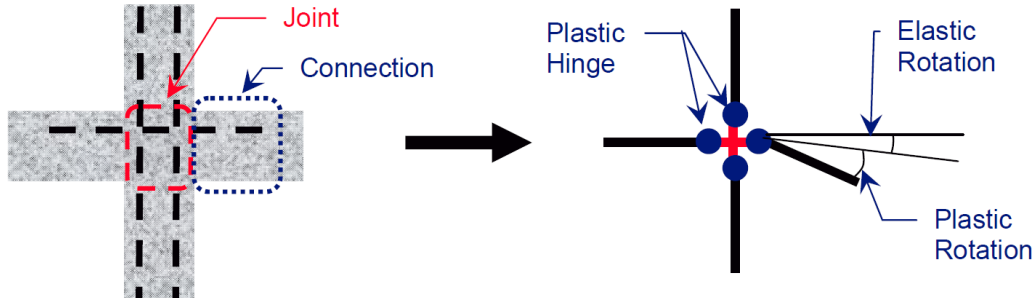


Figure B1.4. Definition of Yield Rotation, Plastic Rotation, and Total Rotation

**Plastic Rotation and Plastic Hinge.** The plastic rotation  $\theta_p$  is the inelastic or non-recoverable rotation that occurs after the yield rotation is reached and the entire cross section has yielded; see Figure B1.4.



The plastic rotation  $\theta_p$  is typically associated with a discrete plastic hinge that is inserted into a numerical frame model, as shown in Figure B1.5. The plastic hinge measures both elastic and plastic rotations, although for simplicity, the elastic portion is often ignored due to its small size.



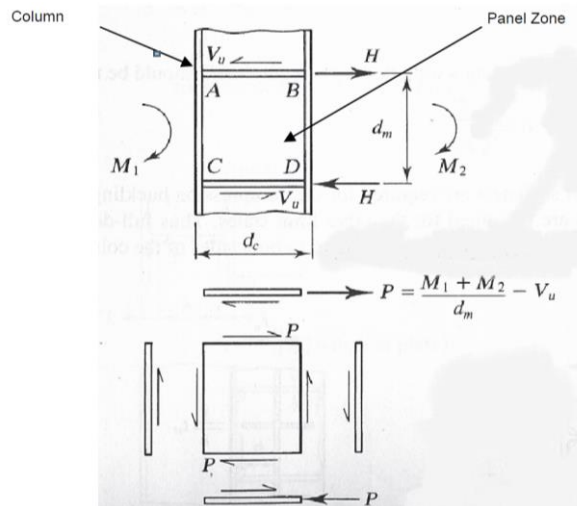
**Figure B1.5. Plastic Hinge and Rotation**

For both steel and concrete, ASCE 41 [10] specifies the acceptance criteria and the modeling parameters in terms of plastic rotation. For some steel structural elements, the criteria parameters are given in terms of multiples of the yield rotation  $\theta_y$ ; for concrete and the remainder of the structural steel elements, a numerical value for the plastic rotation is given, in units of radians.

**Total Rotation.** The total rotation  $\theta$  is the sum of the yield rotation  $\theta_y$  and the plastic rotation  $\theta_p$ .

**Panel Zone.** In steel frame structures, the panel zone is the region of high shear stress in the column web within the boundaries of the joint, which results from the large moment transferred to the column joint from a fully restrained connection; see Figure B1.6. The panel zone is an integral part of the steel frame beam-to-column moment connection. The deformation measure is the plastic angular shear rotation. Guidance for including or excluding the panel zone in steel models is given in Sections 9.4.2.2.1 and 9.4.2.2.2 in ASCE 41 [10].

Similarly, for beam-column joints in reinforced concrete framed structures, the plastic shear rotation is the deformation parameter used in the acceptance criteria; in ASCE 41 [10], only the secondary beam-column joints must be checked for shear rotation.



**Figure B1.6. Panel Zone**

**Story Drift (Wall Structures).** In ASCE 41 [10], story drift is used as the nonlinear deformation measure for load-bearing wall structures (masonry, wood, and cold formed steel). The story drift is defined as the ratio of the lateral deflection at the top of a wall segment  $\Delta$  to the overall height of the wall segment, as shown in Figure B1.7.

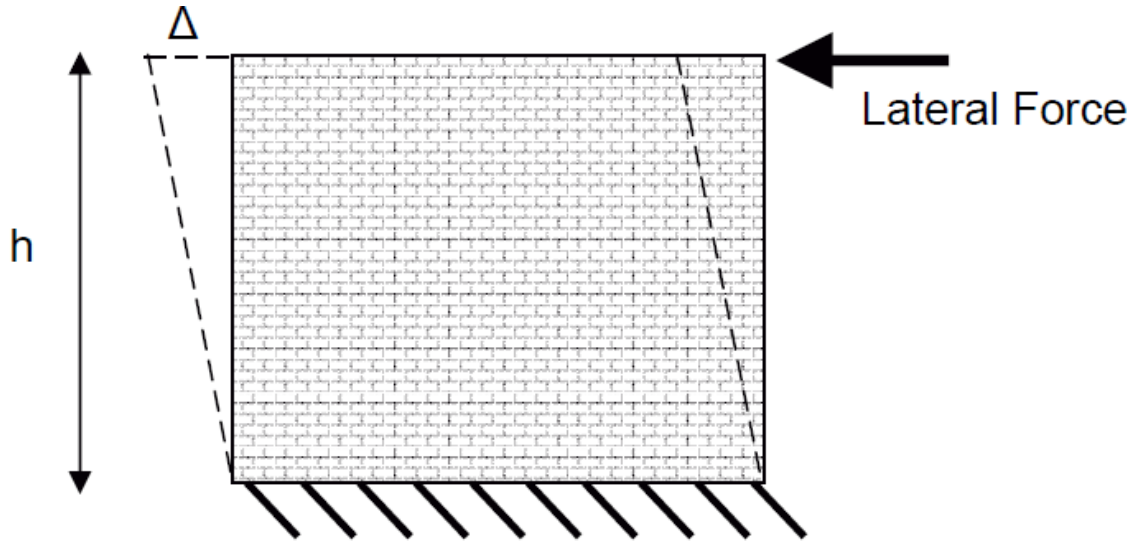


Figure B1.7. Story Drift

While the story drift deformation criteria in ASCE 41 [10] are applied to horizontal deformations due to lateral earthquake loads, this information can be used directly for progressive collapse analysis with vertical deformations due to removed wall sections, as shown in Figure B1.8.

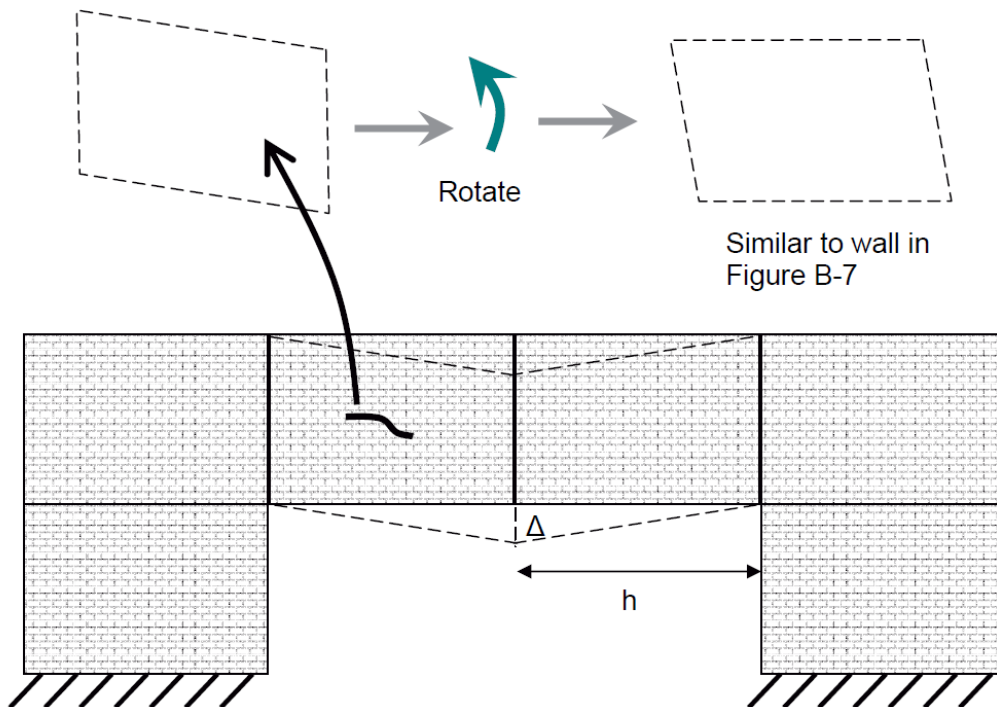


Figure B1.8. Vertical Wall Deflection (Drift)



# **APPENDIX C**

# **COMMENTARY**

---



## TABLE OF CONTENTS

<b>C1 INTRODUCTION .....</b>	<b>C1</b>
C1.1 PURPOSE.....	C1
C1.2 GUIDELINE PHILOSOPHY .....	C2
C1.2.1 DEFINITION OF PROGRESSIVE COLLAPSE .....	C2
C1.2.2 THREAT DEPENDENT APPROACH.....	C3
C1.3 APPLICABILITY .....	C3
C1.4 HOW TO USE THIS DOCUMENT .....	C3
C1.5 DOCUMENT ORGANIZATION .....	C3
C1.6 SUMMARY OF THE PROGRESSIVE COLLAPSE DESIGN PROCEDURE .....	C3
<b>C2 APPLICABILITY .....</b>	<b>C4</b>
C2.1 NEW CONSTRUCTION AND BUILDING ADDITIONS.....	C4
C2.2 NEW VS. EXISTING CONSTRUCTION .....	C4
C2.3 FACILITY SECURITY LEVELS (FSL) .....	C5
<b>C3 DESIGN PROCEDURES.....</b>	<b>C6</b>
C3.1 TIE FORCES .....	C6
C3.2 ALTERNATE PATH METHOD .....	C6
C3.2.1 GENERAL .....	C6
C3.2.2 ALTERNATIVE RATIONAL ANALYSIS .....	C7
C3.2.3 LOAD AND RESISTANCE FACTOR DESIGN .....	C8
C3.2.4 PRIMARY AND SECONDARY COMPONENTS .....	C8
C3.2.5 FORCE-AND DEFORMATION-CONTROLLED ACTIONS.....	C9
C3.2.6 EXPECTED AND LOWER BOUND STRENGTH.....	C9
C3.2.7 MATERIAL PROPERTIES.....	C9
C3.2.8 COMPONENT FORCE AND DEFORMATION CAPACITIES.....	C9
C3.2.9 REMOVAL OF LOAD BEARING ELEMENTS FOR ALTERNATE PATH METHOD .....	C9
C3.2.10 STRUCTURE ACCEPTANCE CRITERIA .....	C9
C3.2.11 LINEAR STATIC PROCEDURE.....	C10
C3.2.12 NONLINEAR STATIC PROCEDURE .....	C12
C3.2.13 NONLINEAR DYNAMIC PROCEDURE .....	C13
C3.3 ENHANCED LOCAL RESISTANCE.....	C13
C3.4 REDUNDANCY REQUIREMENTS.....	C14
C3.4.1 LOCATION REQUIREMENTS .....	C14
C3.4.2 STRENGTH REQUIREMENTS.....	C14



C3.4.3 STIFFNESS REQUIREMENTS .....C15

**C4 REINFORCED CONCRETE ..... C15**

C4.1 MATERIAL PROPERTIES FOR REINFORCED CONCRETE .....C15

C4.2 STRENGTH REDUCTION FACTOR  $\phi$  FOR REINFORCED CONCRETE .....C15

C4.3 ~~TIE FORCE REQUIREMENTS FOR REINFORCED CONCRETE.....C15~~

C4.4 ALTERNATE PATH REQUIREMENTS FOR REINFORCED CONCRETE .....C15

    C4.4.1 GENERAL .....C15

    C4.4.2 FLEXURAL MEMBERS AND JOINTS .....C15

    C4.4.3 MODELING AND ACCEPTANCE CRITERIA FOR REINFORCED CONCRETE .....C15

C4.5 ~~ENHANCED LOCAL RESISTANCE FOR REINFORCED CONCRETE.....C16~~

**C5 STRUCTURAL STEEL..... C16**

C5.1 MATERIAL PROPERTIES FOR STRUCTURAL STEEL .....C16

C5.2 STRENGTH REDUCTION FACTOR  $\phi$  FOR STRUCTURAL STEEL.....C16

C5.3 ~~TIE FORCE REQUIREMENTS FOR STEEL .....C16~~

C5.4 ALTERNATE PATH METHOD FOR STEEL .....C16

    C5.4.1 GENERAL .....C16

    C5.4.2 CONNECTION ROTATIONAL CAPACITY.....C16

    C5.4.3 MODELING AND ACCEPTANCE CRITERIA FOR STRUCTURAL STEEL.....C17

    BEST PRACTICE RECOMMENDATION .....C17

**C6 MASONRY ..... C23**

**C7 WOOD..... C23**

**C8 COLD-FORMED STEEL..... C23**



## C1 INTRODUCTION

This commentary follows a similar format as the main body of these Guidelines. With the exception of the first introductory section (Chapters 1 and 2), the general organization and content of the commentary in UFC 04-023-03 [31] has been incorporated, specifically as it relates to the Alternate Path methodology. Although not incorporated in its entirety, the applicable commentary sections of the UFC 04-023-03 [31] have been included at the level of detail such that these Guidelines are a stand-alone document and the designer need not reference the UFC 04-023-03 [31] for its application. For clarity for those familiar with the UFC 04-023-03 [31] methodology, any modifications to the Alternate Path procedures are indicated in the text in accordance with the legend below, including sections that have been removed in their entirety.

- Modified or additions to text is indicated with a line in the left margin
- Deleted text is indicated with a strike-through the text

### C1.1 PURPOSE

In 2010, the Interagency Security Committee (ISC) issued a suite of new physical security standards applicable to all Federal facilities. The ISC standards included documents which established a baseline set of physical security measures to be applied to Federal facilities based on a designated facility security level (FSL). In 2013, ISC released an updated version of the standards which combined all previously provided documents into a single document, *The Risk Management Process for Federal Facilities* "ISC Risk Management Process" [26]. The following applicable appendices were included:

- Appendix A: The Design-Basis Threat [26]
- Appendix B: Countermeasures [26]

In response to the 2010 physical security standards, GSA issued an interpretation document, *GSA Facility Security Requirements for Explosive Devices Applicable to Facility Security Levels III and IV*, "GSA Applicability" [18], which provides guidelines on how to implement the new ISC standards on GSA FSL III and IV facilities.

Both the ISC Risk Management Process [26] and GSA Applicability document [18] include changes that affect the application of progressive collapse requirements in the design of Federal buildings. These Guidelines supersede the "*GSA Progressive Collapse Analysis and Design Guidelines for New Federal Office Buildings and Major Modernization Projects 2003*" [27] document and aim to bring alignment with the current suite of ISC and GSA security standards. Specifically, this document reflects the following changes in progressive collapse requirements from the previous 2003 document:

- Applicability of progressive collapse requirements based on level of risk
- Adoption of a threat-based approach
- Adoption of the Alternate Path Methodology in UFC 04-023-03 [31]
- Clarification of the minimum number of stories that trigger progressive collapse requirements
- Alternate analysis option to allow a more risk-based approach for incorporating progressive collapse requirements in existing buildings



- Adoption of new Redundancy Requirements

Discussion of each of these changes is provided in the following applicable sections.

## C1.2 GUIDELINE PHILOSOPHY

Whereas the previous Guidelines required a rigid and consistent application of progressive collapse requirements, regardless of the facility type (i.e. new, existing, leased, owned), function, and risk-level, these Guidelines adopt the risk-based approach of the ISC Risk Management Process [26]. Accordingly, the application of the Guidelines is dependent on the FSL, which categorizes Federal facilities based on their function, size and perceived threats. In addition, for existing buildings where cost of implementation of progressive collapse mitigation measures may be impractical, employing the ISC risk-based approach allows the Government to make an informed decision on whether the existing risk is acceptable or whether mitigation measures shall be implemented to reduce it.

### C1.2.1 DEFINITION OF PROGRESSIVE COLLAPSE

ASCE 7-05 [9] defines progressive collapse as “the spread of an initial local failure from element to element resulting, eventually, in the collapse of an entire structure or a disproportionately large part of it.” Another definition of collapse by The Centre for the Protection of National Infrastructure (CPNI) provides a useful comparison of the characterization of an event as “progressive” or “disproportionate” in the “*Review of International Research on Structural Robustness and Disproportionate Collapse*” [28] document:

“A *progressive* collapse is one which develops in a progressive manner akin to the collapse of a row of dominoes... The term ‘progressive’ refers to the characteristic of the *behavior* of the structural collapse... A *disproportionate* collapse is one which is judged (by some measure defined by the observer) to be disproportionate to the initial cause. This is a judgment made on the observations of the consequences of the damage which results from the initiating events and does not describe characteristics of the structural behavior... A collapse may be *progressive* in nature but not necessarily *disproportionate* in its extents, for example if arrested after it progresses through a number of structural bays. Vice versa, a collapse may be *disproportionate* but not necessarily *progressive* if, for example, the collapse is limited in its extents to a single structural bay but the structural bays are large.”

These guidelines recognize that under an extreme event some structural damage is often unavoidable – whether it occurs under the initial event – or due to a progressive propagation of the initial damage to adjacent elements due to redistribution of load. For this reason, these Guidelines utilize a definition of collapse that is focused on the relative consequence or extent of damage (i.e. disproportionate), rather than the manner in which that damage occurs (i.e. progressive). In particular, as it relates to the application of these Guidelines to existing buildings, where the implementation of mitigation measures can be significantly more challenging, and a broader definition of collapse is required, this definition allows the acceptance of some level of damage beyond the initial event, when that damage is not considered disproportionate and when it will not lead to instability of the structure.



### C1.2.2 THREAT DEPENDENT APPROACH

Consistent with the new ISC Risk Management Process [26], the focus of these Guidelines is mitigating progressive collapse due to man-made explosive threats only. This is reflected by limiting column removal scenarios to the ground level and high-risk public areas (except for FSL V facilities), where structural elements are most vulnerable to explosive effects due to their proximity to potential vehicle and package threats.

In addition, these Guidelines shall be implemented in coordination with the GSA Applicability document [18], which provides an Alternative Design option for meeting the progressive collapse requirement of the ISC Risk Management Process [26]. The Alternative Design option allows the designer to explicitly design vertical load bearing elements to prevent damage under an initial event, such that loss of a load-bearing element is mitigated and the potential for progressive collapse is significantly reduced. This approach deviates from the previous guidelines, where consideration of progressive collapse was required regardless of the robustness of the structural elements and their susceptibility to failure under any given threat or event. Application of the Alternative Design option shall be in accordance with the GSA Applicability document [18] and is not addressed in these Guidelines.

It is recommended that the engineer work closely with the security consultant at the early stages in the project in order to identify removal scenarios for high-risk spaces, evaluate the feasibility of the Alternate Design option and develop a comprehensive approach to minimizing potential for progressive collapse.

### C1.3 APPLICABILITY

No commentary provided.

### C1.4 HOW TO USE THIS DOCUMENT

This document is intended for designers that have already determined that progressive collapse resistance is required in accordance with the ISC Risk Management Process [26] for the appropriate FSL level. Therefore, while a summary of the process for determining a facility's FSL level is discussed, it is intended as general background only; detailed discussion of the FSL determination process is provided in the ISC Risk Management Process [26]. Similarly, this document is intended for designers that are not utilizing the Alternative Design option for structural hardening in the GSA Applicability [18] document; detailed discussion of the Alternative Design option procedures is provided in Section 7.4 of that document.

### C1.5 DOCUMENT ORGANIZATION

No commentary is provided for this section.

### C1.6 SUMMARY OF THE PROGRESSIVE COLLAPSE DESIGN PROCEDURE

No commentary is provided for this section.





## C2 APPLICABILITY

The application of progressive collapse requirements has been updated from the 2003 GSA Progressive Collapse Analysis and Design Guidelines [27] to be consistent with the ISC Risk Management Process [26]. Under the 2003 guidelines, application of progressive collapse requirements was based primarily on whether the building was 4-stories or greater, with some buildings exempt based on their construction type or function (i.e. Exemption Process). Alternatively, the applicability of these Guidelines is a direct function of the building level of protection, as represented by the Facility Security Level (FSL). While the threshold for which the number of stories triggers progressive collapse is consistent with the intent of the 2003 guidelines [27]; it has been explicitly clarified in order to minimize the misapplication of these Guidelines. It should be noted that the 4-story threshold is a deviation from UFC 04-023-03 [31], which requires consideration of progressive collapse for all buildings 3-stories or greater.

The application of these Guidelines to leased facilities has been updated to specifically address lease facilities. In general, these Guidelines are only applicable to new lease construction or if stated as a tenant specific requirement within the Program of Requirements (POR), these Guidelines may also apply to new lease acquisitions or succeeding leases that are established through full and open competition.

### C2.1 NEW CONSTRUCTION AND BUILDING ADDITIONS

The applicability of these Guidelines on building additions is based on the physical security requirements in the ISC Risk Management Process [26] which requires all new additions be designed to meet the same standards, regardless of size, as new construction. This requirement does not apply to the existing portion of the building unless the new addition is 50% or more of the gross area of the existing building and existing portion is undergoing a major structural renovation. If required, the existing portion of the building shall be evaluated for the provisions of these Guidelines applicable to existing buildings.

### C2.2 NEW VS. EXISTING CONSTRUCTION

The application of these Guidelines for new vs. existing construction deviates from the previous guidelines, which required consistent application of progressive collapse requirements regardless of construction type. For existing buildings, where the cost and constructability of bringing an existing structure to meet these Guidelines may be impractical, these Guidelines adopt the decision-making methodology from the ISC Risk Management Process [26]. Under this methodology, the decision to either implement mitigation measures or accept risk is that of the Government. It is the responsibility of the Design Team to provide the Government all information pertinent to making an informed risk-based decision, including the specific vulnerabilities that must be addressed, a complete understanding of potential consequences and the associated costs. In some cases, investment in an expensive countermeasure may not be advisable because the lifecycle of the asset is almost expired. Alternatively, in some cases implementation of mitigation measures may be constrained not only by cost but also by physical and operational aspects of the existing facility. For new construction, application of these Guidelines is required in their entirety.



### C2.3 FACILITY SECURITY LEVELS (FSL)

These guidelines apply to FSL III, IV and V only. For FSL III & IV, both the alternate path and redundancy requirements are applied. For FSL V facilities, only the alternate path requirements need to be applied. This is because Section 3.2.9 requires all FSL V buildings to consider removal scenarios up the entire height of the building. This will result in a design that inherently meets the intent of the redundancy requirements and no additional calculations are required.



## C3 DESIGN PROCEDURES

### C3.1 TIE FORCES

These Guidelines do not adopt the Tie Force methodology of the UFC 04-023-03 [31]. The UFC 04-023-03 [31] utilizes the Tie Force procedure for two different building types: 1) for low occupancy buildings (i.e. OC II) as an alternative to performing an Alternate Path analysis and 2) for high occupancy buildings (i.e. OC IV), where Tie Forces are required in addition to the Alternate Path in order to provide another layer of resistance to collapse and supplement the flexural resistance developed in the Alternate Path method.

Consistent with the progressive collapse requirements of Appendix B of the ISC Risk Management Process [26], these Guidelines require explicit design for loss of vertical load-bearing elements through the Alternative Path and do not allow use of the Tie Force method as an alternative approach for providing progressive collapse resistance, regardless of occupancy. For higher level of protection buildings, such as FSL V, removal scenarios are considered at all column/load-bearing wall locations (i.e. interior/exterior and all levels) as part of the Alternate Path method, which demonstrates the ability of the structure to bridge over loss of any element. Based on this level of robustness already incorporated into the design, the addition of Tie Forces was deemed superfluous. Another consideration in removing the Tie Force methodology from these Guidelines is the difficulty in its implementation in existing buildings and some types of new load-bearing wall construction.

### C3.2 ALTERNATE PATH METHOD

#### C3.2.1 GENERAL

In the Alternate Path (AP) method, the designer must show that the structure is capable of bridging over a removed column or section of wall and that the resulting deformations and internal actions do not exceed the acceptance criteria. Three analysis procedures are permitted: Linear Static, Nonlinear Static, and Nonlinear Dynamic.

An assessment of analysis methods in the related field of seismic design revealed that the procedures specified in ASCE 41 *Seismic Rehabilitation of Existing Buildings* [10] could be adopted and modified for application in progressive collapse design. While progressive collapse design and seismic design are distinctly different, the general ASCE 41 [10] approach was adopted for the following reasons:

- ASCE 41 [10] and progressive collapse guidelines deal with extreme events that severely damage structures which must not collapse or otherwise imperil the occupants.
- The ASCE 41 [10] methodology was developed and vetted by a panel of structural engineering experts over many years of effort and could be modified in a straightforward manner for progressive collapse design.
- Explicit requirements and guidance for analyzing and designing multiple building types for various materials are provided in ASCE 41 [10].
- Careful attention is given in ASCE 41 [10] to deformation- and force-controlled actions, as well as primary and secondary components.



- The acceptance criteria and modeling parameters in ASCE 41 [10] can be scaled for different structural performance levels.

The most significant differences between the physics, intent, and approaches underlying these guidelines and ASCE 41 [10] are:

- **Extent.** The seismic event involves the entire structure, whereas, for progressive collapse, the initial event is localized to the column/wall removal area.
- **Load Types.** Seismic loads are horizontal and temporary; for progressive collapse, the loads are vertical and permanent.
- **Damage Distribution.** For earthquake design, it is accepted that the damage will be distributed throughout the structure. For progressive collapse, the initial damage is localized and the goal is to keep the damage from propagating to a more global level that may result in structural instability.
- **Connection and Member Response.** In typical tests to evaluate the seismic performance of connections and members, cyclic loads with increasing magnitude are applied, without axial loading, and the resulting curves are used to develop “backbone” curves. In progressive collapse, the connection and member experiences one half cycle of loading, often in conjunction with a significant axial load, due to large deformations and catenary response.

These differences have been accommodated in the adaptation of ASCE 41 [10] procedures and criteria to Alternate Path modeling and design for progressive collapse. The significant elements of the Alternate Path method are presented in the following paragraphs.

### C3.2.2 ALTERNATIVE RATIONAL ANALYSIS

The intent of this section is to provide the designer with the flexibility to utilize rational alternative analysis procedures to demonstrate compliance with the performance objectives of these Guidelines. Alternative analysis procedures shall be based on fundamental principles of engineering mechanics and dynamics. At the most basic level, an alternative analysis procedure may include use of a two-dimensional model, hand calculations or spreadsheet applications for simple structures. Additionally, modeling and acceptance criteria contained in these Guidelines must be incorporated in the analysis, including the following:

- Acceptance criteria contained in Section 3.2.10 and in Chapters 4 through 8.
- Specified locations and sizes of removed columns and load-bearing walls in Section 3.2.9.
- Load combinations in Section 3.2.11.4.
- Load increase factors and dynamic increase factors in Sections 3.2.11.5 and 3.2.12.5 for linear static and nonlinear static analyses, respectively.
- Requirements of Section 3.2.11.1 must be met for a Linear Static analysis.

For these types of analysis, where the above items are incorporated or satisfied, approval of methodology by the Government prior to the start of work is not required; however, final analysis results shall be reviewed by an independent third-party engineer or by an authorized representative of the Government.



Where alternative analysis procedures deviate from any of the above, including, but not limited to the alternative analysis procedure outlined in 3.2.10.2 for existing buildings, the proposed alternative rational analysis methodology shall be submitted to and approved by the Government for review and approval prior to start of work and final analysis results shall be reviewed by an independent third-party engineer or by an authorized representative of the Government.

Peer reviews outside of the situations identified above may be required at the discretion of the Government based on project specific conditions and are in general recommended for existing buildings and buildings where the non-linear dynamic analysis procedure is used.

### C3.2.3 LOAD AND RESISTANCE FACTOR DESIGN

Load and Resistance Factor Design (LRFD) is used in these Guidelines and a modified ASCE 7 [9] extraordinary event load combination is employed. Unlike ASCE 41 [10], strength reduction factors are employed in determining the design strength for all components, including connections. The strength reduction factors account for deficient material strength, construction errors, design flaws and other uncertainties that can act to reduce the strength of the building; all of these uncertainties are “locked” into the building when it is constructed and will still be there when a progressive collapse event occurs. Therefore, the strength reduction factors, load factors, and the LRFD approach are employed in these Guidelines.

### C3.2.4 PRIMARY AND SECONDARY COMPONENTS

The designation of elements, components and connections as primary or secondary is left to the judgment of the engineer; however, in all cases, the engineer must verify that the structure and its elements, components and connections are capable of meeting the structural acceptance criteria in Paragraph 3.2.10.

For evaluation of existing buildings, the engineer may wish to include elements that are typically considered secondary (i.e., gravity beams, slabs, infill walls, etc.) to fully take advantage of the available strength and load redistributing capability of the existing structural system (i.e. catenary action). If such elements are included as part of the vertical load redistribution system, they become primary components by definition and must meet the primary component acceptance criteria.

#### C3.2.4.1 SECONDARY COMPONENTS

While secondary components are designated by the engineer as not contributing to the resistance of gravity loads and progressive collapse, they are a critical part of the load path for vertical loads and may pose a risk to building occupants if they drop into the space below, potentially creating additional damage and collapse. As an example, the gravity beams in a bay supporting heavy mechanical equipment could be treated as secondary components; however, the shear tab connections with a deep bolt group could have reduced allowable rotations/m-factors such that the rotations from the column removal could be sufficient to fail the shear tab connections.

Secondary components need not be included as part of the models in the linear or nonlinear procedures but must be checked against enforced deformations under the removal scenarios and acceptance criteria



given in these Guidelines and in ASCE 41 [10]. This can be achieved by simple hand calculations using deflections determined from the model.

#### C3.2.5 FORCE-AND DEFORMATION-CONTROLLED ACTIONS

No commentary is provided for this section.

#### C3.2.6 EXPECTED AND LOWER BOUND STRENGTH

No commentary is provided for this section.

#### C3.2.7 MATERIAL PROPERTIES

No commentary is provided for this section.

#### C3.2.8 COMPONENT FORCE AND DEFORMATION CAPACITIES

No commentary is provided for this section.

#### C3.2.9 REMOVAL OF LOAD BEARING ELEMENTS FOR ALTERNATE PATH METHOD

Consistent with the new Risk Management Process standards, the focus of these Guidelines is mitigating progressive collapse due to man-made explosive threats only. This is reflected by limiting column removal scenarios to the ground level and high-risk public areas (except for FSL V facilities), where structural elements are most vulnerable to explosive effects due to their proximity to potential vehicle and package threats.

For high-risk public areas, all load-bearing walls/columns that are exposed to potential air-blast loads due to the detonation of an interior threat shall be considered for removal, including those within adjacent controlled spaces that are open and not protected by interior walls. In addition, if there are multiple levels of uncontrolled access (e.g. multiple levels of parking), column removal shall be considered at each level.

#### C3.2.10 STRUCTURE ACCEPTANCE CRITERIA

With a few notable exceptions, the acceptance criteria for linear and nonlinear approaches and the modeling criteria for nonlinear approaches from ASCE 41 [10] are employed. The ASCE 41 [10] criteria are considered to be conservative when applied to progressive collapse design as they were developed for repeated load cycles (i.e., backbone curves) whereas only a one half load cycle is applied in progressive collapse. As specified in each material specific chapter of this document, either the Collapse Prevention or Life Safety performance levels in ASCE 41 [10] are used for many of the components.

The notable exceptions/modifications to the acceptance and modeling criteria include RC beams and slabs and a number of steel connections. These changes are motivated and justified by experimental data and numerical analysis results, which are discussed further in Paragraphs C4.4.3 and C5.4.3.



### C3.2.10.1 COLLAPSE PREVENTION

These Guidelines adopt Collapse Prevention modeling and acceptance criteria for reinforced concrete and structural steel elements only. In accordance with ASCE 41 [10] Table C1-2 and Section C1.5.1.5, Collapse Prevention can be characterized by the following expected performance level:

- Overall Damage: Severe. Little residual stiffness and strength, but load-bearing columns and walls function. Building is near collapse. All significant components of the gravity-load-resisting system continue to carry their gravity loads. The structure may not be technically practical to repair and is not safe for reoccupancy.

While this level of damage is recognized as severe, it should be emphasized that the design objective for progressive collapse resistance is to mitigate the propagation of damage to a disproportionate extent such that structural instability will not occur and emergency evacuation procedures can be implemented. The objective is not for the building to remain operational or for the damage to be economically repairable. Based on this definition and available test data that demonstrates the ability of reinforced concrete and structural steel elements to accommodate large plastic rotations, the use of Collapse Prevention is considered appropriate for reinforced concrete and structural steel elements.

### C3.2.10.2 ALLOWABLE EXTENTS OF COLLAPSE

The previous GSA Guidelines accepted allowable extents of collapse resulting from removal of a vertical load-bearing element for both new and existing buildings. The extent of collapse was defined as the structural bays directly associated with the removed element at the floor level directly above the element, not to exceed 1,800-ft<sup>2</sup> or 3600-ft<sup>2</sup> for exterior and interior removal scenarios respectively. Previous versions of the UFC adopted a similar approach, with the allowable extent of collapse limited to 15% and 30% of the floor area above the removed element for exterior and interior removal scenarios respectively. The most recent version of the UFC, however, removed any allowance of collapsed area, requiring that all elements, including those directly above the removed element, be designed to meet the defined acceptance criteria.

These guidelines recognize that under an extreme event some structural damage is often unavoidable – whether it occurs under the initial event – or due to a progressive propagation of the initial damage to adjacent elements due to redistribution of load. For this reason, these Guidelines utilize a definition of collapse that is focused on the relative consequence or extent of damage (i.e. disproportionate), rather than the manner in which that damage occurs (i.e. progressive). In particular, as it relates to the application of these Guidelines to existing buildings, where the implementation of mitigation measures can be significantly more challenging, and a broader definition of collapse is required. This definition allows the acceptance of some level of damage beyond the initial event, when that damage is not considered disproportionate and when it will not lead to instability of the structure. The definition of “disproportionate” is taken similar to that utilized in the previous UFC, where an extent of collapse is allowed at structural bays on either side of and at the floor level above the removed element.

### C3.2.11 LINEAR STATIC PROCEDURE

The Linear Static approach utilizes an “m-factor” procedure, very similar to that defined in ASCE 41 [10]. The two significant departures from the ASCE 41 [10] procedure are in the definition of the “Irregularity



Limitations” in Paragraph 3.2.11.1.1 and the use of a dynamic load increase factor appropriate for a progressive collapse event. The irregularity limitations have been adjusted due to the inherent difference between lateral/seismic loading and vertical/progressive collapse loading and the related criticality of different building geometric and strength features. As discussed in Section 3.2.12.4, a load increase factor to account for nonlinearity and dynamic effects has been implemented.

#### C3.2.11.1 LIMITATIONS ON THE USE OF LSP

No commentary is provided for this section.

#### C3.2.11.2 ANALYTICAL MODELING

No commentary is provided for this section.

#### C3.2.11.3 STABILITY/P- $\Delta$ EFFECTS

No commentary is provided for this section.

#### C3.2.11.4 LOADING

The ASCE 7 [9] extraordinary event load combination is employed, with the exception that the lateral load has been removed and the 0.9 factor on the dead load has been removed. In Alternate Path analyses, the initial and primary damage is limited to the column or removal location, with the rest of the structure being intact and providing the majority of its original lateral load resistance. It is highly unlikely that the loss of a column or 2H wall section would destabilize the building laterally; therefore the lateral load requirement has been removed.

#### C3.2.11.5 LOAD INCREASE FACTOR

As progressive collapse is a dynamic and nonlinear event, the applied load cases for the static procedures require the use of load increase factors or dynamic increase factors, which approximates inertial and nonlinear effects. For both Linear Static and Nonlinear Static, the previous GSA Guidelines used a load multiplier of 2.0, applied directly to the progressive collapse load combination; however based on a study performed during the development of the UFC 4-023-03 [31] modifications to the load increase factor were made for deformation-controlled actions.

It should be noted that the dynamic increase factors addressed above shall not be confused with the dynamic increase factors typically used in non-linear dynamic analysis of components for blast loads, where the strength of a material is multiplied by a dynamic increase factor to account for strain rate effects. These are two different factors that address different phenomena; the dynamic increase factors discussed related to strain rate effects are not applicable to progressive collapse load scenarios.

#### C3.2.11.6 DESIGN FORCES AND DEFORMATIONS

No commentary is provided for this section.



### C3.2.11.7 COMPONENT AND ELEMENT ACCEPTANCE CRITERIA

For linear procedures, evaluation of secondary components must meet both the force- and deformation-controlled criteria of Equation 3.6 and Equation 3.7. Under conventional loading conditions, before the column or wall is removed, the secondary component will be initially stressed and deformed due to the deformation-controlled or force-controlled load combinations given in Equation 3.3 and Equation 3.4 respectively. When the column or wall is removed, additional stresses and deformations are created. As a linear static procedure is being used, these two sets of demands can be superimposed and directly added. This can be achieved by performing the following steps for each secondary component or connection:

- 1) Evaluate the demand (internal shear, moment, axial force) due to the force- or deformation controlled load case under the structure's undeformed configuration (i.e. prior to column/wall removal).
- 2) Evaluate the demand (internal shear, moment, axial force) due to the enforced displacements and rotations under the structure's deformed configuration (i.e. post column/wall removal). The demand resulting from the enforced displacements and rotations can be calculated using approximation rotation stiffness and simple beam-end moment equations, as shown in Appendix D and Appendix E.
- 3) The two demand from Steps 1 and 2 can be combined together to determine the total demand.

Acceptance checks of gravity beams and simple shear tab connections (secondary components) in steel frame structures present a unique challenge. The linear static procedure and criteria are based on  $m$ -factors applied to the moments and other deformation-controlled actions; therefore acceptance criteria must be based on moments, shears, and other forces. This requires that moments be calculated even at the simple connections and the ends of gravity beams, which are often considered to be pinned.

As shown in Appendix E, simple shear tab connections can be considered partially restrained (PR) connections and their flexural strength calculated using an approximate rotational stiffness for comparison to the flexural demand. Similar approaches must be devised and used for reinforced concrete, masonry, wood, and cold-formed steel structures.

### C3.2.12 NONLINEAR STATIC PROCEDURE

The Nonlinear Static procedure is similar to that specified in the ASCE 41 [10]. One advantage of ASCE 41 [10] is that guidance is provided for the development of analytical and numerical models for a number of distinct structural systems, including the determination of connection and member properties.

One significant difference from ASCE 41 [10] and this document is the specification of a dynamic increase factor that is applied to the loads on the bays above the removed column or wall location to account for dynamic effects. In the 2003 GSA Guidelines [27], the load factor was set at 2, as for the Linear Static analysis, despite the explicit incorporation of nonlinear effects in the Nonlinear Static procedure. The dynamic increase factor is discussed in Section C3.2.12.5.

#### C3.2.12.1 LIMITATIONS ON THE USE OF NLSP

No commentary is provided for this section.



#### C3.2.12.2 ANALYTICAL MODELING

No commentary is provided for this section.

#### C3.2.12.3 STABILITY/P- $\Delta$ EFFECTS

No commentary is provided for this section.

#### C3.2.12.4 LOADING

No commentary is provided for this section.

#### C3.2.12.5 DYNAMIC INCREASE FACTOR FOR NSP

As discussed in Section C3.2.11.5, progressive collapse is a dynamic and nonlinear event and the applied load cases for the static procedures require the use of load increase factors or dynamic increase factors, which approximately account for inertial and nonlinear effects. Similar to Linear Static, the previous GSA Guidelines [27] used a load multiplier of 2.0 for Nonlinear Static analysis, applied directly to the progressive collapse load combination. Based on a study performed during the development of the UFC [31] modifications to the dynamic increase factors for steel and concrete frames are used in these Guidelines, which are now a function of the allowable plastic rotation and element yield rotation.

It should be noted that the dynamic increase factors addressed above shall not be confused with the same as the dynamic increase factors typically used in non-linear dynamic analysis of components for blast loads, where the strength of a material is multiplied by a dynamic increase factor to account for strain rate effects. These are two different factors that address different phenomena; the dynamic increase factors discussed related to strain rate effects are not applicable to progressive collapse load scenarios.

#### C3.2.12.6 DESIGN FORCES AND DEFORMATION

No commentary is provided for this section.

#### C3.2.12.7 COMPONENT AND ELEMENT ACCEPTANCE CRITERIA

No commentary is provided for this section.

#### C3.2.13 NONLINEAR DYNAMIC PROCEDURE

The Nonlinear Dynamic procedure utilized in these Guidelines is essentially unchanged from the UFC.

### C3.3 ~~ENHANCED LOCAL RESISTANCE~~

No commentary is provided for this section.



## C3.4 REDUNDANCY REQUIREMENTS

In addition to addressing the explicit need for a structure to be capable of bridging over the loss of a vertical load-bearing element under a blast event, the overall objective of these Guidelines is to provide robust structures that provide some level of redundancy and load-redistribution capability under any extreme event (i.e. fire, impact, construction error, etc.). Structural designs where progressive collapse resistance is localized to one floor level such as a single ring girder or truss system do not meet this objective, as their failure, or failure of load-bearing elements above them, could potentially result in a catastrophic failure.

Based on this objective, the redundancy requirements were developed to ensure some level of redundancy is provided up the height of the building and to provide an overall more robust and resilient structure. The intent is that their application be simple in nature, without the need for an exhaustive or time-intensive analysis. Further, the goal of these requirements is that they can be incorporated into an integrated and complimentary system that meets the performance needs of all other loading conditions. In particular, enforcement of this requirement shall not defeat the achievement of a properly distributed lateral force system.

Strength and stiffness were chosen as the measures by which to compare the distribution of load redistribution systems up the height of the building due to their simplicity in calculation and familiarity in the general structural engineering and seismic community. It is recognized that these measures alone do not capture the dynamic behavior of the structure under an extreme event or the level of ductility provided by the structural elements and their connections. Therefore, it is emphasized that these requirements are to be applied in conjunction with the Alternate Path requirements and are not to be misconstrued as a substitute for column removal scenarios up the height of the building where required (i.e. FSL V facilities). Further, these requirements shall be implemented alongside ductile detailing requirements in both the GSA Applicability document [18] and all applicable design codes.

### C3.4.1 LOCATION REQUIREMENTS

No commentary is provided for this section.

### C3.4.2 STRENGTH REQUIREMENTS

The extent of structural elements that is included in the calculation of a load-redistributing system's strength is defined as the horizontal elements associated with the removal scenario under consideration. For columns, this is relatively straightforward and is typically defined as all beam elements tying into the column plan location at each load-redistributing level. For load-bearing walls, it will typically be defined as horizontal elements at each load-redistributing level that span over the extent of removed wall element (i.e. "H"), such as perimeter edge beams or walls at the floor above that as spandrel elements.

For most typical conditions where slab type (i.e. material) and thickness does not significantly vary, the relative strength contribution of slabs at each load-redistribution level will be minor. Therefore, in general, the inclusion of slabs in redundancy calculations will have a negligible effect and need not be included. However, where the slab design does change significantly between floor levels, the relative contribution of slabs shall be included.



### C3.4.3 STIFFNESS REQUIREMENTS

Consistent with the commentary provided in C3.4.2 for strength, the extent of structural elements that is included in the calculation of a load-redistributing system's stiffness is defined as the horizontal elements associated with the removal scenario under consideration. For columns, this is relatively straightforward and is typically defined as all beam elements tying into the column plan location at each load-redistributing level. For load-bearing walls, it will typically be defined as horizontal elements at each load-redistributing level that span over the extent of removed wall element (i.e. "H"), such as perimeter edge beams or walls at the floor above that as spandrel elements.

For most typical conditions where slab type (i.e. material) and thickness does not significantly vary, the relative strength contribution of slabs at each load-redistribution level will be minor. Therefore, in general, the inclusion of slabs in redundancy calculations will have a negligible effect and need not be included. However, where the slab design does change significantly between floor levels, the relative contribution of slabs shall be included.

## C4 REINFORCED CONCRETE

### C4.1 MATERIAL PROPERTIES FOR REINFORCED CONCRETE

No commentary is provided for this section.

### C4.2 STRENGTH REDUCTION FACTOR $\phi$ FOR REINFORCED CONCRETE

No commentary is provided for this section.

### C4.3 ~~TIE FORCE REQUIREMENTS FOR REINFORCED CONCRETE~~

No commentary is provided for this section.

### C4.4 ALTERNATE PATH REQUIREMENTS FOR REINFORCED CONCRETE

For new and existing construction, the design strength and rotational capacities of the beams and beam-to-column joints shall be determined with the guidance found in ASCE 41 [10].

#### C4.4.1 GENERAL

No commentary is provided for this section.

#### C4.4.2 FLEXURAL MEMBERS AND JOINTS

No commentary is provided for this section.

#### C4.4.3 MODELING AND ACCEPTANCE CRITERIA FOR REINFORCED CONCRETE

In general, these Guidelines utilize the modeling and acceptance criteria for reinforced concrete provided in ASCE 41 [10] for Collapse Prevention. The only exceptions are for those elements where sufficient



research has been developed to demonstrate increased performance limits, such as those provided in the replacement tables in the UFC. Modifications to the modeling and acceptance criteria for beams and slabs were made based on data from blast- and impact-loaded beams and other flexural members. For RC beams and slabs controlled by flexure, the modeling and acceptance criteria values for Collapse Prevention were multiplied by a factor of 2.5 for primary members and 2.0 for secondary members.

#### BEST PRACTICE RECOMMENDATION

To insure ductile and energy absorbing response in new construction of reinforced concrete structures, it is recommended that the primary reinforced concrete beams and beam-to-column-to-beam joints comply with the provisions for special moment frames in ACI 318 [3]. These code provisions include ductile detailing requirements for longitudinal reinforcement, transverse reinforcement, required shear strength, and development length of bars in tension.

#### ~~C4.5 ENHANCED LOCAL RESISTANCE FOR REINFORCED CONCRETE~~

No commentary is provided for this section.

### C5 STRUCTURAL STEEL

#### C5.1 MATERIAL PROPERTIES FOR STRUCTURAL STEEL

No commentary is provided for this section.

#### C5.2 STRENGTH REDUCTION FACTOR $\phi$ FOR STRUCTURAL STEEL

No commentary is provided for this section.

#### ~~C5.3 TIE FORCE REQUIREMENTS FOR STEEL~~

No commentary is provided for this section.

#### C5.4 ALTERNATE PATH METHOD FOR STEEL

For new and existing construction, the design strength and rotational capacities of the beams and beam-to-column connections shall be determined with the guidance found in ASCE 41 [10], as modified with the acceptance criteria provided in Section 5.4.3 of this document.

##### C5.4.1 GENERAL

No commentary is provided for this section.

##### C5.4.2 CONNECTION ROTATIONAL CAPACITY

No commentary is provided for this section.



### C5.4.3 MODELING AND ACCEPTANCE CRITERIA FOR STRUCTURAL STEEL

In general, these Guidelines utilize the modeling and acceptance criteria for structural steel provided in ASCE 41 [10] for Collapse Prevention. The only exceptions are for those elements where sufficient research has been developed to demonstrate increased performance limits, such as those provided in the replacement tables in the UFC. In some cases, where little or no criteria were available, new acceptance criteria were created, using the existing literature and recent tests and numerical simulations, as detailed in *Engineering Analysis and Guidance for Structural Steel Issues in Progressive Collapse, Tasks 5.7 and 5.19*, Karns and Houghton, 2008 [14].

Modifications to the modeling and acceptance criteria in the UFC [31] were based on a comparison between the deformation limits contained in ASCE 41 [10], the Eurocode, and the 2005 UFC. These limits were also compared to the rotational capacities reported in the *GSA Steel Frame Bomb Blast and Progressive Collapse Test Program Report* ("GSA Test Program Report") [19] as summarized in Karns and Houghton 2008 [14]. The progressive collapse test configurations in the GSA Test Program [19] were designed to capture both bending and axial tension to determine the effect of their interaction on the rotational capacity of the connection investigated.

#### BEST PRACTICE RECOMMENDATION

For new construction, it is recommended that all primary steel frame beam-to-column moment connections be one of the special moment frame (SMF) connections identified in FEMA 350 [15] under Section 3.5 (welded), Section 3.6 (bolted) or Section 3.8 (proprietary), and/or ANSI/AISC 358 (including Supplements) *Prequalified Connections for Special and Intermediate Steel Moment Frames for Seismic Applications* [35], and/or prequalified under *ICC-ES AC129 Steel Moment Frame Connection Systems* [36]. The use of an SMF connection type should not be construed to include all SMF seismic detailing provisions specified in national building codes for higher seismic regions, except for the case where a particular building design is subject to those code provisions.

The additional cost for SMF connections should be minimal, as the use of notch-tough weld wire, continuity plates, and high strength bolts, etc., is common practice. The primary reason for using an SMF connection is to secure the connection characteristics that provide a minimum threshold of rotational capacity. It is important to note that the "seismic detailing" provisions of the IBC Building Code [20] in their entirety are not required for progressive collapse design applications, unless the seismic region for a particular building design is subject to those earthquake code provisions anyway.

Acceptable SMF-type connections include:

- Welded Unreinforced Flanges with Welded Web (WUF-W)
- Bolted Flange Plate (BFP)
- Bolted Unstiffened End Plate (BUFP)
- Bolted Stiffened End Plate (BSEP)
- Reduced Beam section (RBS)
- Kaiser Bolted Bracket®
- SidePlate®
- Slotted Web™

Two common connections that do not meet the SMF requirements are:



- Double Split Tee (DST)
- Welded Unreinforced Flanges with Bolted Web (WUF-B).
- For the WUF-B connection, welding of its bolted web-to-shear tab connection is all that is required for it to become a WUF-W connection, for which there is a significant improvement in rotational performance, including increased reliability.

A list of a variety of steel frame connection types are listed in Table C1.1 and illustrated in Figures C-8 through C-10. This list constitutes an inventory of connection types that have been used either in the past and/or present for standard building code design applications (gravity, wind and earthquake loads).

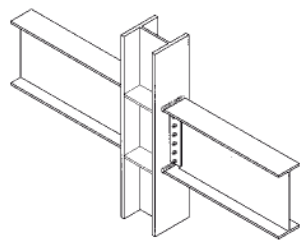
Propriety connections have been evaluated and found to be acceptable for use on specific projects and/or for general application in providing progressive collapse resistance. Inclusion of these connections in this document does not constitute an endorsement. The Kaiser Bolted Bracket®, SidePlate®, and SlottedWeb™ are shown schematically in Figures C1.1 through C1.6, respectively. Details of the performance and geometry can be obtained from the vendors.



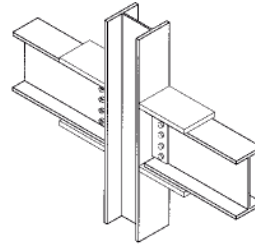
**Table C1.1. Steel Frame Beam-to-Column Connection Types**

Connection	Description	Type	Figure
Welded Unreinforced Flange (WUF)	Full-penetration welds between beams and columns, flanges, bolted or welded web, designed prior to code changes following the Northridge earthquake.	FR	C1.1(a)
Welded Flange Plates (WFP)	Flange plate with full-penetration weld at column and fillet welded to beam flange	FR	C1.1 (b)
Welded Cover-Plated Flanges	Beam flange and cover-plate are welded to column flange	FR	C1.1 (c)
Bolted Flange Plates (BFP)	Flange plate with full-penetration weld at column and field bolted to beam flange	FR or PR	C1.1 (d)
Improved WUF-Bolted Web(1)	Full-penetration welds between beam and column flanges, bolted web, developed after Northridge Earthquake	FR	C1.1 (a)
Improved WUF-Welded Web	Full-penetration welds between beam and column flanges, welded web developed after Northridge Earthquake	FR	C1.1 (a)
Free Flange	Web is coped at ends of beam to separate flanges, welded web tab resists shear and bending moment due to eccentricity due to coped web developed after Northridge Earthquake	FR	C1.1 (e)
Welded Top and Bottom Haunches	Haunched connection at top and bottom flanges developed after Northridge Earthquake	FR	C1.1 (f)
Reduced Beam Section (RBS) (2)	Connection in which net area of beam flange is reduced to force plastic hinging away from column face developed after Northridge Earthquake	FR	C1.1 (g)
Top and Bottom Clip Angles	Clip angle bolted or riveted to beam flange and column flange	PR	C1.2 (a)
Bolted Double Split Tee(2)	Split tees bolted or riveted to beam flange and column flange	PR	C1.2 (b)
Composite Top and Clip Angle Bottom	Clip angle bolted or riveted to column flange and beam bottom flange with composite slab	PR	C1.2 (a) similar
Bolted Flange Plates	Flange plate with full-penetration weld at column and bolted to beam flange	PR	C1.1 (d)
Bolted End Plate	Stiffened or unstiffened end plate welded to beam and bolted to column flange	PR	C1.2 (c)
Shear Tab Connection with or without(2) floor deck	Simple gravity connection with shear tab, may have composite floor deck	PR	C1.3 (b)
Kaiser Bolted Bracket®	SMF moment connection with fastened cast steel haunch brackets that are bolted to the column flange and either fillet-welded or bolted to both beam flanges.	FR	C1.4
SidePlate®	SMF moment connection with full-depth side plates and fillet welds, developed following the 1994 Northridge earthquake	FR	C1.5
SlottedWeb™	SMF moment connection similar to WUF with extended web slots at weld access holes to separating the beam flanges from the beam web in the region of the connection.	FR	C1.6

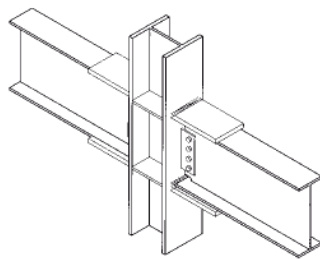




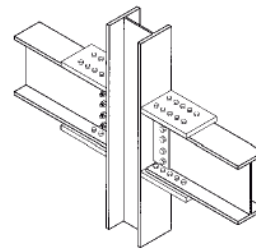
(a) WUF Connection



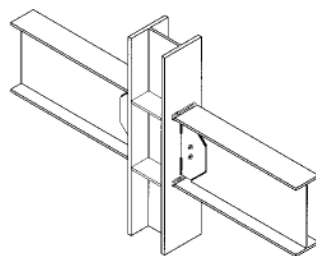
(b) Welded Flange Plate



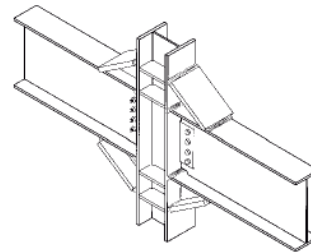
(c) Welded Cover Plated Flanges



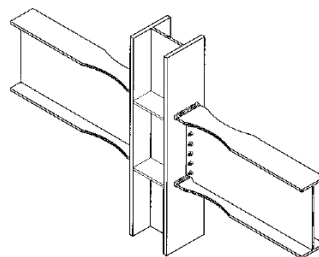
(d) Bolted Flange Plate



(e) Free Flange

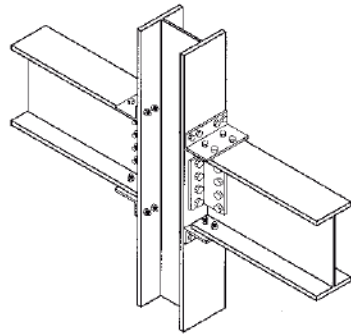


(f) Top and Bottom Haunch

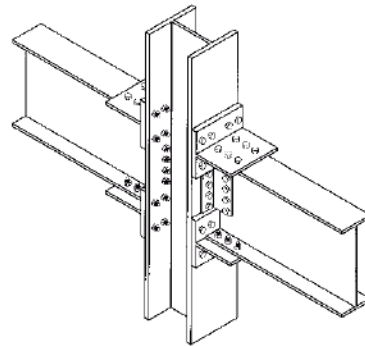


(g) Reduced Beam Section (RBS)

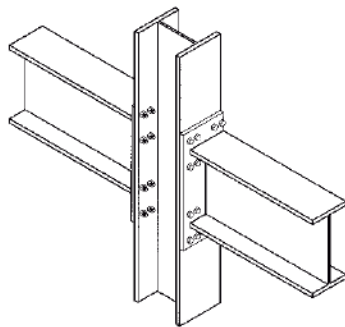
**Figure C1.1. Fully Restrained Moment Connections or Shear Connections**



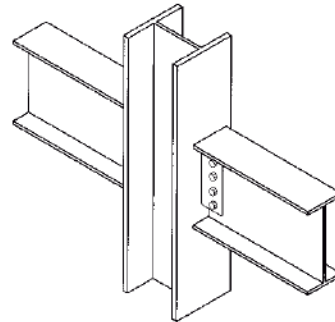
(a) Bolted or Riveted Angle



(b) Bolted Double Split Tee

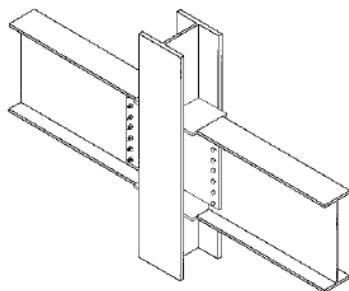


(c) End Plate (Unstiffened)

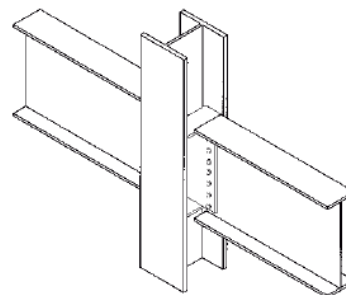


(d) Simple Shear Tab Connection

**Figure C1.2. Partially Restrained Moment Connections or Shear Connections**

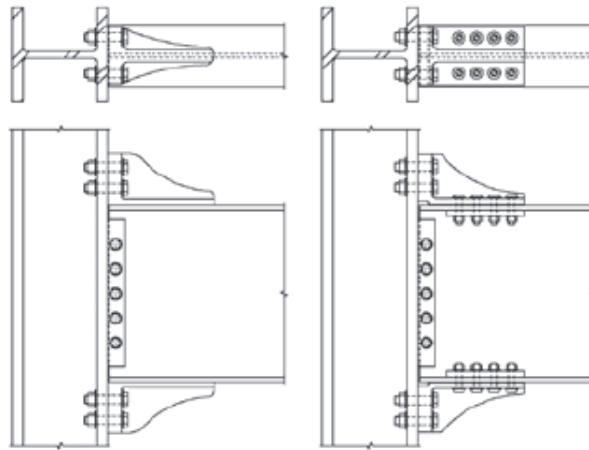


(a) Fully Restrained Connection

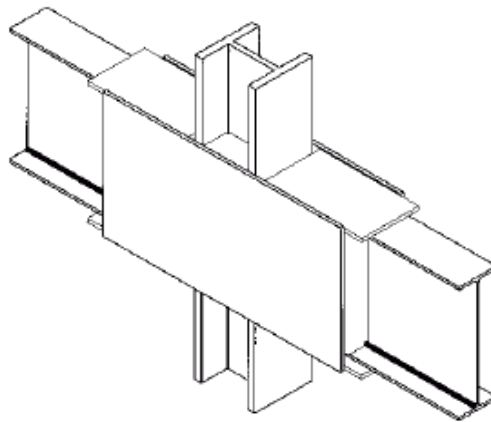


(b) Typical Shear Only Connection

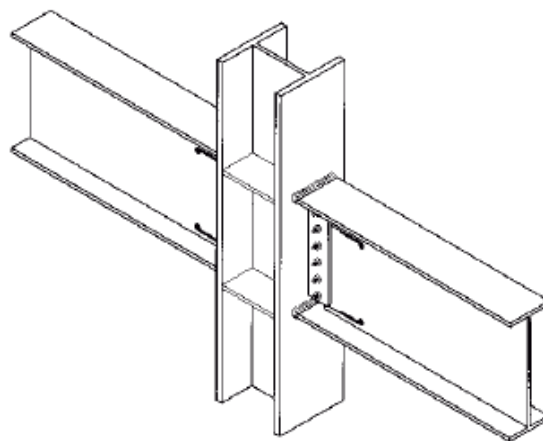
**Figure C1.3. Weak Axis Moment Connection or Shear Connection**



**Figure C1.4. Kaiser Bolted Bracket® Fully Restrained Connection**



**Figure C1.5. SidePlate® Fully Restrained Connection**



**Figure C1.6. SlottedWeb™ Fully Restrained Connection**



## C6 MASONRY

Due to the lack of available testing supporting the change to Collapse Prevention, modeling parameters, nonlinear acceptance criteria and linear m-factors for the Life Safety performance level in ASCE 41 [10] are utilized for Alternate Path analysis and design of masonry structures.

## C7 WOOD

Due to the lack of available testing supporting the change to Collapse Prevention, modeling parameters, nonlinear acceptance criteria and linear m-factors for the Life Safety performance level in ASCE 41 [10] are utilized for Alternate Path analysis and design of wood structures.

## C8 COLD-FORMED STEEL

Due to the lack of available testing supporting the change to Collapse Prevention, modeling parameters, nonlinear acceptance criteria and linear m-factors for the Life Safety performance level in ASCE 41 [10] are utilized for Alternate Path analysis and design of cold-formed structures.



# **APPENDIX D**

## **REINFORCED CONCRETE EXAMPLE**

---



## TABLE OF CONTENTS

<b>D1 INTRODUCTION .....</b>	<b>D1</b>
<b>D2 BASELINE PRELIMINARY DESIGN .....</b>	<b>D1</b>
D2.1 DESIGN AND MODELING ASSUMPTIONS.....	D1
D2.1.1 CONNECTIONS.....	D1
D2.1.2 ELEMENTS.....	D1
D2.1.3 LOADING .....	D1
D2.1.4 MEMBER SIZES.....	D2
<b>D3 LINEAR STATIC PROCEDURE.....</b>	<b>D9</b>
D3.1 DCR AND IRREGULARITY CHECK .....	D9
D3.2 COLUMN REMOVAL LOCATIONS.....	D9
D3.3 ANALYTICAL MODELING.....	D10
D3.3.1 PRIMARY AND SECONDARY ELEMENT CLASSIFICATION .....	D10
D3.3.2 CLASSIFICATION OF DEFORMATION AND FORCE-CONTROLLED ACTIONS.....	D10
D3.3.3 M-FACTORS.....	D11
D3.3.3.1 TYPICAL BEAM COMPONENT .....	D11
D3.3.3.2 BEAM COLUMN JOINT .....	D13
D3.3.3.3 COLUMN.....	D13
D3.3.4 LOAD INCREASE FACTORS .....	D20
D3.3.5 LOAD COMBINATIONS.....	D20
<b>D4 ALTERNATIVE PATH ANALYSIS .....</b>	<b>D21</b>
D4.1 DEVELOP PRELIMINARY MODEL .....	D21
D4.2 DEFINE LOAD CASES AND ASSIGN LOADS.....	D22
D4.3 RUN ANALYSIS AND COMPARE TO ACCEPTANCE CRITERIA .....	D24
D4.3.1 SECONDARY COMPONENT CHECKS .....	D41
<b>D5 REDUNDANCY REQUIREMENTS.....</b>	<b>D48</b>
D5.1 LOCATION REQUIREMENTS .....	D48
D5.2 STRENGTH REQUIREMENTS.....	D48
D5.2.1 COLUMN REMOVAL 1.....	D49
D5.3 STIFFNESS REQUIREMENTS.....	D52
D5.3.1 COLUMN REMOVAL 1.....	D52



## D1 INTRODUCTION

This design example is based on the baseline preliminary design utilized in Appendix D of UFC for a typical seven-story reinforced concrete frame facility located in a non-seismic region. For the purposes of this example, it is assumed that the building is GSA-owned, new construction and functions as a high occupancy office space for GSA tenants, which require a Facility Security Level (FSL) IV. The building has a controlled lobby and no below-grade parking. Based on the Applicability requirements of Chapter 2, the potential for progressive collapse must be considered and both the Alternate Path and Redundancy Requirements shall be applied.

This example was prepared using tools and techniques commonly applied by structural engineering firms in the U.S. To illustrate the various options given in these Guidelines, the example is prepared using the linear static and nonlinear dynamic analysis procedures.

## D2 BASELINE PRELIMINARY DESIGN

The baseline design presented in the UFC [31] is adopted for this example with minor modifications. The structure is a seven-story reinforced concrete structure with perimeter moment frames. The baseline design, shown in Figure D2.1 through Figure D2.5 was sized to meet the requirements of the International Building Code (IBC) 2006 [20]. In addition, the lateral drift of the frame was evaluated for a performance limit of  $L/400$  under a 10-year wind. Given its location in a non-seismic region, it is assumed that wind governs the design of the lateral system and the building does not need to meet the seismic provisions of ACI 318-11 Chapter 21 [3].

### D2.1 DESIGN AND MODELING ASSUMPTIONS

#### D2.1.1 CONNECTIONS

All connections between concrete elements can be considered moment connections if the reinforcement is continuous over the connection or is fully developed into the supporting structure. This example assumes that reinforcement is fully developed at all element connections.

#### D2.1.2 ELEMENTS

Pan Joists and Slab: The floor and roof system consists of a 5-in slab supported by reinforced concrete pan joists spanning between transverse beams. Both the floor and roof system were modeled as rigid diaphragms.

Concrete Framing: Reinforced concrete beams span between columns along the perimeter and at transverse gridlines. Members were represented by centerline elements.

#### D2.1.3 LOADING

The dead and live loads used in developing the baseline preliminary design are summarized in Table D12. The wind load ( $W$ ) was determined in accordance with IBC 2006 [20] using a 110-mph with exposure = B and an importance factor of 1.0. The earthquake load ( $E$ ) is not considered as the building is assumed



to be in a non-seismic region with wind governing the lateral design. Other loads, including snow (S) and rain (R) are also assumed to not control the design.

**Table D12: Gravity Loading**

	Roof	Floor
<b>Dead Load (D)</b>		
Self-Weight of Members	Variable	Variable
Slab and Pan Joists	89-psf	89-psf
Superimposed Dead Load	20-psf	10 psf
Cladding on Building Perimeter (CL)	60-psf (wall area)	60-psf (wall area)
<b>Live Load (LL)</b>		
Roof Live Load	20-psf	-
Floor Live Load (80-psf + 20-psf for Partitions)	-	70-psf

#### D2.1.4 MEMBER SIZES

Baseline preliminary member sizes resulting from design to meet the IBC 2006 [20] and loading identified in Section D2.1.3 are shown in Table D13 located as shown in Figure D2.1 through Figure D2.5. Floor design is identical for Levels 2 through 6 with reduced reinforcement provided at the roof level.

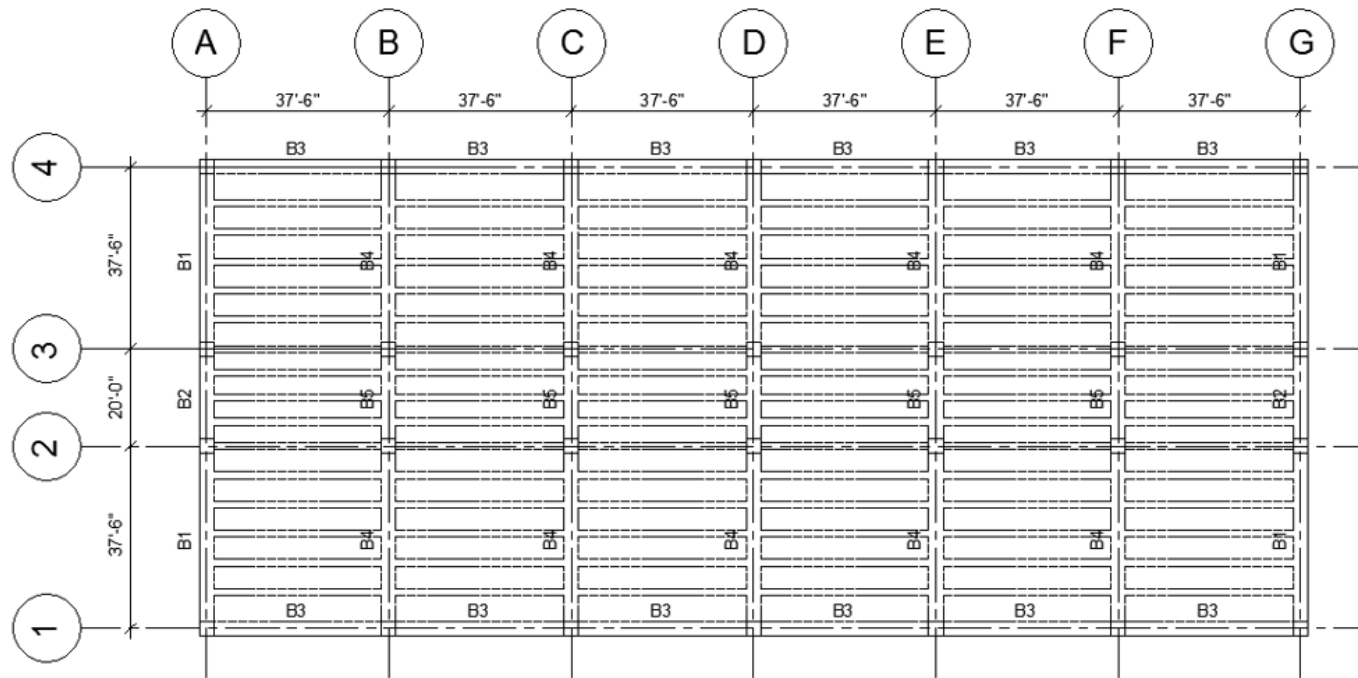
**Table D13: Preliminary Member Sizes**

Label	Element Type	Dimensions		Reinforcement		
		Width	Depth	Top	Bottom	Shear
B1	Floor Beam	36-in	25-in	(8)-#9	(9)-#9	(4) Legs of #4 @ 6" o.c.
B2	Floor Beam	36-in	25-in	(8)-#9	(6)-#8	(5) Legs of #4 @ 6" o.c.
B3	Floor Beam	36-in	25-in	(6)-#8	(6)-#7	(4) Legs of #4 @ 6" o.c.
B4	Floor Beam	36-in	25-in	(10)-#10	(12)-#10	(5) Legs of #4 @ 6" o.c.
B5	Floor Beam	36-in	25-in	(10)-#10	(7)-#9	(4) Legs of #4 @ 6" o.c.
RB1	Roof Beam	36-in	25-in	(7)-#9	(6)-#9	(4) Legs of #4 @ 6" o.c.
RB2	Roof Beam	36-in	25-in	(4)-#8	(6)-#9	(4) Legs of #4 @ 6" o.c.
RB3	Roof Beam	36-in	25-in	(5)-#7	(6)-#7	(4) Legs of #4 @ 6" o.c.
RB4	Roof Beam	36-in	25-in	(8)-#10	(9)-#9	(4) Legs of #4 @ 6" o.c.
RB5	Roof Beam	36-in	25-in	(6)-#8	(9)-#9	(4) Legs of #4 @ 6" o.c.





Label	Element Type	Dimensions		Reinforcement		
		Width	Depth	Top	Bottom	Shear
PJ1	Pan Joist	b = 72-in bw = 7.625-in	25-in	#3 @ 12" o.c.	(4)-#9	(1) Legs of #4 @ 6" o.c.
C1	Corner Column	36-in	36-in	(8)-#8		(3) Legs of #4 @ 6" o.c.
C2	Perimeter Column	36-in	36-in	(14)-#11		(3) Legs of #4 @ 6" o.c.
C3	Perimeter Column	36-in	36-in	(8)-#8		(3) Legs of #4 @ 6" o.c.
C4	Interior Column	36-in	36-in	(12)-#10		(3) Legs of #4 @ 6" o.c.



**Figure D2.1: Building Floor Plan (Levels 2-6)**

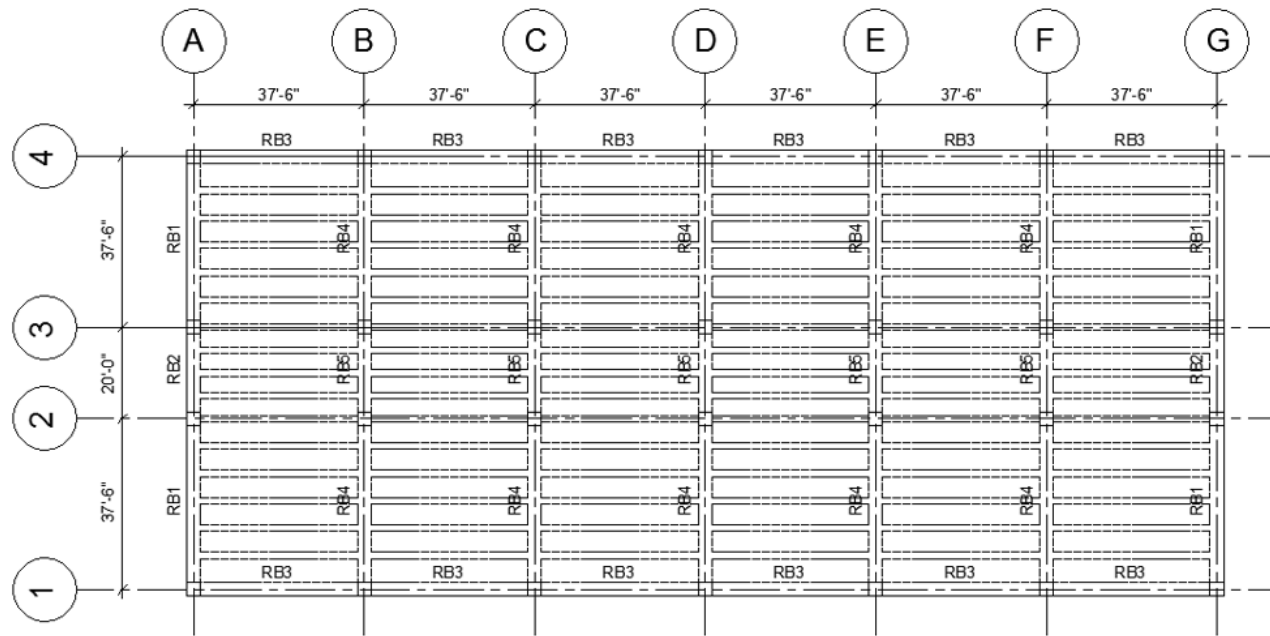


Figure D2.2: Building Roof Plan

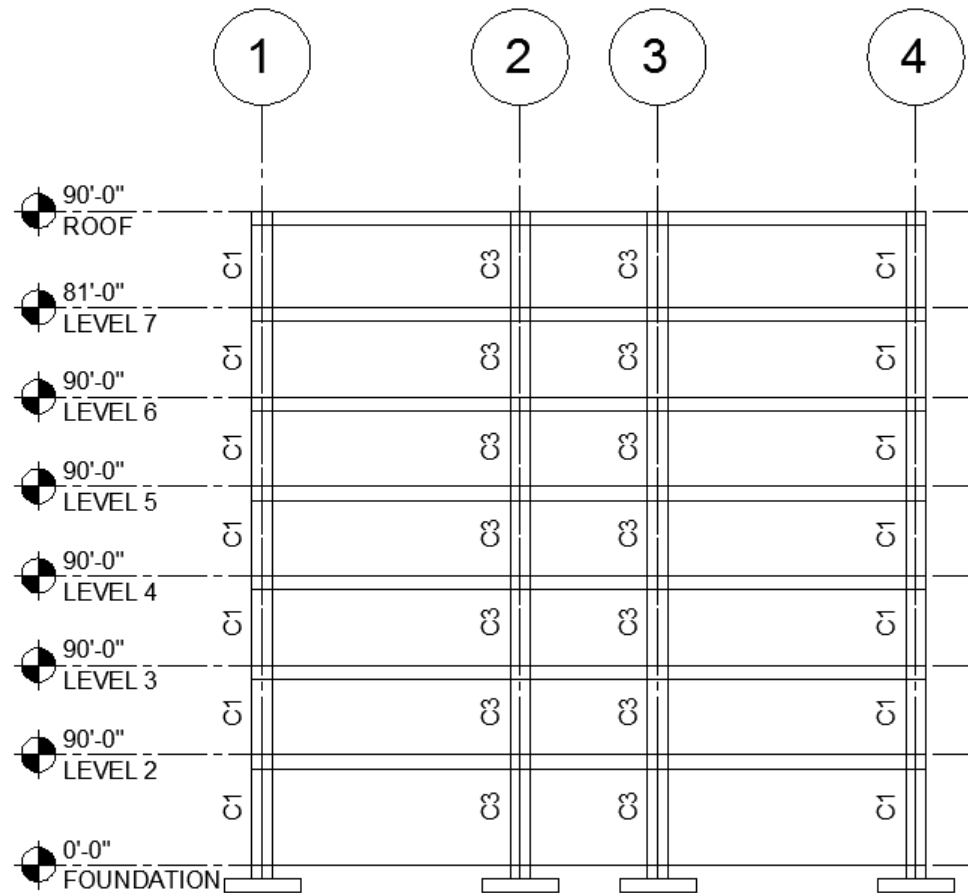


Figure D2.3: Building Elevation along GL A

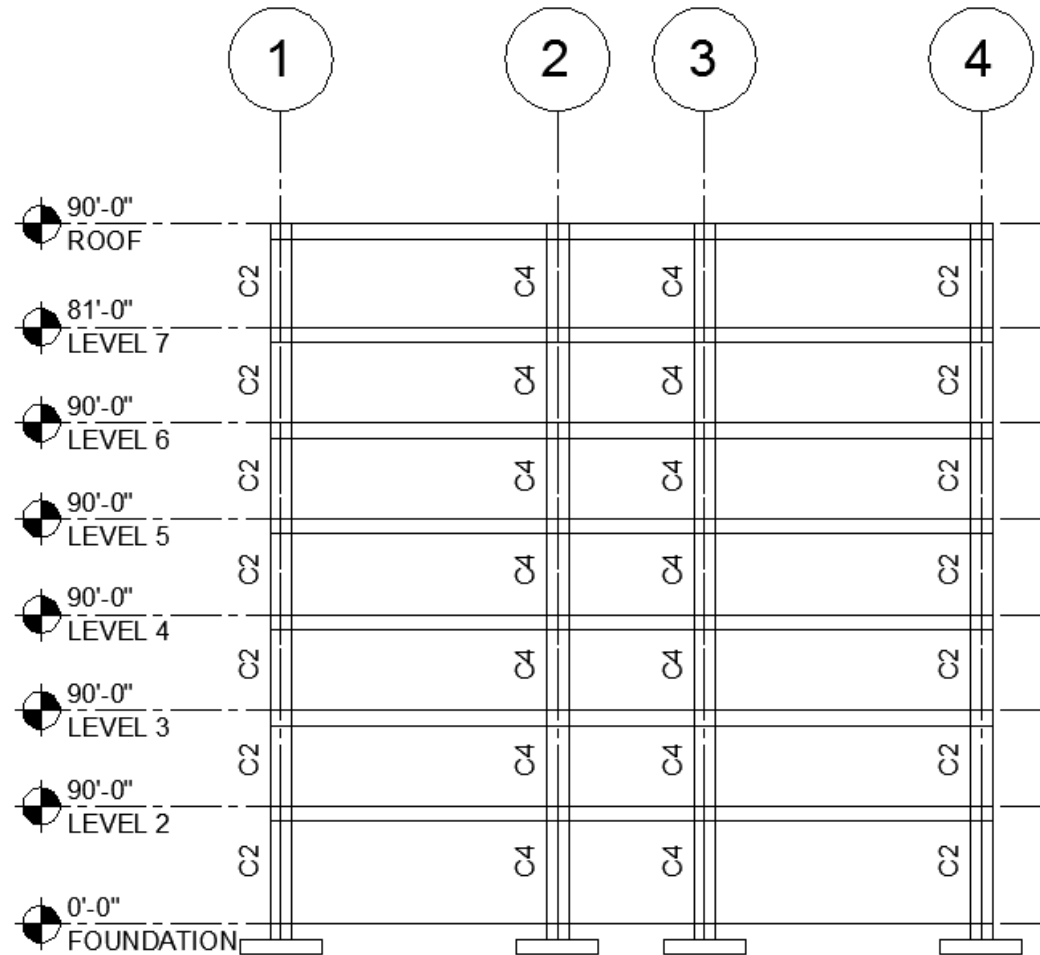
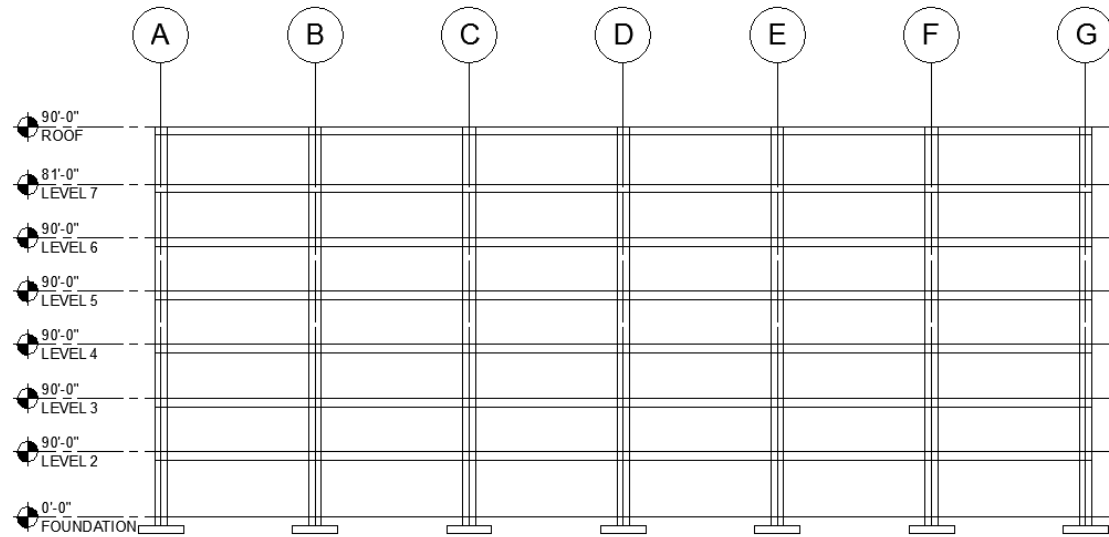


Figure D2.4: Building Elevation along B-F (Interior)



**Figure D2.5: Building Elevation along Gridline 1 and 4**

## D3 LINEAR STATIC PROCEDURE

This section provides a step-by-step guide to the application of the Linear Static Procedure (LSP) for the design example building.

### D3.1 DCR AND IRREGULARITY CHECK

The first step in performing a LSP analysis is determining whether the structure triggers any of the irregularity limitations of Section 3.2.11.1. If the structure is determined as irregular, the designer must then evaluate the DCR limits of Section 3.2.11.1.2 in order to determine whether the LSP can be used or if an alternative method (i.e. Nonlinear Static or Nonlinear Dynamic) is required.

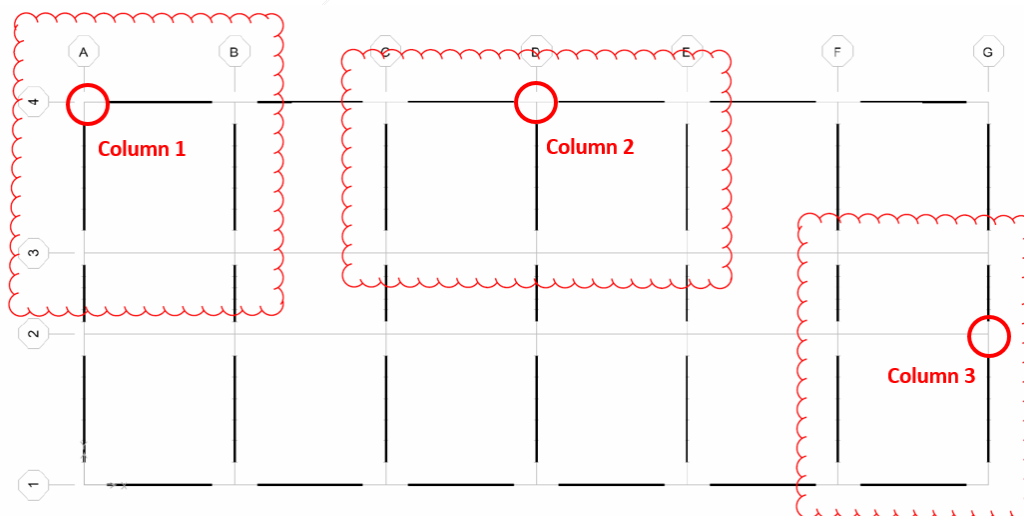
The baseline design does not trigger the irregularity limitations as: 1) it does not have any vertical discontinuities; 2) bay stiffness/strength does not vary in either direction at corner columns; and 3) all lateral-load resisting elements are parallel to the major orthogonal axes of the building. Therefore, the LSP can be used.

### D3.2 COLUMN REMOVAL LOCATIONS

Three representative column removal locations were considered in this analysis example, as shown in Figure D3.1:

- Removal 1 – Corner column condition.
- Removal 2 – Long side column condition.
- Removal 3 – Short side column condition.

In general, all components require evaluation for the acceptance criteria in these Guidelines; however for the purposes of this example, analysis results are only provided for the members in the bays adjacent to the column removal and at all floors above the column removal, as bubbled in red on Figure D3.1.



**Figure D3.1: Column Removal Locations**



### D3.3 ANALYTICAL MODELING

#### D3.3.1 PRIMARY AND SECONDARY ELEMENT CLASSIFICATION

Prior to developing the building model, elements need to be classified as either primary or secondary elements, in accordance with Section 3.2.4. Primary elements and their rotational stiffness/resistance are explicitly included in the model; however, the stiffness and resistance of those elements classified as secondary are not.

For the purposes of this example, all perimeter framing and interior transverse framing is considered primary. Floor/roof slabs and pan joists are classified as secondary. Elements classified as secondary are still required to be evaluated for the acceptance criteria of Section 3.2.10, however, using the less stringent criteria provided for secondary elements.

It should be noted that if the designer was to classify gravity framing as primary elements, connections could be modeled as partially restrained moment connections, and their rotational stiffness and resistance included. Once classified as primary, however, gravity framing would need to be evaluated to meet the more stringent acceptance criteria of Section 3.2.10 accordingly.

#### D3.3.2 CLASSIFICATION OF DEFORMATION AND FORCE-CONTROLLED ACTIONS

In order to develop the appropriate load combinations and acceptance criteria for the analysis all elements need to be classified as either deformation or force-controlled. Classification of deformation and force-controlled actions is performed in accordance with Section 3.2.5 and guidance provided in ASCE 41 [10]. A summary of the classification of deformation and force-controlled actions for each element is provided in Table D14. Evaluation of whether columns are deformation or force-controlled is a function of the shear load under the column removal scenario; therefore a check is required after completing the analysis.

**Table D14: Examples of Deformation-Controlled and Force-Controlled Actions from ASCE 41**

Component	Deformation-Controlled Action	Force- Controlled Action
Moment Frames <ul style="list-style-type: none"> <li>• Beams</li> <li>• Columns</li> <li>• Joints</li> </ul>	Moment (M) M, Axial Load (P) --	Shear (V) P, V V
Connections	M	V

For simplicity, the designer may consider developing two separate models due to different modeling requirements for loading and design strengths for deformation and force-controlled actions, as well as different acceptance criteria. A summary of the different modeling requirements for deformation and force-controlled actions is provided in Table D15. Additional discussion of these differences is provided in the applicable section below.

**Table D15: Model Requirements for Deformation and Force-Controlled Actions**

Design and/or Modeling Assumption	Deformation-Controlled	Force-Controlled
Design Strength	Expected ( $Q_{CE}$ )	Lower Bound ( $Q_{CL}$ )
Load Increase Factor	$1.2 m_{LIF} + 0.8$	2.0
Demand Modifier	m-factor	1.0



### D3.3.3 M-FACTORS

Each component within the structure is assigned an m-factor, or demand modifier. The demand-modifier can be considered as the allowable Demand-Capacity-Ratio and is evaluated as the force or deformation-controlled action divided by the design strength. The governing m-factor for each component is based on the smallest of the beam/girder elements.

An example calculation of m-factors for a typical beam, column, and beam column joint is provided below for Column Removal 1. Following the example, the m-factors for all the baseline design beams and columns (primary components) used in this example are listed in Table D16 and Table D17. It should be noted that all columns for the baseline design are force-controlled, as shown in Table D17; however for the purpose of the example calculation, columns were assumed to be deformation-controlled in order to demonstrate how to calculate the corresponding deformation-controlled m-factor.

For simplicity, only those elements that are considered critical for each column removal scenario are shown.

#### D3.3.3.1 TYPICAL BEAM COMPONENT

The m-factor for beam components is determined in accordance with Table 10-13 of ASCE 41 [10] based on a Collapse Prevention performance level and a Primary component classification. The m-factor is a function of the reinforcement ratio, transverse reinforcement, and shear demand. The following steps outline the general procedure for evaluating the appropriate m-factor:

- 1) Beam section properties for B1 are defined in the example as 36-in W x 25-in D with (8) #9 top Reinforcement, (9) #9 bottom reinforcement, and (5) legs of #4 shear reinforcement at 6-in on center:

$$\text{Beam Width, } b_w = 36 \text{ in}$$

$$\text{Beam Height, } h = 25 \text{ in}$$

$$\text{Depth to Btm. Reinf., } d = 22.5 \text{ in}$$

$$\text{Depth to Top Reinf., } d' = 2.5 \text{ in}$$

$$\text{Area of Btm. Steel, } A_s = 9 \text{ in}^2$$

$$\text{Area of Top Steel, } A'_s = 8 \text{ in}^2$$

$$\text{Shear Spacing, } s = 6 \text{ in}$$

$$\text{Area of Shear Reinf., } A_v = 1 \text{ in}^2$$

$$\text{Pos. Reinf. Ratio, } \rho = \frac{A_s}{b_w d} = 0.011$$

$$\text{Neg. Reinf. Ratio, } \rho' = \frac{A'_s}{b_w (d - d')} = 0.010$$

$$\text{Balanced Reinf. Ratio, } \rho_{bal} = 0.85 \beta_1 \frac{f'_c}{f_y} \frac{\epsilon_c}{\epsilon_c + \epsilon_s} = 0.034$$

- 2) Expected strength is defined based on deformation controlled action (i.e. flexure) for concrete and A615 steel using Tables 10-1 through 10-4 of ASCE 41 [10] :

$$\text{Steel Lower Bound Strength, } F_{yL} = 60 \text{ ksi}$$

(Table 10-3 – ASCE 41 [10])



Factor to translate to Expected Strength  
= 1.25

(Table 10-1 – ASCE 41 [10])

Expected strength,  $F_{ye} = F_{yl} \times 1.25 = 75\text{ksi}$

Concrete Compressive strength,  $f'_c = 5\text{ksi}$

- 3) The component/action is evaluated in accordance with the “Beams controlled by flexure” section of Table 7 of this document:

$$\frac{\rho - \rho'}{\rho_{bal}} = \frac{0.011 - 0.010}{0.034} = 0.037$$

$$\frac{d}{3} = \frac{22.5\text{in}}{3} = 7.5\text{in} \geq s$$

$$V_s = \frac{A_v f_{yl} d}{s} = 225\text{kips} > V$$

$$\frac{V}{b_w d \sqrt{f'_c}} = \frac{222\text{kips}}{36\text{in} (22.5\text{in}) \sqrt{5000\text{psi}}} = 3.88$$

- 4) The component/action is compared with limits a, b, and c :

$$a \quad \frac{\rho - \rho'}{\rho_{bal}} = 0.037 \quad 0.0 \leq \frac{\rho - \rho'}{\rho_{bal}} \leq 0.5$$

$$b \quad s = 6\text{in} \leq 7.5, \quad V = 222\text{kips} \leq V_s = \frac{A_v f_{yl} d}{s} \quad \text{Conforming, C}$$

$$c \quad \frac{V}{b_w d \sqrt{f'_c}} = 3.88 \quad 3.0 \leq \frac{V}{b_w d \sqrt{f'_c}} \leq 6.0$$

- 5) The governing m-factor is evaluated using linear extrapolation to determine the m-factor associated with a, linear interpolation to determine the m-factor associated with c, and then linear interpolation between a and c.

$$m_{a,3} = \frac{\frac{\rho - \rho'}{\rho_{bal}} - 0.0}{0.5 - 0.0} (m_{a,0.5,3} - m_{a,0.0,3}) + m_{a,0.0,3}$$

$$m_{a,3} = \frac{(0.037 - 0.0)}{(0.5 - .0)} (9 - 16) + 16 = 15.48$$

$$m_{a,6} = \frac{\frac{\rho - \rho'}{\rho_{bal}} - 0.0}{0.5 - 0.0} (m_{a,0.5,6} - m_{a,0.0,6}) + m_{a,0.0,6} = 8.88$$

$$m_{c,0.0} = \frac{\frac{V}{b_w d \sqrt{f'_c}} - 3}{6 - 3} (m_{c,0.0,6} - m_{a,0.0,3}) + m_{a,0.0,3} = 14.0$$



$$m_{c,0.5} = \frac{\frac{V}{b_w d \sqrt{f'_c}} - 3}{6 - 3} (m_{c,0.5,6} - m_{a,0.5,3}) + m_{a,0.5,3} = 8.12$$

$$m = \frac{\frac{V}{b_w d \sqrt{f'_c}} - 3}{6 - 3} (m_{a,6} - m_{a,3}) + m_{a,3} = 10.74$$

Interpolation yields an m-factor of 10.74

### D3.3.3.2 BEAM COLUMN JOINT

The m-factor for beam column joint is determined in accordance with of Table 10-14 ASCE 41 [10] based on a primary component classification and is a function of the column axial demand, beam and column transverse reinforcement, and joint shear. For primary components the m-factor listed in the table will always equal 1.0.

$$m = 1.0$$

### D3.3.3.3 COLUMN

The m-factor for column components is determined in accordance with Table 10-9 of ASCE 41 [10] based on a Collapse Prevention performance level and a Primary component classification. The m-factor is a function of the shear demand, axial demand, and reinforcement ratio of the column. The following steps outline the general procedure for evaluating the appropriate m-factor:

- 1) For preliminary evaluation of column m-factors it is assumed that the column is deformation-controlled and that the following equation is met:

$$\frac{V_p}{V_o} \leq 0.6$$

where  $V_p$  = Shear demand

$V_o$  = Shear capacity using expected material properties

This assumption needs to be verified after the column removal analysis is performed.

- 2) The column section properties C3 are defined in the example as 36-in W x 36-in D with a total of (8) #8 and (3) legs of #4 shear reinforcement at 6-in on center:

*Column Width,*  $b = 36in$

*Column Depth,*  $d = 36in$

*Total Area of Steel,*  $A_s = 6.32in^2$

*Total Column Area,*  $A_g = 1296in^2$

*Shear Area of Steel,*  $A_v = 0.6in^2$

*Shear Spacing,*  $s = 6in$

- 3) Define strength for concrete and A615 reinforcing steel using Tables 10-1 through 10-4 of ASCE 41 [10] :

*Steel Lower Bound Strength,*  
 $F_{y1} = 60ksi$

*(Table 10-3 – ASCE 41 [10])*

Factor to translate to Expected Strength (Table 10-1 – ASCE 41 [10])  
= 1.25

Expected strength,  $F_{ye} = F_{yl} \times 1.25 = 75\text{ksi}$

Concrete Compressive strength,  $f'_c = 5\text{ksi}$

- 4) Component/action is evaluated as deformation controlled in accordance Table 10-9 of ASCE 41 [10]:

$$\frac{P}{A_g f'_c} = \frac{2280\text{kips}}{1296\text{in}^2 (5\text{ksi})} = 0.35$$

$$\rho_v = \frac{A_v}{b_w s} = \frac{0.6\text{in}^2}{36\text{in} (6\text{in})} = 0.003$$

$$\frac{V}{b_w d \sqrt{f'_c}} = \frac{76\text{kips}}{36\text{in} (34\text{in}) \sqrt{5000\text{psi}}} = 0.88$$

- 5) Compare with limits a and b :

$$a \quad 0.1 \leq \frac{P}{A_g f'_c} \leq 0.6$$

$$b \quad 0.002 \leq \rho_v \leq 0.006$$

- 6) Determine governing m-factors for a primary element using Collapse Prevention. For preliminary evaluation of m-factors assumed that  $V_p/V_o \leq 0.6$ . The governing m-factor is evaluated using linear extrapolation to determine the m-factor associated with a, linear interpolation to determine the m-factor associated with b, and then linear interpolation between a and b. The final interpolation step is shown.

$$m = \frac{\rho_v - 0.002}{0.006 - 0.002} (m_{a,0.006} - m_{a,0.002}) + m_{a,0.002} = 2.0$$

Interpolation yields an m-factor of 2.0

**Table D16: Beam Component m-factors for Deformation Controlled Actions of Primary Components**

Column Removal	Beam Label	Beam Level	Governing m-factor
1	B1	2	10.74
	B1	3	10.89
	B1	4	10.78
	B1	5	10.78
	B1	6	10.74
	B1	7	10.85
	RB1	Roof	9.72
	B3	2	15.83



Column Removal	Beam Label	Beam Level	Governing m-factor
	B3	3	15.67
	B3	4	15.79
	B3	5	15.79
	B3	6	15.83
	B3	7	15.75
	RB3	Roof	16.00
	B4	2	8.77
	B4	3	14.69
	B4	4	14.69
	B4	5	14.69
	B4	6	14.69
	B4	7	14.69
	RB4	Roof	15.40
2	B3	1	15.71
	B3	2	15.71
	B3	3	15.79
	B3	4	15.83
	B3	5	15.87
	B3	6	15.79
	RB3	Roof	16.00
	B3	1	15.71
	B3	2	15.71
	B3	3	15.79
	B3	4	15.83
	B3	5	15.87
	B3	6	15.79
	RB3	Roof	16.00
	B4	1	14.69
	B4	2	14.69
	B4	3	14.69
	B4	4	14.69
	B4	5	14.69
	B4	6	14.69
	RB4	Roof	15.40
	B4	1	11.50
	B4	2	11.61
	B4	3	11.54
	B4	4	11.50
	B4	5	11.47
	B4	6	11.50
RB4	Roof	11.31	



Column Removal	Beam Label	Beam Level	Governing m-factor
	B4	1	14.69
	B4	2	14.69
	B4	3	14.69
	B4	4	14.69
	B4	5	14.69
	B4	6	14.69
	RB4	Roof	15.40
3	B2	1	13.06
	B2	2	12.73
	B2	3	13.18
	B2	4	13.39
	B2	5	13.59
	B2	6	13.55
	RB2	Roof	14.85
	B1	1	15.48
	B1	2	15.48
	B1	3	15.48
	B1	4	15.48
	B1	5	15.48
	B1	6	15.48
	RB1	Roof	15.48
	B3	1	16.00
	B3	2	16.00
	B3	3	16.00
	B3	4	16.00
	B3	5	16.00
	B3	6	16.00
	RB3	Roof	16.00
	B4	1	14.69
	B4	2	14.69
	B4	3	14.69
	B4	4	14.69
	B4	5	14.69
	B4	6	14.69
	RB4	Roof	15.40
	B5	1	16.00
	B5	2	16.00
	B5	3	16.00
	B5	4	16.00
B5	5	16.00	
B5	6	16.00	
RB5	Roof	16.00	



**Table D17: Column Component m-factors for Deformation & Force Controlled Actions of Primary Components**

Column Removal	Column Label	Column Level	Vp/Vo	Governing m-factor
1	C3	1	3.31	Force-Controlled
	C3	2	4.12	Force-Controlled
	C3	3	3.85	Force-Controlled
	C3	4	3.51	Force-Controlled
	C3	5	3.04	Force-Controlled
	C3	6	2.47	Force-Controlled
	C3	7	1.67	Force-Controlled
	C4	1	4.07	Force-Controlled
	C4	2	5.04	Force-Controlled
	C4	3	4.78	Force-Controlled
	C4	4	4.45	Force-Controlled
	C4	5	4.07	Force-Controlled
	C4	6	3.67	Force-Controlled
	C4	7	2.92	Force-Controlled
	C2	1	4.47	Force-Controlled
	C2	2	6.01	Force-Controlled
	C2	3	5.99	Force-Controlled
	C2	4	5.76	Force-Controlled
	C2	5	5.39	Force-Controlled
	C2	6	4.94	Force-Controlled
	C2	7	3.96	Force-Controlled
	-	1	-	-
	C1	2	1.19	Force-Controlled
	C1	3	1.19	Force-Controlled
	C1	4	1.17	Force-Controlled
	C1	5	1.17	Force-Controlled
	C1	6	1.20	Force-Controlled
	C1	7	1.14	Force-Controlled
2	C2	1	4.47	Force-Controlled
	C2	2	6.01	Force-Controlled
	C2	3	5.92	Force-Controlled
	C2	4	5.76	Force-Controlled
	C2	5	5.39	Force-Controlled
	C2	6	4.94	Force-Controlled
	C2	7	3.97	Force-Controlled
	C4	1	4.07	Force-Controlled



Column Removal	Column Label	Column Level	Vp/Vo	Governing m-factor
	C4	2	5.04	Force-Controlled
	C4	3	4.78	Force-Controlled
	C4	4	4.45	Force-Controlled
	C4	5	4.07	Force-Controlled
	C4	6	3.67	Force-Controlled
	C4	7	2.92	Force-Controlled
	C4	1	4.17	Force-Controlled
	C4	2	5.12	Force-Controlled
	C4	3	4.99	Force-Controlled
	C4	4	4.78	Force-Controlled
	C4	5	4.39	Force-Controlled
	C4	6	3.91	Force-Controlled
	C4	7	3.10	Force-Controlled
	C4	1	4.07	Force-Controlled
	C4	2	5.04	Force-Controlled
	C4	3	4.78	Force-Controlled
	C4	4	4.45	Force-Controlled
	C4	5	4.07	Force-Controlled
	C4	6	3.67	Force-Controlled
	C4	7	2.92	Force-Controlled
	C2	1	4.47	Force-Controlled
	C2	2	6.01	Force-Controlled
	C2	3	5.92	Force-Controlled
	C2	4	5.76	Force-Controlled
	C2	5	5.39	Force-Controlled
	C2	6	4.94	Force-Controlled
	C2	7	3.97	Force-Controlled
	-	1	-	-
	C2	2	3.68	Force-Controlled
	C2	3	3.68	Force-Controlled
	C2	4	3.67	Force-Controlled
	C2	5	3.66	Force-Controlled
C2	6	3.68	Force-Controlled	
C2	7	3.44	Force-Controlled	
3	C3	1	3.33	Force-Controlled
	C3	2	4.35	Force-Controlled
	C3	3	4.11	Force-Controlled





Column Removal	Column Label	Column Level	Vp/Vo	Governing m-factor
	C3	4	3.77	Force-Controlled
	C3	5	3.31	Force-Controlled
	C3	6	2.67	Force-Controlled
	C3	7	1.76	Force-Controlled
	C4	1	4.07	Force-Controlled
	C4	2	5.04	Force-Controlled
	C4	3	4.77	Force-Controlled
	C4	4	4.44	Force-Controlled
	C4	5	4.07	Force-Controlled
	C4	6	3.67	Force-Controlled
	C4	7	2.91	Force-Controlled
	C4	1	4.07	Force-Controlled
	C4	2	5.04	Force-Controlled
	C4	3	4.77	Force-Controlled
	C4	4	4.44	Force-Controlled
	C4	5	4.07	Force-Controlled
	C4	6	3.67	Force-Controlled
	C4	7	2.91	Force-Controlled
	C2	1	4.65	Force-Controlled
	C2	2	5.86	Force-Controlled
	C2	3	5.69	Force-Controlled
	C2	4	5.40	Force-Controlled
	C2	5	5.08	Force-Controlled
	C2	6	4.63	Force-Controlled
	C2	7	3.81	Force-Controlled
	C1	1	3.11	Force-Controlled
	C1	2	3.77	Force-Controlled
	C1	3	3.50	Force-Controlled
	C1	4	3.12	Force-Controlled
	C1	5	2.69	Force-Controlled
	C1	6	2.19	Force-Controlled
	C1	7	1.52	Force-Controlled
	-	1	-	-
	C3	2	1.22	Force-Controlled
	C3	3	1.24	Force-Controlled
	C3	4	1.23	Force-Controlled
	C3	5	1.21	Force-Controlled



Column Removal	Column Label	Column Level	Vp/Vo	Governing m-factor
	C3	6	1.18	Force-Controlled
	C3	7	1.11	Force-Controlled

### D3.3.4 LOAD INCREASE FACTORS

Section 3.2.11.5 provides load increase factors (Table 4) for areas of framing immediately surrounding the column removal. For steel frame structures, the load increase factor for forced-controlled actions is 2.0. For deformation-controlled actions the load increase factor is a function of the smallest m-factor of any primary beam or girder that is directly above the removal location. The load increase factors for this example are shown in Table D18 for each column removal.

**Table D18: Load Increase Factors ( $\Omega$ )**

Column Removal	Deformation-Controlled		Force-Controlled
	$m_{LIF}$ (smallest m-factor)	$\Omega_{LD} = 1.1 m_{LIF} + 0.8$	$\Omega_{LF}$
1	9.7	12.5	2
2	11.3	14.4	2
3	12.7	16.1	2

### D3.3.5 LOAD COMBINATIONS

Section 3.2.11.4 provides the required load combinations for use in a LSP. Three different load combinations are provided for use in the analysis, depending on whether deformation or force-controlled actions are used and the location of the elements being loaded as it relates to the column being removed.

For those bays immediately adjacent to the removed element and at all floors above the removed element the load combination includes a load increase factor, discussed in Section D3.3.4. For deformation-controlled actions:

$$G_{LD} = \Omega_{LD} [1.2 D + (0.5 L \text{ or } 0.2 S)] \quad \text{Equation 3.10}$$

where  $G_{LD}$  = Increased gravity loads for deformation-controlled actions for Linear Static analysis

$D$  = Dead load including façade loads ( $\text{lb/ft}^2$  or  $\text{kN/m}^2$ )

$L$  = Live load including live load reduction not to exceed  $50\text{-lb/ft}^2$  or  $244\text{-kN/m}^2$

$S$  = Snow load ( $\text{lb/ft}^2$  or  $\text{kN/m}^2$ )

$\Omega_{LD}$  = Load increase factor for calculating deformation- controlled actions



For force-controlled actions:

$$G_{LF} = \Omega_{LF} [1.2 D + (0.5 L \text{ or } 0.2 S)] \quad \text{Equation 3.10}$$

where  $G_{LF}$  = Increased gravity loads for force-controlled actions for Linear Static analysis

For those bays not immediately adjacent to the removed element the load combination is the same for both deformation and force-controlled actions:

$$G = 1.2 D + (0.5 L \text{ or } 0.2 S) \quad \text{Equation 3.10}$$

where  $G$  = Gravity loads

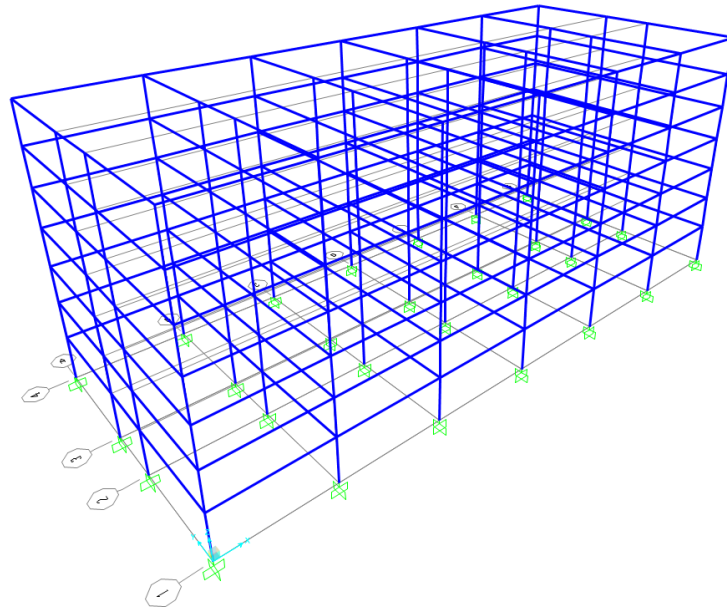
It should be noted that all load combinations include a limit of 50-lb/ft<sup>2</sup> or 244-kN/m<sup>2</sup> for the unfactored live loads used in the analysis. For this example, this would result in a 28% reduction of the baseline design live load of 70-psf.

## D4 ALTERNATIVE PATH ANALYSIS

This section presents the analysis steps performed as part of the Linear Static Procedure and the design requirements and modeling assumptions described in the previous sections. The software used and screenshots depicted are from SAP2000 V.15.2.1. For the purpose of this example, redistribution of loads upon column removal was performed manually; however, the designer may also use features such as SAP's "Staged Construction" to ensure proper redistribution.

### D4.1 DEVELOP PRELIMINARY MODEL

The model developed in SAP2000 is shown in Figure D4.1. As discussed in Section D3.3.1, the model perimeter framing and interior transverse framing only. One model was used to evaluate deformation and force-controlled actions using multiple load cases.



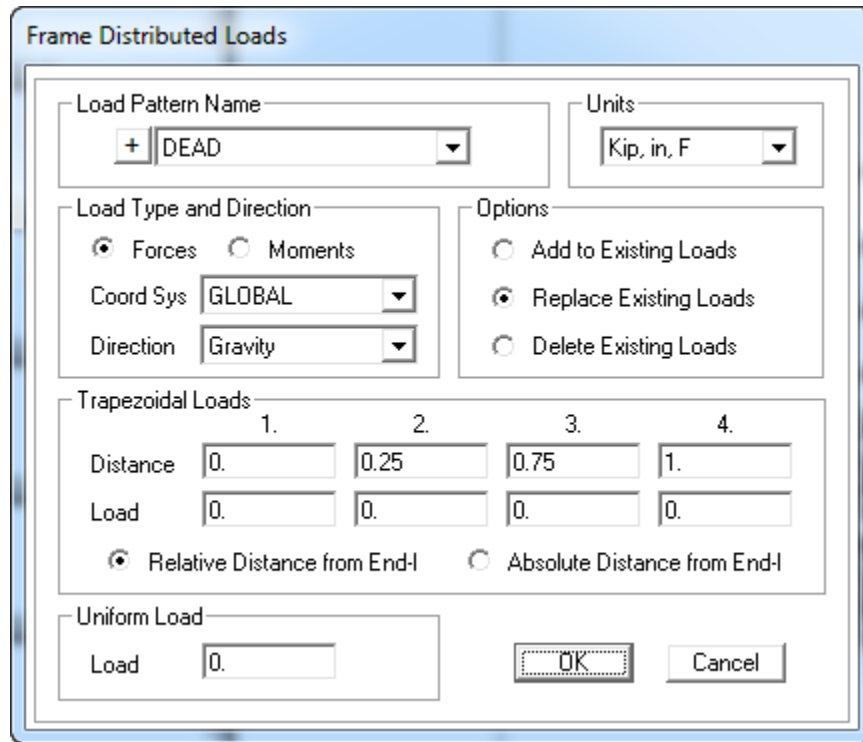
**Figure D4.1: Isometric View of SAP Model**

## D4.2 DEFINE LOAD CASES AND ASSIGN LOADS.

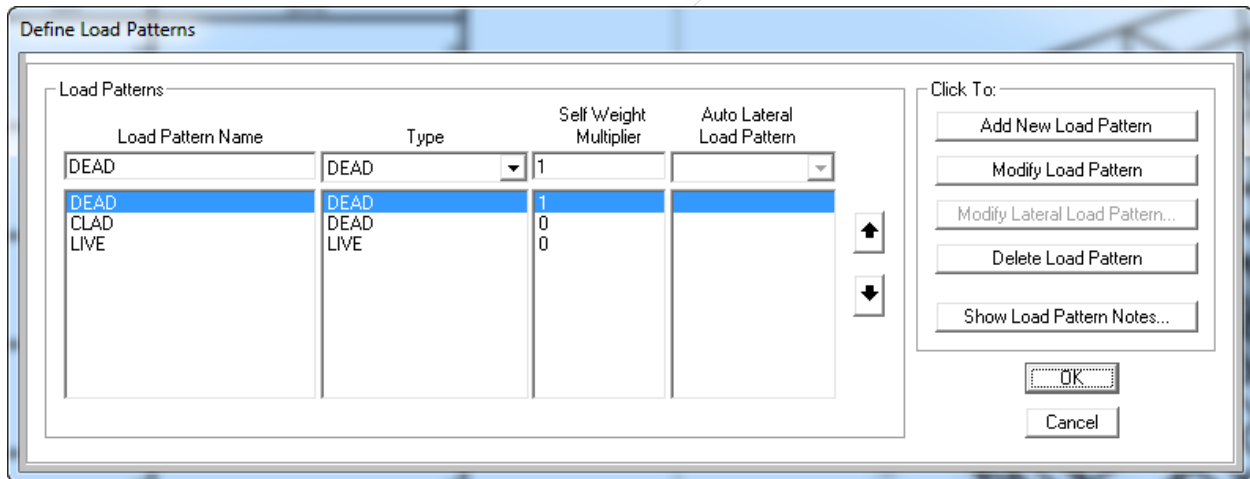
The applied load on each member is defined as a distributed line load based on the appropriate tributary width and load increase factor using load patterns, as shown in Figure D4.2. Three load patterns were used in this example for each column removal and action: DEAD (dead), CLAD (cladding), and LIVE (live load).

Load patterns can be adjusted to include a self-weight multiplier, which when set to 1.0 includes the self-weight of the member in the specified load pattern. For this example, a self-weight multiplier is applied to the DEAD (dead load) load pattern as shown in the screenshot in Figure D4.3. A self-weight modifier should only be applied to one load pattern so that it is only included in the analysis once.

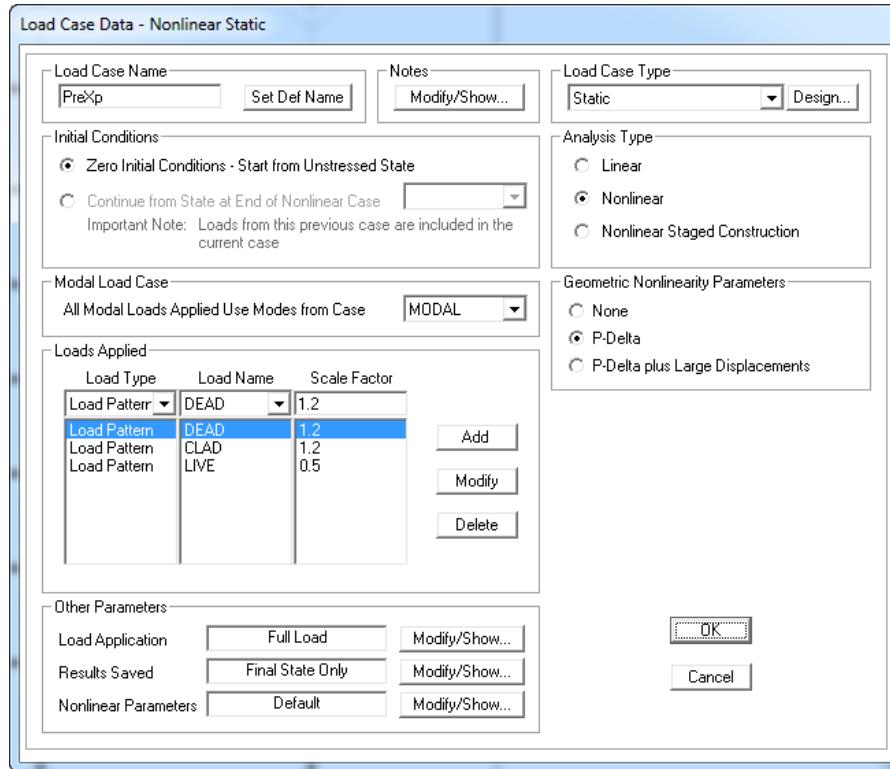
Load patterns are combined using the load combinations described in Section D3.3.5. SAP2000 uses load cases to combine the load patterns in terms of scale factors as shown in Figure D4.4. When assigning load cases, the designer must also define the type of analysis to be performed. While this is a linear static procedure, the nonlinear analysis check-box is selected to allow to evaluation of P-Delta effects, which is a non-linear behavior.



**Figure D4.2: Screenshot from SAP2000 for Load Pattern Assignment**



**Figure D4.3: Summary of Load Pattern Assignments**



**Figure D4.4: Load Case Input in SAP**

### D4.3 RUN ANALYSIS AND COMPARE TO ACCEPTANCE CRITERIA

It is important to check that both stages (before and after column removal) of every analysis case converge. If the analysis does not converge there is a problem with the model that must be fixed prior to proceeding with the analysis.

After each analysis case converges, the demand-capacity-ratio (DCR) of each component is evaluated ( $Q_{UD}/\Phi Q_{CE}$  or  $Q_{UF}/\Phi Q_{CL}$ ) and compared to the defined acceptance criteria. The demand used to calculate the DCR at beam column joints shall be based on the shear capacity required for beams spanning into the joint to reach their maximum moment capacity. For deformation-controlled elements, the DCR is compared to the governing m-factor for the element and its connections. For force-controlled elements the DCR must be less than 1.0.

To verify the assumption of deformation-controlled actions for columns, the deformation-controlled model is reviewed to determine the shear load ratio ( $V_p/V_o$ ) for each removal scenario. In accordance with ASCE 41 [10], any column with a shear load ratio greater than or equal to 0.6 must be reclassified as force-controlled and reevaluated under the force-controlled modeling assumptions.

Analysis results for the performance of the baseline design under each column removal are shown in Figure D4.5 through Figure D4.14. Resulting DCR's of each element are shown directly below the section size. Values in red indicate that the acceptance criterion is not met for that particular section and upgrade is required. Values in blue indicate that the acceptance criterion is met by the current member size.

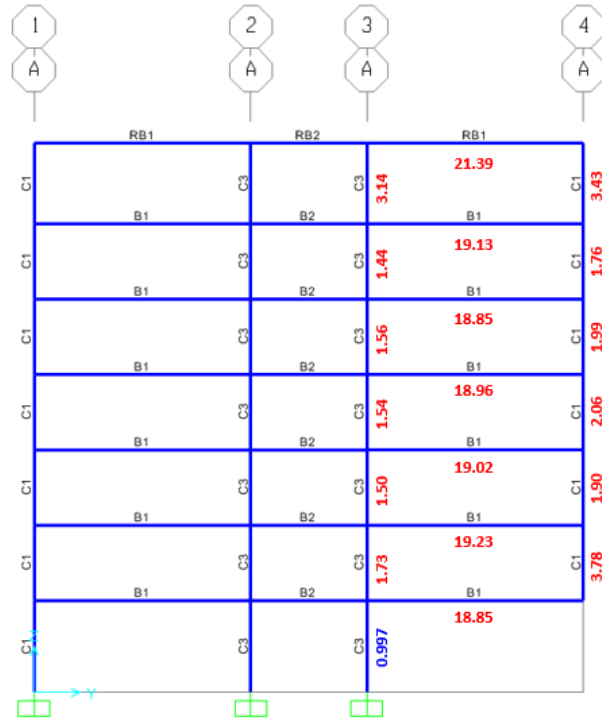


Figure D4.5: Column Removal 1 Original Design along Gridline A

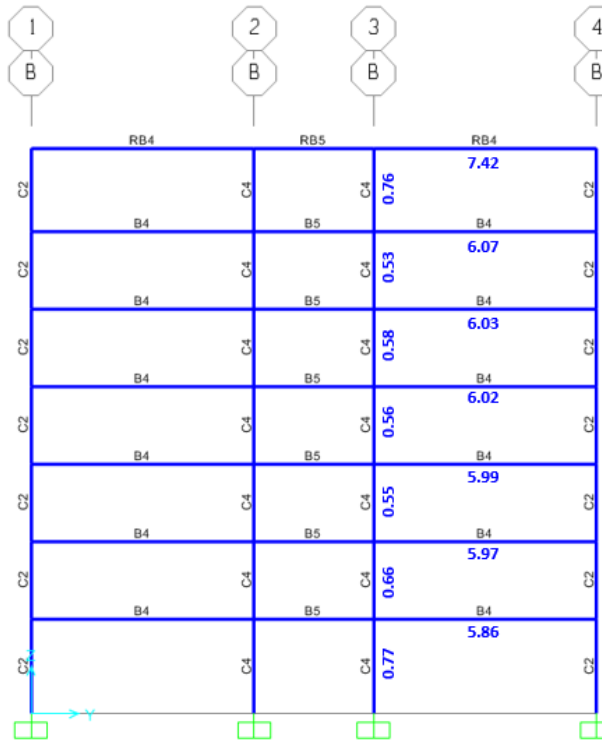


Figure D4.6: Column Removal 1 Original Design along Gridline B

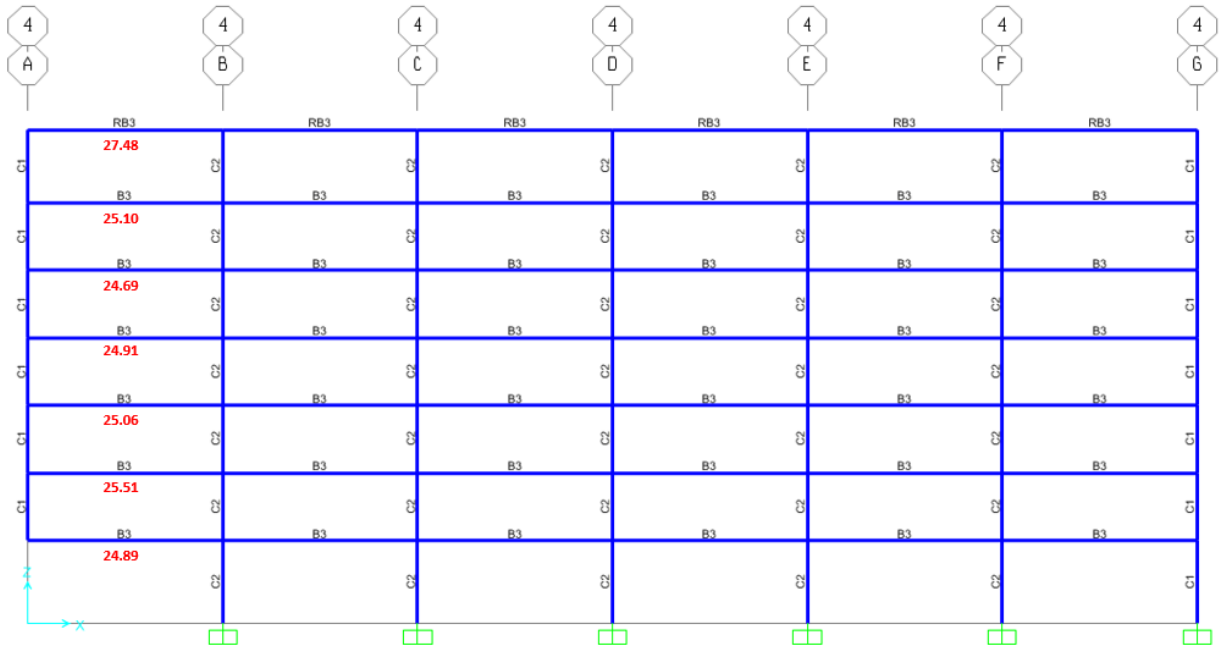


Figure D4.7: Column Removal 1 Original Design along Gridline 4

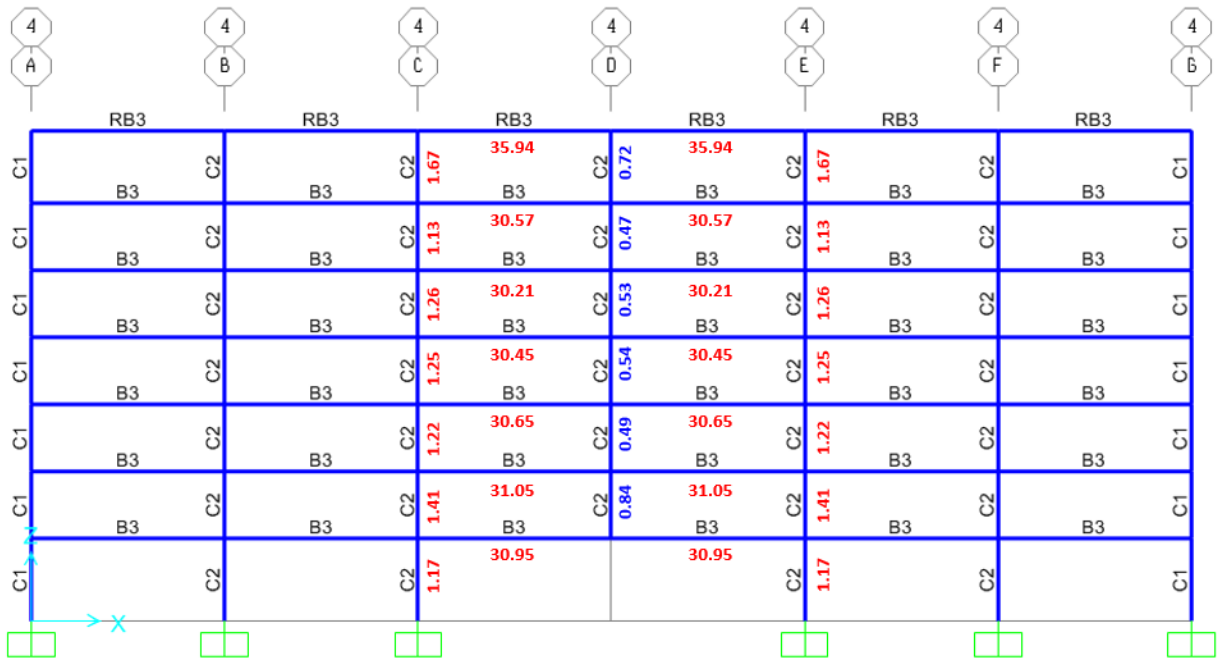


Figure D4.8: Column Removal 2 Original Design along Gridline 4



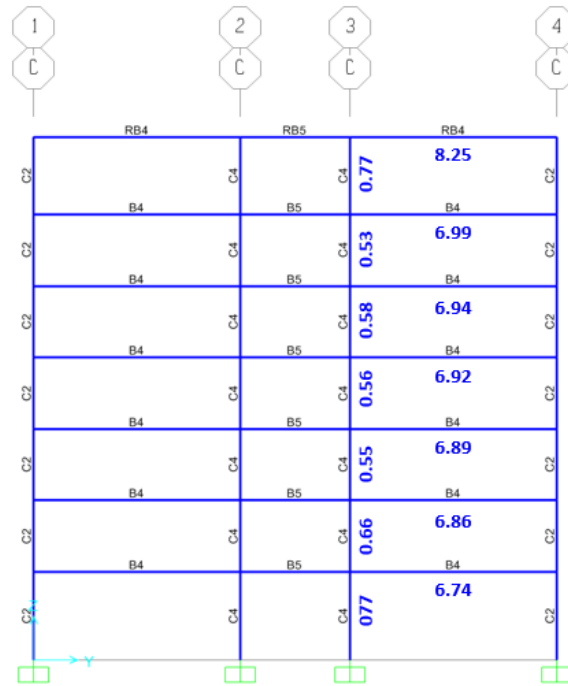


Figure D4.9: Column Removal 2 Original Design along Gridline C

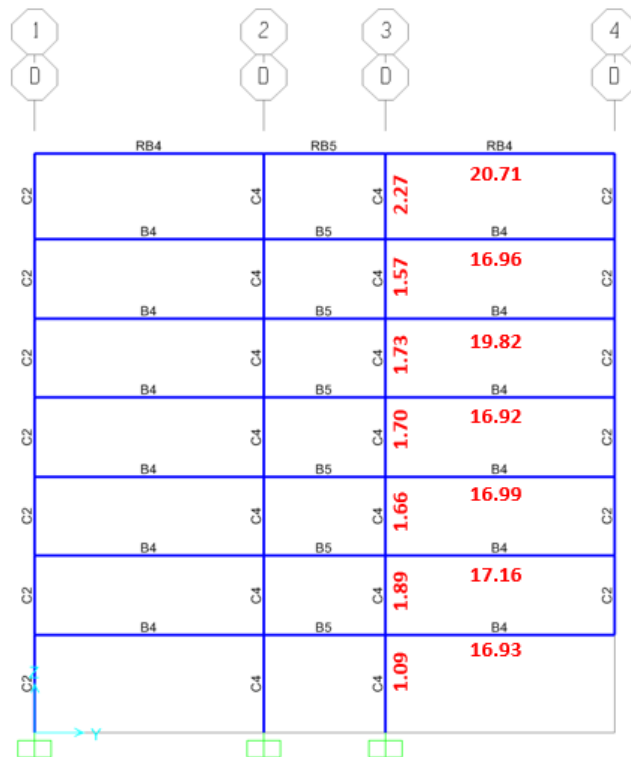


Figure D4.10: Column Removal 2 Original Design along Gridline D

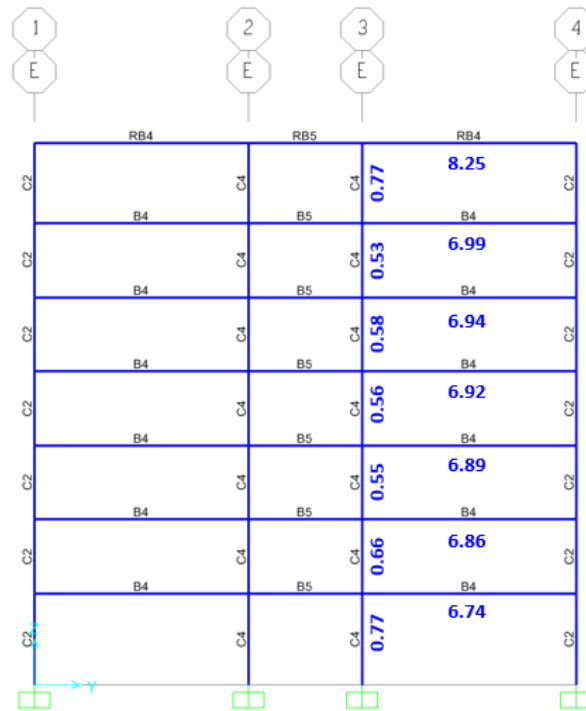


Figure D4.11: Column Removal 2 Original Design along Gridline E

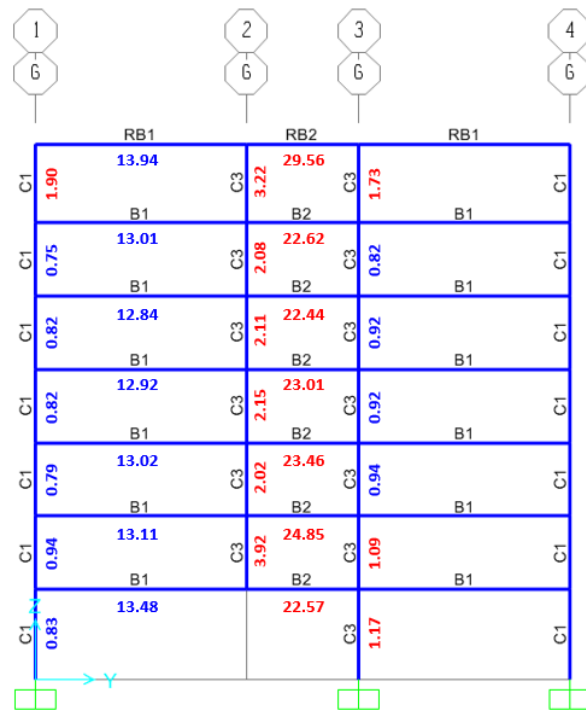


Figure D4.12: Column Removal 3 Original Design along Gridline G

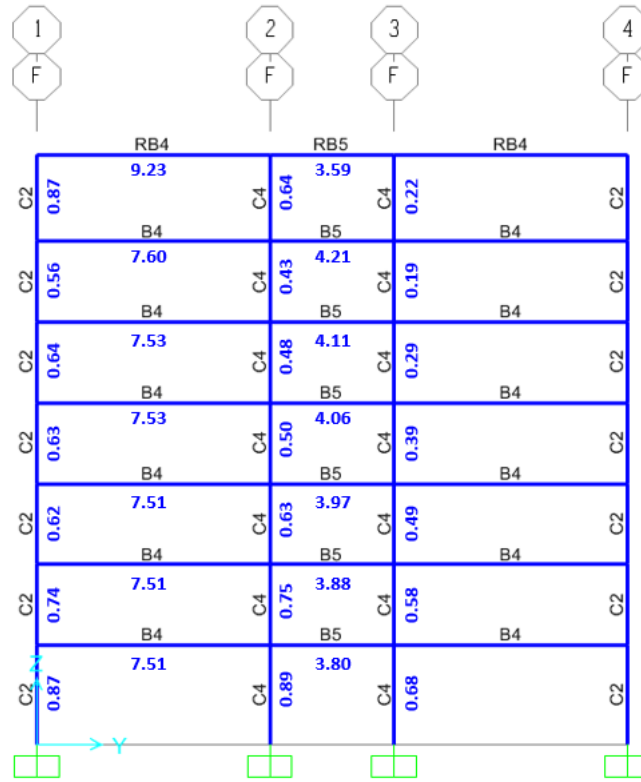


Figure D4.13: Column Removal 3 Original Design along Gridline F

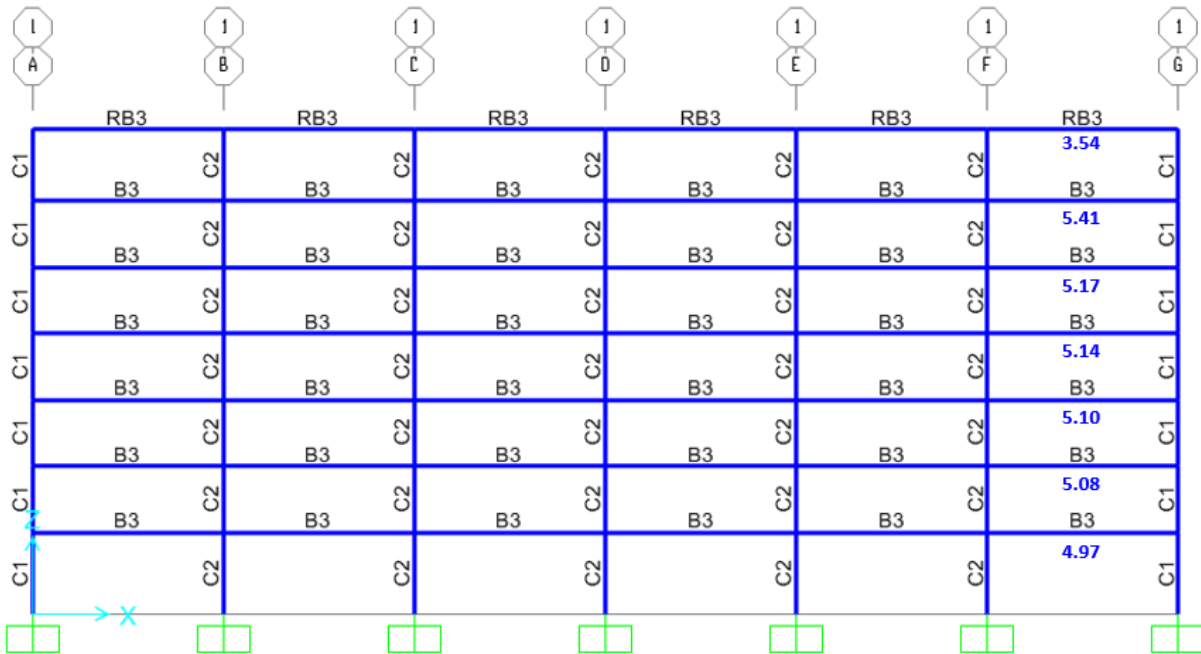


Figure D4.14: Column Removal 3 Original Design along Gridline 1



As shown in the previous figures, elements surrounding all column removal cases require redesign to meet the acceptance criteria.

As the members are redesigned, the m-factors must be adjusted accordingly for the redesigned members. The redesigned element section sizes and reinforcement are listed in Table D19. The adjusted m-factors for the redesigned members are shown in Table D20 and Table D21. The analysis results for the redesigned members are shown in Figure D4.15 through Figure D4.20.

**Table D19: Upgraded Sections**

Label	Element Type	Dimensions		Reinforcement		
		Width	Depth	Top	Bottom	Shear
B1-U1	Upgraded Floor Beam	36-in	25-in	(12)-#9	(9)-#9	(4) Legs of #4 @ 6" o.c.
B2-U1	Upgraded Floor Beam	36-in	25-in	(10)-#10	(9)-#9	(5) Legs of #4 @ 6" o.c.
B2-U2	Upgraded Floor Beam	36-in	25-in	(10)-#10	(10)-#9	(5) Legs of #4 @ 6" o.c.
B3-U1	Upgraded Floor Beam	36-in	25-in	(8)-#9	(8)-#8	(4) Legs of #4 @ 6" o.c.
B3-U2	Upgraded Floor Beam	36-in	25-in	(10)-#9	(9)-#8	(4) Legs of #4 @ 6" o.c.
B4-U1	Upgraded Floor Beam	36-in	25-in	(16)-#10 (2 rows of 8)	(12)-#10	(5) Legs of #4 @ 6" o.c.
RB1-U1	Upgraded Roof Beam	36-in	25-in	(9)-#9	(7)-#9	(4) Legs of #4 @ 6" o.c.
RB2-U1	Upgraded Roof Beam	36-in	25-in	(9)-#9	(9)-#8	(4) Legs of #4 @ 6" o.c.
RB3-U1	Upgraded Roof Beam	36-in	25-in	(8)-#8	(8)-#8	(4) Legs of #4 @ 6" o.c.
RB3-U2	Upgraded Roof Beam	36-in	25-in	(9)-#9	(9)-#8	(4) Legs of #4 @ 6" o.c.
RB4-U1	Upgraded Roof Beam	36-in	25-in	(12)-#10	(8)-#10	(4) Legs of #4 @ 6" o.c.
C1-U1	Upgraded Corner Column	36-in	36-in	(24)-#11		(5) Legs of #4 @ 6" o.c.
C1-U2	Upgraded Corner Column	36-in	36-in	(12)-#10		(3) Legs of #4 @ 6" o.c.
C1-U3	Upgraded Corner Column	36-in	36-in	(24)-#11		(4) Legs of #4 @ 6" o.c.
C1-U4	Upgraded Corner Column	36-in	36-in	(14)-#11		(4) Legs of #4 @ 6" o.c.
C2-U1	Upgraded Perimeter Column	36-in	36-in	(14)-#11		(4) Legs of #4 @ 4" o.c.



Label	Element Type	Dimensions		Reinforcement		
		Width	Depth	Top	Bottom	Shear
C2-U2	Upgraded Perimeter Column	36-in	36-in	(14)-#11		(4) Legs of #4 @ 6" o.c.
C2-U3	Upgraded Perimeter Column	36-in	36-in	(24)-#11		(4) Legs of #4 @ 4" o.c.
C2-U4	Upgraded Perimeter Column	36-in	36-in	(26)-#11		(6) Legs of #4 @ 6" o.c.
C2-U5	Upgraded Perimeter Column	36-in	36-in	(26)-#11		(3) Legs of #4 @ 6" o.c.
C2-U6	Upgraded Perimeter Column	36-in	36-in	(18)-#11		(4) Legs of #4 @ 4" o.c.
C3-U1	Upgraded Perimeter Column	36-in	36-in	(12)-#10		(4) Legs of #4 @ 4" o.c.
C3-U2	Upgraded Perimeter Column	36-in	36-in	(24)-#11		(5) Legs of #4 @ 4" o.c.
C3-U3	Upgraded Perimeter Column	36-in	36-in	(8)-#8		(3) Legs of #4 @ 3.5" o.c.
C3-U4	Upgraded Perimeter Column	36-in	36-in	(14)-#11		(3) Legs of #4 @ 6" o.c.
C3-U5	Upgraded Perimeter Column	36-in	36-in	(8)-#8		(3) Legs of #4 @ 4" o.c.
C3-U6	Upgraded Perimeter Column	36-in	36-in	(14)-#11		(4) Legs of #4 @ 6" o.c.
C3-U7	Upgraded Perimeter Column	36-in	36-in	(12)-#10		(4) Legs of #4 @ 6" o.c.
C3-U8	Upgraded Perimeter Column	36-in	36-in	(16)-#11		(4) Legs of #4 @ 6" o.c.
C4-U1	Upgraded Interior Column	36-in	36-in	(18)-#11		(3) Legs of #4 @ 6" o.c.
C4-U2	Upgraded Interior Column	36-in	36-in	(12)-#10		(4) Legs of #4 @ 4" o.c.
C4-U3	Upgraded Interior Column	36-in	36-in	(28)-#11		(5) Legs of #4 @ 4" o.c.



**Table D20: Upgraded beam m-factors**

Column Removal	Beam Label	Beam Level	Governing m-factor	DCR
1	B1-U1	2	13.96	12.97
	B1-U1	3	13.79	13.23
	B1-U1	4	13.92	13.08
	B1-U1	5	13.92	13.04
	B1-U1	6	13.96	12.97
	B1-U1	7	13.83	13.16
	RB1-U1	Roof	15.02	14.59
	B3-U1	2	15.83	15.12
	B3-U1	3	15.67	15.49
	B3-U1	4	15.79	15.22
	B3-U1	5	15.79	15.13
	B3-U1	6	15.83	14.99
	B3-U1	7	15.75	15.25
	RB3-U1	Roof	16.00	15.98
	B4	2	8.77	5.86
	B4	3	14.69	5.97
	B4	4	14.69	5.99
	B4	5	14.69	6.02
	B4	6	14.69	6.03
	B4	7	14.69	6.07
RB4	Roof	15.40	7.42	
2	B3-U2	1	15.71	15.33
	B3-U2	2	15.71	15.32
	B3-U2	3	15.79	15.13
	B3-U2	4	15.83	15.03
	B3-U2	5	15.87	14.91
	B3-U2	6	15.79	15.09
	RB3-U2	Roof	16.00	15.64
	B3-U2	1	15.71	15.33
	B3-U2	2	15.71	15.32
	B3-U2	3	15.79	15.13
	B3-U2	4	15.83	15.03
	B3-U2	5	15.87	14.91
	B3-U2	6	15.79	15.09
	RB3-U2	Roof	16.00	15.64
	B4	1	14.60	7.27



Column Removal	Beam Label	Beam Level	Governing m-factor	DCR
	B4	2	14.60	7.40
	B4	3	14.60	7.43
	B4	4	14.60	7.47
	B4	5	14.60	7.49
	B4	6	14.60	7.54
	RB4	Roof	15.40	8.25
	B4-U1	1	12.57	12.23
	B4-U1	2	12.45	12.39
	B4-U1	3	12.53	12.26
	B4-U1	4	12.57	12.22
	B4-U1	5	12.61	12.15
	B4-U1	6	12.57	12.24
	RB4-U1	Roof	13.30	12.86
	B4	1	14.69	6.74
	B4	2	14.69	6.86
	B4	3	14.69	6.89
	B4	4	14.69	6.92
	B4	5	14.69	6.94
	B4	6	14.69	6.99
	RB4	Roof	15.40	8.25
3	B2-U1	1	13.06	12.28
	B2-U2	2	12.73	12.64
	B2-U1	3	13.18	12.77
	B2-U1	4	13.39	12.52
	B2-U1	5	13.59	12.21
	B2-U1	6	13.55	12.31
	RB2-U1	Roof	14.85	13.69
	B1	1	15.48	13.48
	B1	2	15.48	13.11
	B1	3	15.48	13.02
	B1	4	15.48	12.92
	B1	5	15.48	12.84
	B1	6	15.48	13.01
	RB1	Roof	15.48	13.94
	B3	1	16.00	4.97
	B3	2	16.00	5.08
	B3	3	16.00	5.10
	B3	4	16.00	5.14



Column Removal	Beam Label	Beam Level	Governing m-factor	DCR
	B3	5	16.00	5.17
	B3	6	16.00	5.41
	RB3	Roof	16.00	3.54
	B4	1	14.69	7.51
	B4	2	14.69	7.51
	B4	3	14.69	7.51
	B4	4	14.69	7.53
	B4	5	14.69	7.53
	B4	6	14.69	7.60
	RB4	Roof	15.40	9.23
	B5	1	16.00	3.80
	B5	2	16.00	3.88
	B5	3	16.00	3.97
	B5	4	16.00	4.06
	B5	5	16.00	4.11
	B5	6	16.00	4.21
	RB5	Roof	16.00	3.59

**Table D21: Redesigned Column m-factors**

Column Removal	Column Label	Column Level	Vp/Vo	Governing m-factor	Column DCR	Joint DCR
1	C3	1	3.31	Force-Controlled	1.00	0.18
	C3-U1	2	2.61	Force-Controlled	0.86	0.17
	C3-U3	3	2.25	Force-Controlled	0.89	0.17
	C3-U3	4	2.05	Force-Controlled	0.98	0.17
	C3-U1	5	2.13	Force-Controlled	0.84	0.17
	C3-U1	6	1.90	Force-Controlled	0.91	0.17
	C3-U2	7	2.36	Force-Controlled	0.97	0.24
	C4	1	4.07	Force-Controlled	0.77	0.35
	C4	2	5.04	Force-Controlled	0.66	0.34
	C4	3	4.78	Force-Controlled	0.55	0.34
	C4	4	4.45	Force-Controlled	0.56	0.34
	C4	5	4.07	Force-Controlled	0.58	0.34
	C4	6	3.67	Force-Controlled	0.53	0.34
	C4	7	2.92	Force-Controlled	0.76	0.35
	C2-U4	1	6.07	Force-Controlled	0.98	0.65
	C2-U1	2	3.00	Force-Controlled	0.99	0.62





Column Removal	Column Label	Column Level	Vp/Vo	Governing m-factor	Column DCR	Joint DCR
	C2-U2	3	4.49	Force-Controlled	0.89	0.62
	C2-U2	4	4.32	Force-Controlled	0.91	0.62
	C2-U2	5	4.04	Force-Controlled	0.92	0.62
	C2-U2	6	3.70	Force-Controlled	0.83	0.62
	C2-U3	7	3.01	Force-Controlled	0.79	0.65
	-	1	-	-	-	0.51
	C1-U1	2	1.59	Force-Controlled	0.88	0.48
	C1-U2	3	2.65	Force-Controlled	0.85	0.48
	C1-U2	4	2.64	Force-Controlled	0.95	0.48
	C1-U2	5	2.64	Force-Controlled	0.94	0.48
	C1-U2	6	2.66	Force-Controlled	0.81	0.49
	C1-U3	7	4.17	Force-Controlled	1.00	0.57
2	C2-U5	1	4.47	Force-Controlled	0.99	0.65
	C2-U1	2	6.01	Force-Controlled	1.00	0.62
	C2-U2	3	5.92	Force-Controlled	0.92	0.62
	C2-U2	4	5.76	Force-Controlled	0.94	0.62
	C2-U2	5	5.39	Force-Controlled	0.95	0.62
	C2-U1	6	4.94	Force-Controlled	0.57	0.62
	C2-U6	7	3.97	Force-Controlled	0.99	0.65
	C4	1	4.07	Force-Controlled	0.77	0.35
	C4	2	5.04	Force-Controlled	0.66	0.34
	C4	3	4.78	Force-Controlled	0.55	0.34
	C4	4	4.45	Force-Controlled	0.56	0.34
	C4	5	4.07	Force-Controlled	0.58	0.34
	C4	6	3.67	Force-Controlled	0.53	0.34
	C4	7	2.92	Force-Controlled	0.77	0.35
	C4-U1	1	4.17	Force-Controlled	0.96	0.35
	C4-U2	2	5.12	Force-Controlled	0.96	0.34
	C4-U2	3	4.99	Force-Controlled	0.83	0.34
	C4-U2	4	4.78	Force-Controlled	0.85	0.34
	C4-U2	5	4.39	Force-Controlled	0.88	0.34
	C4-U2	6	3.91	Force-Controlled	0.94	0.34
	C4-U3	7	3.10	Force-Controlled	0.94	0.42
	C4	1	4.07	Force-Controlled	0.77	0.35
	C4	2	5.04	Force-Controlled	0.66	0.34
	C4	3	4.78	Force-Controlled	0.55	0.34
C4	4	4.45	Force-Controlled	0.56	0.34	



Column Removal	Column Label	Column Level	Vp/Vo	Governing m-factor	Column DCR	Joint DCR
	C4	5	4.07	Force-Controlled	0.58	0.34
	C4	6	3.67	Force-Controlled	0.53	0.34
	C4	7	2.92	Force-Controlled	0.77	0.35
	C2-U5	1	4.47	Force-Controlled	0.99	0.65
	C2-U6	2	6.01	Force-Controlled	0.94	0.62
	C2-U2	3	5.92	Force-Controlled	0.91	0.62
	C2-U2	4	5.76	Force-Controlled	0.93	0.62
	C2-U2	5	5.39	Force-Controlled	0.94	0.62
	C2-U1	6	4.94	Force-Controlled	0.56	0.62
	C2-U6	7	3.97	Force-Controlled	0.98	0.65
	-	1	-	-	-	0.88
	C2	2	3.68	Force-Controlled	0.84	0.84
	C2	3	3.68	Force-Controlled	0.49	0.84
	C2	4	3.67	Force-Controlled	0.54	0.84
	C2	5	3.66	Force-Controlled	0.53	0.84
	C2	6	3.68	Force-Controlled	0.47	0.85
	C2	7	3.44	Force-Controlled	0.72	0.99
	3	C3-U4	1	4.60	Force-Controlled	0.99
C3-U5		2	2.90	Force-Controlled	0.99	0.19
C3		3	4.11	Force-Controlled	0.94	0.19
C3		4	3.77	Force-Controlled	0.92	0.19
C3		5	3.31	Force-Controlled	0.92	0.19
C3		6	2.67	Force-Controlled	0.82	0.17
C3-U6		7	2.92	Force-Controlled	0.87	0.19
C4		1	4.07	Force-Controlled	0.68	0.35
C4		2	5.04	Force-Controlled	0.58	0.34
C4		3	4.77	Force-Controlled	0.49	0.34
C4		4	4.44	Force-Controlled	0.39	0.34
C4		5	4.07	Force-Controlled	0.29	0.34
C4		6	3.67	Force-Controlled	0.19	0.34
C4		7	2.91	Force-Controlled	0.22	0.35
C4		1	4.07	Force-Controlled	0.89	0.35
C4		2	5.04	Force-Controlled	0.75	0.34
C4		3	4.77	Force-Controlled	0.63	0.34
C4		4	4.44	Force-Controlled	0.50	0.34
C4		5	4.07	Force-Controlled	0.48	0.34
C4		6	3.67	Force-Controlled	0.43	0.34



Column Removal	Column Label	Column Level	Vp/Vo	Governing m-factor	Column DCR	Joint DCR
	C4	7	2.91	Force-Controlled	0.64	0.35
	C2	1	4.65	Force-Controlled	0.87	0.65
	C2	2	5.86	Force-Controlled	0.74	0.62
	C2	3	5.69	Force-Controlled	0.62	0.62
	C2	4	5.40	Force-Controlled	0.63	0.62
	C2	5	5.08	Force-Controlled	0.64	0.62
	C2	6	4.63	Force-Controlled	0.56	0.62
	C2	7	3.81	Force-Controlled	0.87	0.65
	C1	1	3.11	Force-Controlled	0.83	0.65
	C1	2	3.77	Force-Controlled	0.94	0.62
	C1	3	3.50	Force-Controlled	0.79	0.62
	C1	4	3.12	Force-Controlled	0.82	0.62
	C1	5	2.69	Force-Controlled	0.82	0.62
	C1	6	2.19	Force-Controlled	0.75	0.62
	C1-U4	7	2.78	Force-Controlled	0.83	0.65
	-	1	-	-	-	0.18
	C3-U2	2	2.39	Force-Controlled	0.80	0.17
	C3-U7	3	2.03	Force-Controlled	0.93	0.17
	C3-U7	4	2.78	Force-Controlled	0.99	0.17
	C3-U7	5	2.01	Force-Controlled	0.96	0.17
	C3-U7	6	1.98	Force-Controlled	0.92	0.17
	C3-U8	7	2.91	Force-Controlled	0.94	0.24

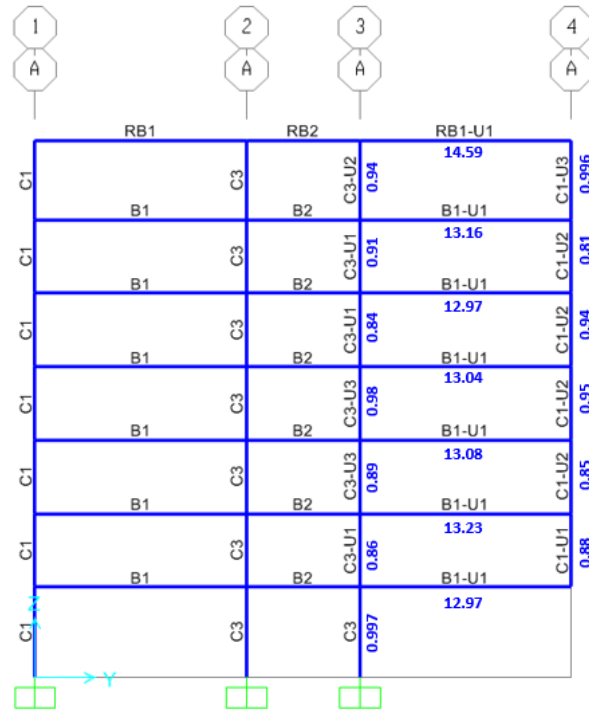


Figure D4.15: Column Removal 1 Upgraded Design along Gridline A

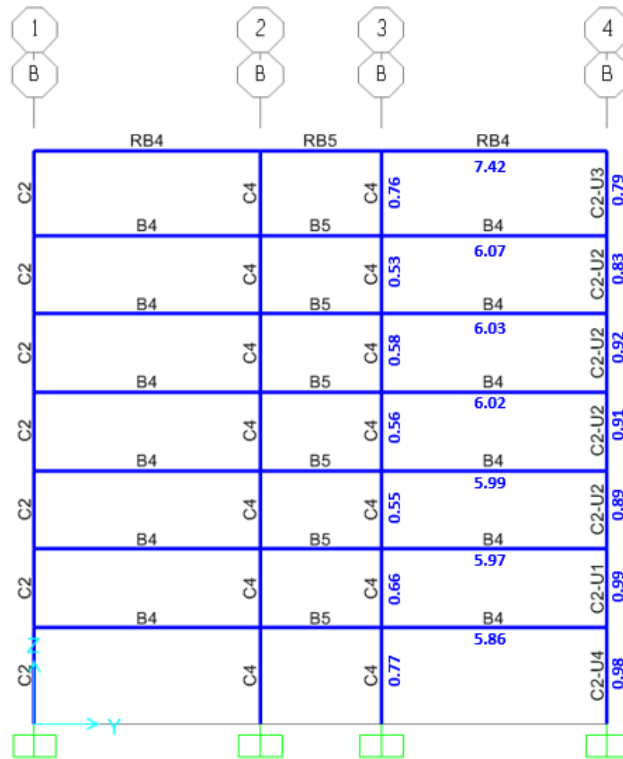


Figure D4.16: Column Removal 1 Upgraded Design along Gridline B

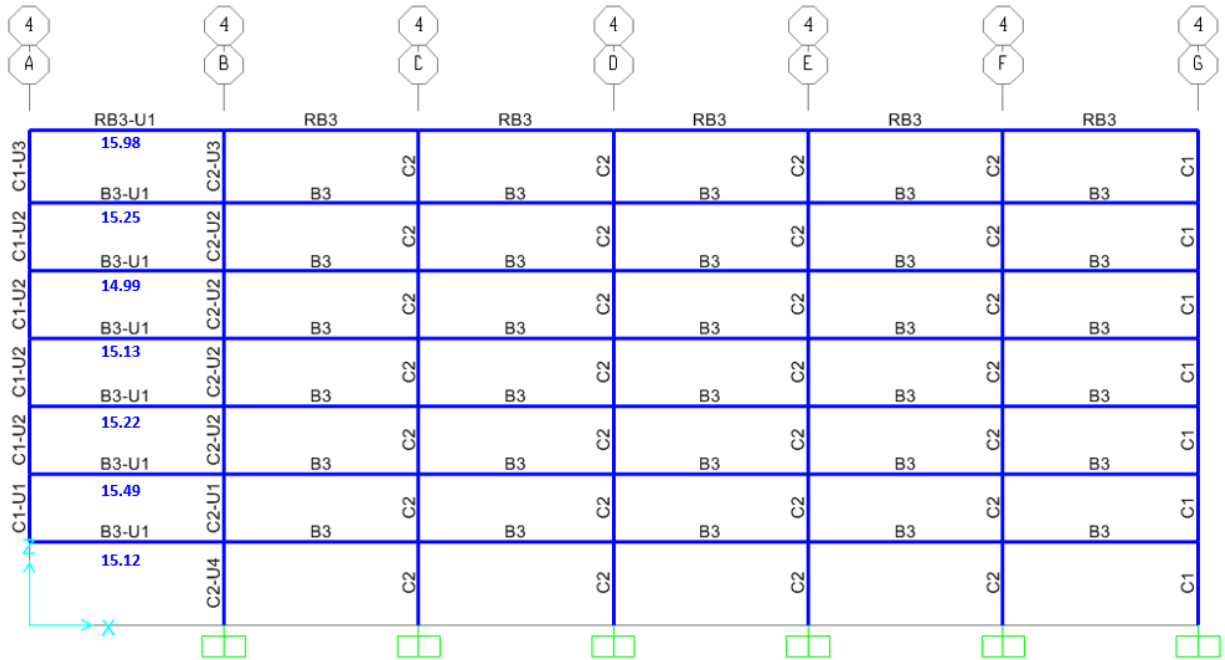


Figure D4.17: Column Removal 1 Upgraded Design along Gridline 4

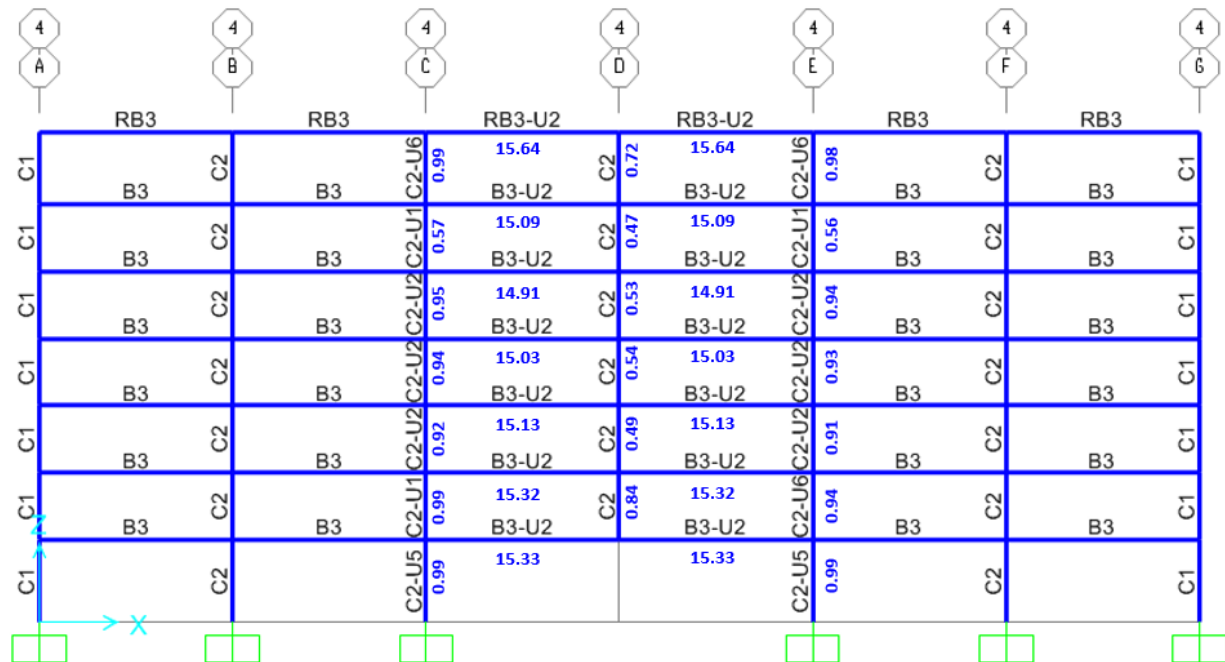


Figure D4.18: Column Removal 2 Upgraded Design along Gridline 4

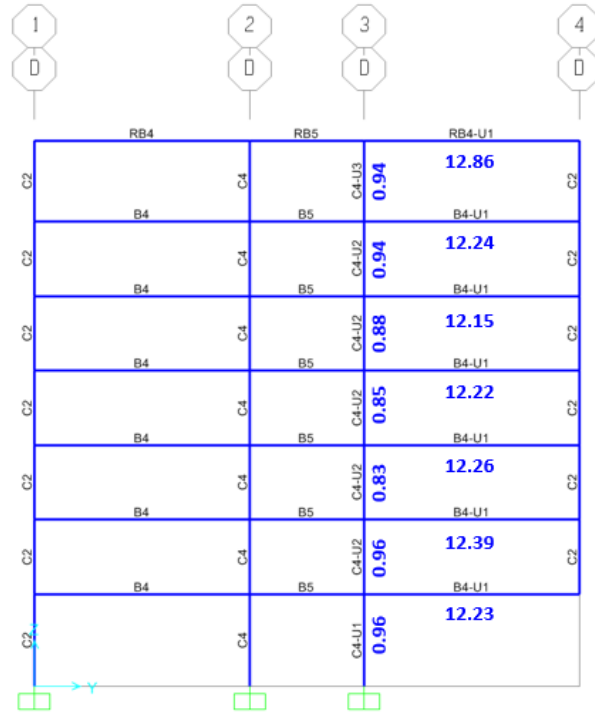


Figure D4.19: Column Removal 2 Upgraded Design along Gridline D

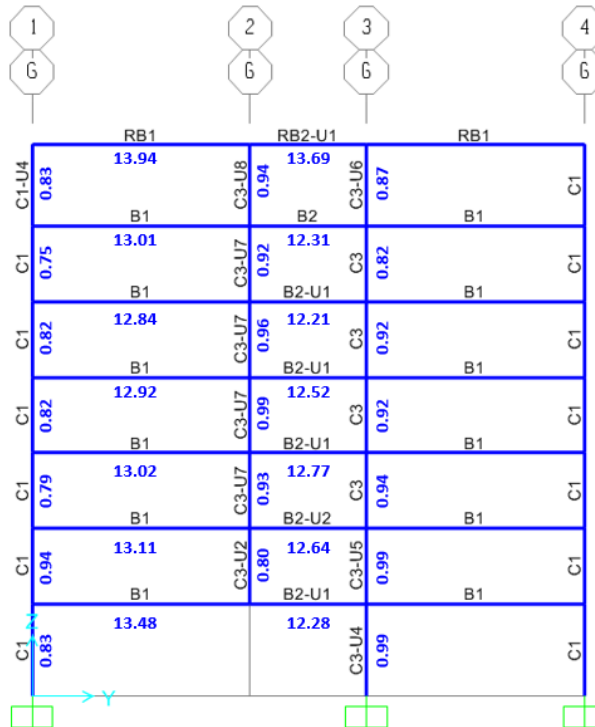
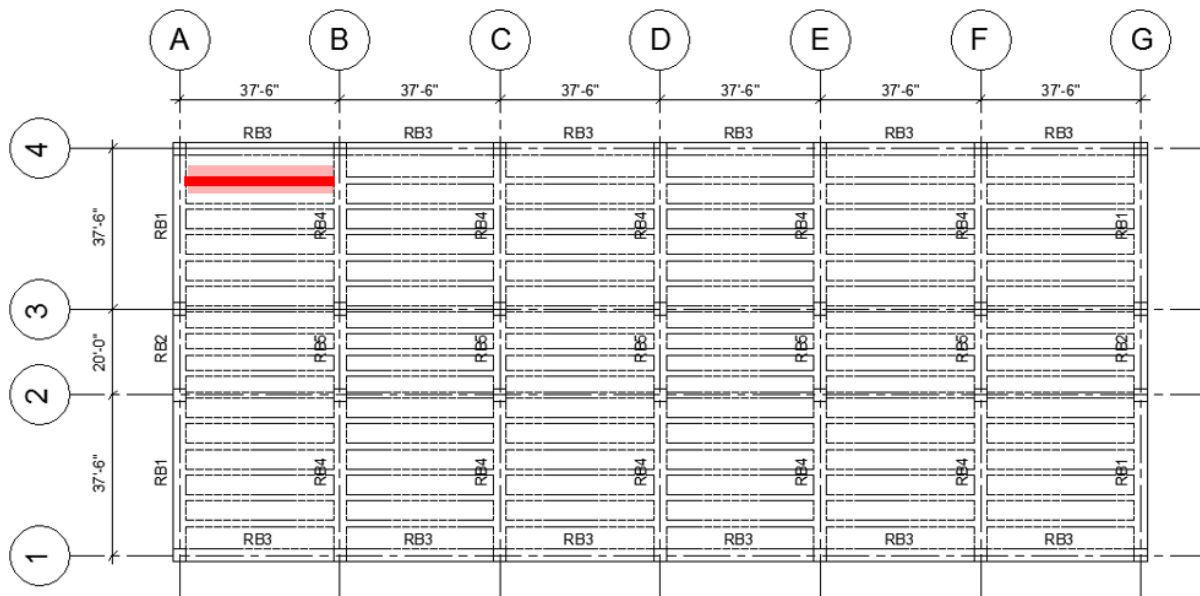


Figure D4.20: Column Removal 3 Upgraded Design along Gridline G

### D4.3.1 SECONDARY COMPONENT CHECKS

After verifying that all primary members satisfy the force- and deformation-controlled acceptance criteria, the secondary members must also be checked. The following calculations present the checks for a pan joist for column removal 1 shown in Figure D4.21.

Acceptance checks of secondary elements structures present a unique challenge within the framework of linear static analysis. While force- and deformation-controlled actions can be checked in a straight-forward manner with nonlinear procedures, the linear static procedure and criteria are based on m-factors applied to the moment and other deformation-controlled actions. As a result, actual forces (i.e. moments) must be determined to perform the checks. For the purposes of these Guidelines, reinforcement in the pan joist/slab is expected to develop into the supporting structure and therefore a fixed connection can be assumed and their flexural strength can be calculated using fixed end moments.



**Figure D4.21: Roof Plan showing Secondary Pan Joist Evaluated**

#### D4.3.1.1 DEFORMATION CONTROLLED ACTIONS

For the pan joist and the fixed connection, the deformation controlled actions are moments.

##### D4.3.1.1.1 PAN JOIST/SLAB

Pan joist are 20-in deep with a minimum width of 6-in and maximum width of 9.3-in. Joists are spaced at 6-ft on center with a 5-in slab between. Joists have positive reinforcement of (4) #9 as designed per gravity and slabs have #3 bars at 12-in on center:

$$\text{Joist Area, } A_{joist} = 20in \times \left( \frac{6in + 9.3in}{2} \right) = 153in^2$$

$$\text{Slab Area, } A_{slab} = 6ft * 5in = 360in^2$$



$$\text{Clear Span, } L_{clr} = 37.5\text{ft} - 36\text{in} = 414\text{in}$$

$$\text{Joist Reinforcement Area, } A_s = 4\text{in}^2$$

$$\text{Effective Width, } b_{eff} = 6\text{ft}$$

$$\text{Width of Web, } b_w = 7.625\text{in}$$

There are two contributions to the peak moment demand in the pan joist. The first is due to the factored linear static load corresponding to the pan joist's tributary area which includes the applicable load increase factors used in the original linear static analysis. This is required because while the pan joist is not explicitly included in the linear static model, it will experience dynamic and nonlinear effects, which the load increase factors capture. This is calculated using Equation 3.3:

$$\begin{aligned} w &= G_{LD} = \Omega_{LD} [1.2D + (0.5L \text{ or } 0.2S)] \\ &= 12.5 [1.2 (SW + DL_{floor}) + 0.5(LL_{floor})] = 19.6 \text{ kip/ft} \end{aligned}$$

where  $\Omega_{LD}$  = Load increase factor = 12.5 for column removal 1

$$SW = \text{Self weight} = 150 \text{ pcf} \times (153\text{in}^2 + 360\text{in}^2) = 534.4 \text{ lb/ft}$$

$$DL_{floor} = \text{Dead load of floor over tributary area of gravity beam} = 99 \text{ psf} \times 6 \text{ ft}$$

$$LL_{floor} = \text{Live load of floor over tributary area of gravity beam} = 70 \text{ psf} \times 6 \text{ ft}$$

The second contribution is the end moment created by the displacement at the pan joist fixed connections, as determined from the linear static analysis under the considered column removal. The relative displacement is the difference between the displacements of the beams on either side of the secondary element at the location where the secondary element connects to the primary beam. This example is evaluating the pan joist adjacent to the column removal, located 6-ft from the centerline of Gridline 4. The displacements for this example are shown in the screenshots in Figure D4.22 and Figure D4.23.



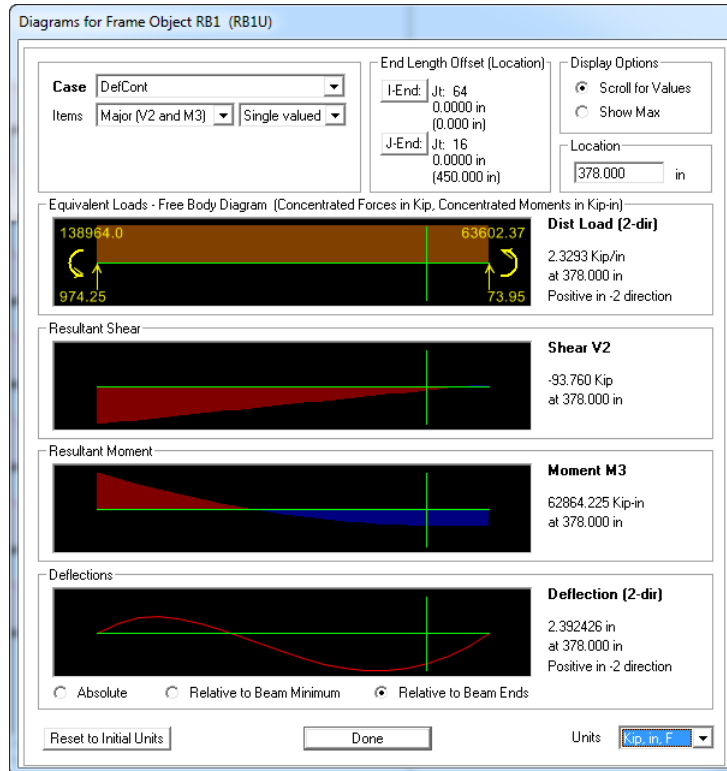


Figure D4.22: Displacement of Girder along to Gridline A with Deformation Controlled Action

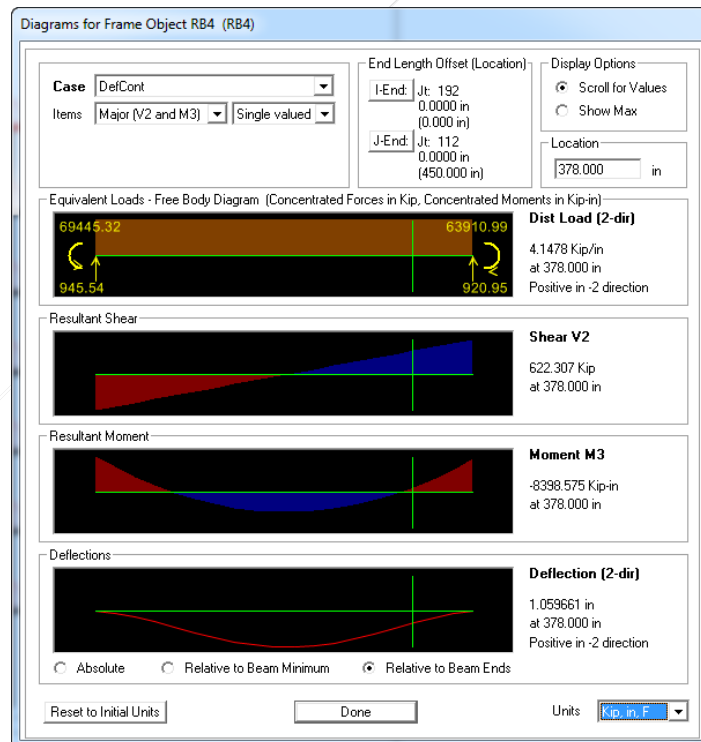


Figure D4.23: Displacement of Girder along to Gridline B with Deformation Controlled Action

The relative displacement is calculated as:

$$\Delta = \Delta_{Ext} - \Delta_{Int} = 2.39 \text{ in} - 1.06 \text{ in} = 1.33 \text{ in}$$

where,

$\Delta =$  Relative Displacement

$\Delta_{Int} =$  Displacement of beam along interior gridline at location of pan joist connection

$\Delta_{Ext} =$  Displacement of beam along exterior gridline at location of pan joist connection

The fixed end moment is then calculated as:

$$M = \frac{6E_c I_{cr} \Delta}{L_{ctr}^2}$$

where,

$E_c =$  Modulus of Elasticity of the Concrete

$I_{cr} =$  Cracked Moment of Inertia of the Transformed Section =  $0.3I_g = 0.3 * 37586 \text{ in}^4$

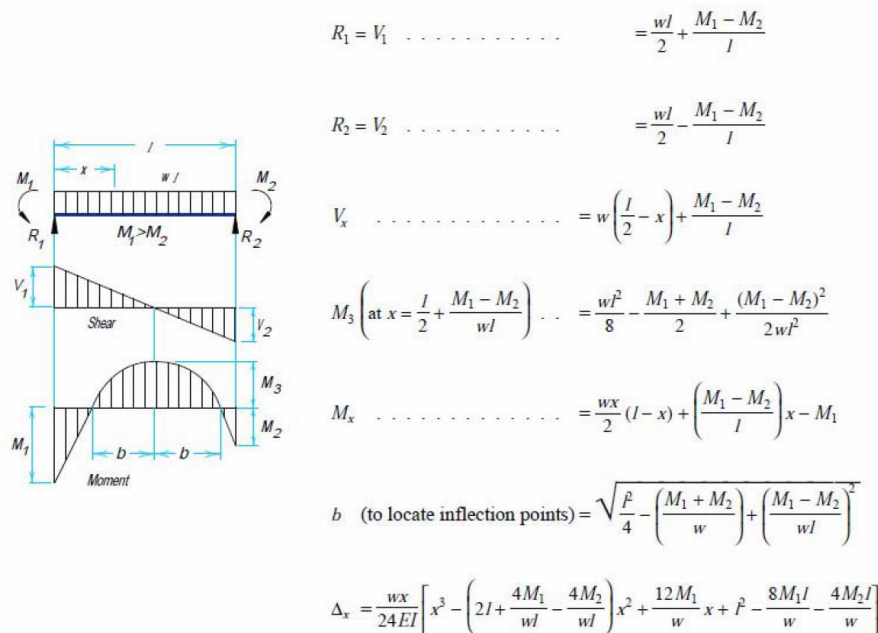
$\Delta =$  Relative displacement

$L_{ctr} =$  Joist Clear Span = 34.5 ft = 414 in

The end moment demand is then calculated as:

$$M = \frac{6 * 4031 \text{ ksi} * 11276 \text{ in}^4 * 1.33 \text{ in}}{(414 \text{ in})^2} = 2116.3 \text{ kip in} = 176.4 \text{ kip ft}$$

The combination of end moments and uniform load corresponds to the loading case shown in Figure D4.24, which is taken from AISC LRFD design manual [21].



**Figure D4.24: Shear & Moment in Simply-Supported Beam with End Moments and Uniform Loading**



The maximum moment demand is found using the equation for  $M_3$  in Figure D4.24:

$$M_3 = \frac{wL^2}{8} - \frac{(M_1 + M_2)}{2} + \frac{(M_1 - M_2)^2}{2wL^2}$$

$$M_3 = \frac{19.6 \frac{\text{kip}}{\text{ft}} * (34.5 \text{ ft})^2}{8} - \frac{176.4 \text{ kip ft} + 176.4 \text{ kip ft}}{2} + \frac{(176.4 \text{ kip ft} - 176.4 \text{ kip ft})^2}{2 * 19.6 \frac{\text{kip}}{\text{ft}} * (34.5 \text{ ft})^2}$$

$$M_3 = Q_{UD} = 2740 \text{ kip ft}$$

This is the demand ( $Q_{UD}$ ) for the pan joist. The expected moment strength for the pan joist is calculated as follows:

$$a = \frac{A_s f_{ye}}{0.85 f'_c b} = \frac{4.0 \text{ in}^2 * 75 \text{ ksi}}{0.85 * 5 \text{ ksi} * 72 \text{ in}} = 0.98 \text{ in}$$

$$Q_{CE} = F_y A_s \left( d - \frac{a}{2} \right) = 1.25 * 60 \text{ ksi} * 4.0 \text{ in}^2 * \left( 21 \text{ in} - \frac{0.98 \text{ in}}{2} \right) = 512.7 \text{ kip ft}$$

where,

$Q_{CE}$  = Expected strength of the pan joist

$\Omega$  = Overstrength factor = 1.25 from ASCE 41 – 16 Table 10 – 1

$F_y$  = Yield strength = 60 ksi

$A_s$  = Area of steel

$d$  = Depth to centroid of reinforcing

Comparing the DCR with the corresponding m-factor ( $m = 5.0$ ) calculated as per Section D4.3:

$$\Phi m Q_{CE} \geq Q_{UD}$$

$$0.9(5.0)(512.7 \text{ kip ft}) = 2307.4 \text{ kip ft} \geq 2116.3 \text{ kip ft}$$

**OK**

#### D4.3.1.2 FORCE CONTROLLED ACTIONS

For the pan joist with a fixed connection the force-controlled action is shear. The calculation of the peak shear demand in the pan joist and the connection is calculated similar to the moment in the previous section; however results from the force-controlled model are used.

##### D4.3.1.2.1 GRAVITY BEAM

There are two contributions to the peak moment demand in the pan joist. The first is due to the factored linear static load corresponding to the joist's tributary area, which includes the applicable load increase factors used in the original linear static analysis.

The distributed load on the pan joist is the factored linear static load as calculated with Equation 3.5:

$$w = G_{LF} = \Omega_{LF} [1.2D + (0.5L \text{ or } 0.2S)]$$

$$w = G_{LF} = 2 [1.2 (SW + DL_{floor}) + 0.5(LL_{floor})] = 3.13 \text{ kip/ft}$$

The second contribution is the end moment created by joist stiffness and the relative displacement at the end of the beam, as determined from the linear static analysis under the considered column removal. The relative displacement is the difference between the displacements of the beams on either side of the secondary element at the location where the secondary element connects to the primary beam. The displacements for this example are shown in the screenshots in Figure D4.25 and Figure D4.26.

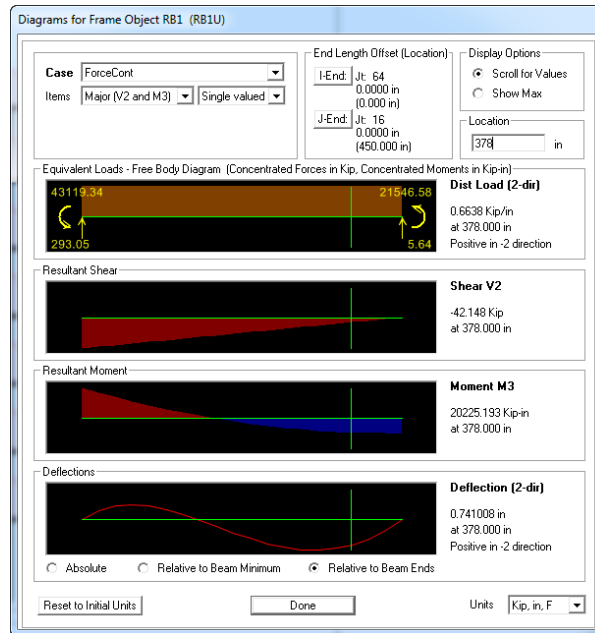


Figure D4.25: Displacement of Beam along Gridline A with Force Controlled Action

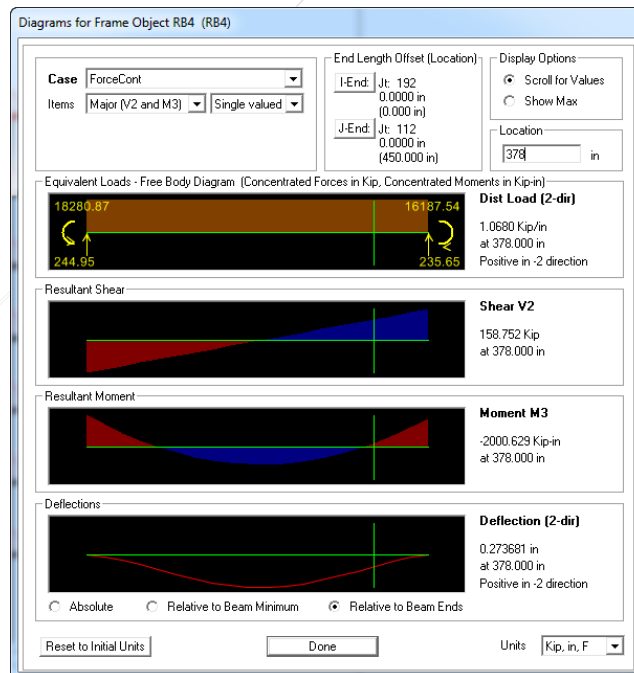


Figure D4.26: Displacement of Beam along Gridline B with Force Controlled Action



The relative displacement is calculated as:

$$\Delta = \Delta_{Ext} - \Delta_{Int} = 0.74 \text{ in} - 0.27 \text{ in} = 0.47 \text{ in}$$

where,

$\Delta =$  Relative Displacement

$\Delta_{Int} =$  Displacement of beam along interior gridline at location of pan joist connection

$\Delta_{Ext} =$  Displacement of beam along exterior gridline at location of pan joist connection

The fixed end moment is then calculated as:

$$M = \frac{6E_c I_{cr} \Delta}{L_{clr}^2}$$

where,

$E_c =$  Modulus of Elasticity of the Concrete

$I_{cr} =$  Cracked Moment of Inertia of the Transformed Section =  $0.3I_g = 0.3 * 37586 \text{ in}^4$

$\Delta =$  Relative displacement

$L_{clr} =$  Joist Clear Span =  $34.5 \text{ ft} = 414 \text{ in}$

The end moment demand is then calculated as:

$$M = \frac{6 * 4031 \text{ ksi} * 11276 \text{ in}^4 * 0.47 \text{ in}}{(414 \text{ in})^2} = 747.8 \text{ kip in} = 62.3 \text{ kip ft}$$

The maximum shear demand is found using the equation for  $V_1$  in Figure D4.24:

$$V_1 = \frac{wL_{clr}}{2} + \frac{M_1 + M_2}{L_{clr}}$$

$$V_1 = \frac{3.13 \frac{\text{kip}}{\text{ft}} * 34.5 \text{ ft}}{2} + \frac{62.3 \text{ kip ft} + 62.3 \text{ kip ft}}{34.5 \text{ ft}}$$

$$V_1 = 57.6 \text{ kips}$$

This is the demand or  $V_{UF}$  for the pan joist. For a concrete section, the lower bound shear strength is:

$$V_{CL} = \frac{A_v f_y d}{s} = \frac{0.2 * 60 \text{ ksi} * 21 \text{ in}}{6 \text{ in}} = 42 \text{ kips}$$

where,

$A_v =$  Shear area = 1 Leg of #4 =  $0.2 \text{ in}^2$

$d =$  Depth to centroid of reinforcement =  $21 \text{ in}$

$s =$  Spacing of shear bars =  $6 \text{ in}$

Checking Equation 3-13:

$$\Phi Q_{CL} \geq Q_{UF}$$

$$0.75(80 \text{ kips}) = 42 \text{ kips} \leq 57.6 \text{ kips}$$

**NG**



Thus, the shear strength of the single leg stirrup is not sufficient and must be increased. Since the baseline design strength is based on conventional design load combination (1.2D + 1.6L) and the demand is based on the modified extreme load combination (1.2D + 0.5L) multiplied by the  $\Omega$ LF of 2, this is not unexpected. Therefore, the shear strength of the pan joist must be increased to 58 kips. This can be done by reducing the spacing of the single leg stirrup to 4-in on center.

Note that the axial force in these secondary elements and connections and the performance of the concrete slab are considered sufficient based on inspection due to the small rotations and are not explicitly evaluated.

## D5 REDUNDANCY REQUIREMENTS

The intent of redundancy requirements is to prevent structural designs where progressive collapse resistance is localized at one floor and to encourage balanced and redundant designs that distribute resistance up the height of the building. For the purpose of this example, only Column Removal 1 is considered; however in actual application, redundancy requirements shall be applied at each exterior column removal location.

### D5.1 LOCATION REQUIREMENTS

Load redistribution systems must be spaced vertically along the height of the structure and the spacing between the systems must not exceed three floors. A redistribution system is defined as a structural system that has the capability to redistribute gravity loads to adjacent vertical structural elements under the loss of a column or load-bearing wall.

The number of load redistribution systems in the structure,  $n$ , must meet Equation 3.13:

$$n \geq \frac{N}{3}$$

where,

$n$  = Number of vertical load redistribution systems

$N$  = Total number of floors

For the eight-story building utilized in this example,  $n$  is required to be:

$$n \geq \frac{8}{3} = 2.67$$

Rounding up to the nearest integer:  $n = 3$

Therefore, three load redistribution systems are required. For the purposes of this example, it is the systems are located at Level 3, Level 5, and Level 7; however in general, the location of load redistribution systems is at the discretion of the designer, provided it meets the minimum spacing requirement of three floors.

### D5.2 STRENGTH REQUIREMENTS

The strength of each vertical load redistribution system must meet the following equation:



$$\left| \frac{Q_{Ri} - \overline{Q}_R}{\overline{Q}_R} \right| \leq 0.3$$

where,

$Q_{Ri} = \sum \Phi Q_C =$  *Design strength of a given load redistributing system at a single floor level associated with the exterior ground level column and/or wall plan removal location under construction.*

$Q_C =$  *Expected strength of a component or element contributing to strength of a load redistribution system at a single floor level associated with the exterior ground level column and/or wall plan removal location under construction.*

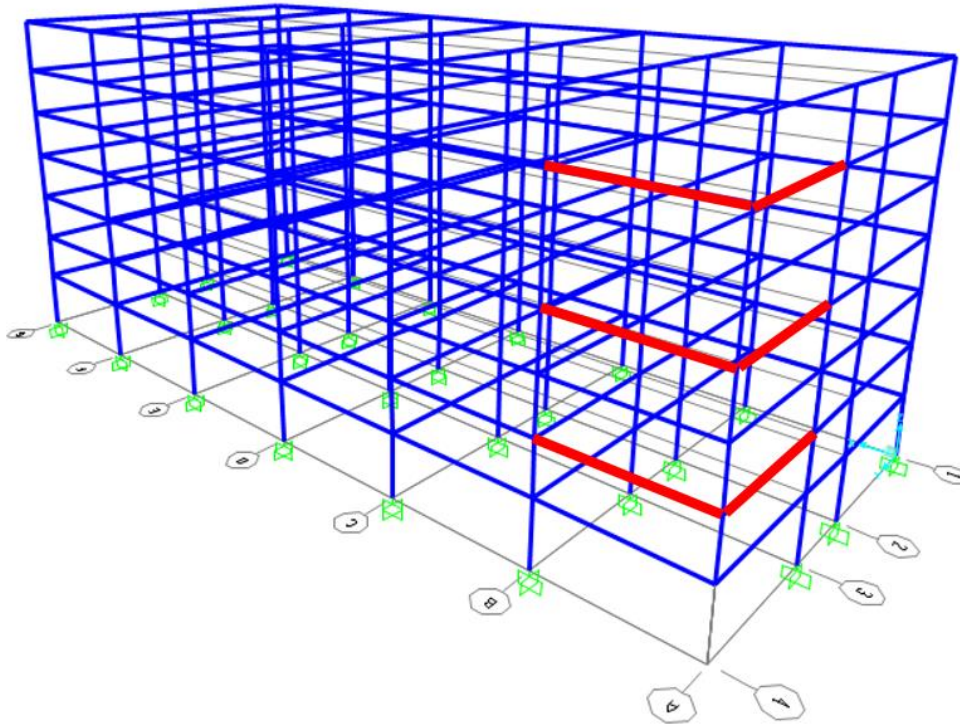
$\overline{Q}_R = \frac{\sum_{i=1}^n Q_{Ri}}{n} =$  *Average design strength of load redistributing systems up the height of the building associated with the exterior ground level column and/or wall plan removal location under construction.*

$\Phi =$  *Strength reduction factor from the appropriate material specific code*

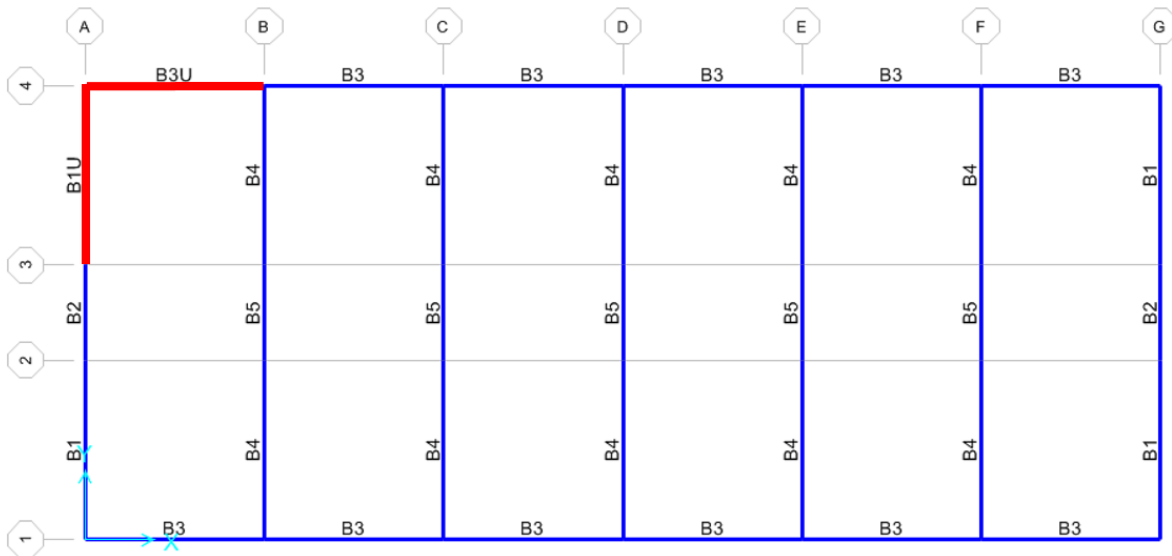
The load redistribution system should include all primary horizontal members contributing to the redistribution of the gravity loads. The extent of the horizontal members included in the load redistribution system at a given plan location should be limited to a single structural bay perpendicular to and in either direction of the column removal location.

#### D5.2.1 COLUMN REMOVAL 1

The extent of horizontal members contributing to the vertical load redistribution system at Column Removal 1 is shown in the 3D isometric in Figure D5.1 and at plan location for Level 3, 5, and 7 (Figure D5.2).



**Figure D5.1: Load Redistribution System for Column Removal 1**



**Figure D5.2: Load Redistribution System at Level 3, 5, and 7 for Column Removal 1**

The design strength of each horizontal element contributing to the vertical load distribution system at Level 3 is calculated as the minimum of the beam or its connections. For the moment frame elements, the connection is assumed to be capable of developing the moment capacity of the beam; therefore the design strength of the element is governed by the beam section itself:





$$(Q_{C1})_3 = \Phi M_{nB1U} = 0.9 \left[ 60 \text{ksi} * 12 \text{in}^2 \left( 22.5 \text{in} - \frac{3.53 \text{in}}{2} \right) \right] = 839.8 \text{ kip in}$$

$$(Q_{C2})_3 = \Phi M_{nB3U} = 0.9 \left[ 60 \text{ksi} * 4.2 \text{in}^2 \left( 22.5 \text{in} - \frac{6.32 \text{in}}{2} \right) \right] = 604.6 \text{ kip in}$$

where,

$$\Phi = \text{Strength reduction factor for concrete in bending} = 0.9$$

$$M_n = \text{Moment capacity of beam} = A_s f_y \left( d - \frac{a}{2} \right)$$

The total design strength for the vertical load redistribution system at Level 3 is the sum of all contributing elements:

$$Q_{R3} = \sum \Phi Q_C = (Q_{C1})_3 + (Q_{C2})_3 = 839.8 \text{ kip in} + 604.6 \text{ kip in}$$

$$Q_{R3} = 1444.4 \text{ kip in}$$

Similarly, the design strength of each horizontal element contributing to the vertical load distribution system at Level 5 is calculated as:

$$(Q_{C1})_5 = \Phi M_{nB1U} = 839.8 \text{ kip in}$$

$$(Q_{C2})_5 = \Phi M_{nB3U} = 604.6 \text{ kip in}$$

And the total design strength for the vertical load redistribution system at Level 5 is the sum of all contributing elements:

$$Q_{R5} = \sum \Phi Q_C = (Q_{C1})_5 + (Q_{C2})_5 = 1444.4 \text{ kip in}$$

The design strength of each horizontal element contributing to the vertical load distribution system at Level 7 is calculated as:

$$(Q_{C1})_7 = \Phi M_{nB1U} = 839.8 \text{ kip in}$$

$$(Q_{C2})_7 = \Phi M_{nB3U} = 604.6 \text{ kip in}$$

And the total design strength for the vertical load redistribution system at Level 7 is the sum of all contributing elements:

$$Q_{R7} = \sum \Phi Q_C = (Q_{C1})_7 + (Q_{C2})_7 = 1444.4 \text{ kip in}$$

The average design strength is the average strength of all the vertical load redistribution systems for the column removal, which for this example, is Level 3, Level 5, and 7 only.

$$\overline{Q_R} = \frac{\sum_{i=1}^n Q_{Ri}}{n} = \frac{Q_{R3} + Q_{R5} + Q_{R7}}{3} = \frac{1444.4 \text{ kip in} + 1444.4 \text{ kip in} + 1444.4 \text{ kip in}}{3}$$

$$\overline{Q_R} = 1444.4 \text{ kip in}$$

The difference between the design strength at each floor and the average is calculated to verify it is within the 30% acceptable variance:



$$\left| \frac{Q_{Ri} - \overline{Q}_R}{\overline{Q}_R} \right| \leq 0.3$$

For Level 3:

$$\left| \frac{1444.4 \text{ kip in} - 1444.4 \text{ kip in}}{1444.4 \text{ kip in}} \right| = 0.0 \leq 0.3 \quad \text{OK}$$

For Level 5:

$$\left| \frac{1444.4 \text{ kip in} - 1444.4 \text{ kip in}}{1444.4 \text{ kip in}} \right| = 0.0 \leq 0.3 \quad \text{OK}$$

For Level 7:

$$\left| \frac{1444.4 \text{ kip in} - 1444.4 \text{ kip in}}{1444.4 \text{ kip in}} \right| = 0.0 \leq 0.3 \quad \text{OK}$$

### D5.3 STIFFNESS REQUIREMENTS

The strength of each vertical load redistribution system must meet the following equation:

$$\left| \frac{K_{Ri} - \overline{K}_R}{\overline{K}_R} \right| \leq 0.3$$

where,

$K_{Ri} = \sum K_{CE} =$  Flexural stiffness of a given load redistributing system  
at a single floor level associated with the exterior ground level column and/or  
wall plan removal location under construction.

$K_{CE} =$  Flexural stiffness of a component or element contributing to strength  
of a load redistribution system at a single floor level associated with the exterior  
ground level column and/or wall plan removal location under construction.

$\overline{K}_R = \frac{\sum_{i=1}^n K_{Ri}}{n} =$  Average flexural stiffness of load redistributing systems up the height of the  
building associated with the exterior ground level column and/or wall plan removal  
location under construction.

#### D5.3.1 COLUMN REMOVAL 1

The same two horizontal members used to evaluate the strength of the vertical load redistribution system are used to evaluate the stiffness.

The stiffness of each horizontal element contributing to the vertical load distribution system at Level 3 is calculated based on the boundary conditions of the element, prior to the column removal. Reinforcement continues through the connections such that support conditions can be assume to be fix-fix.

$$K_{CE1} = \frac{384 E_c I_{cr.B1U}}{L_1^3} = \frac{384 * 4031 \text{ ksi} * 19160 \text{ in}^4}{(450 \text{ in})^3} = 279 \frac{\text{kip}}{\text{in}}$$



$$K_{CE2} = \frac{384 E_c I_{cr.B3U}}{L_2^3} = \frac{384 * 4031 \text{ ksi} * 14631 \text{ in}^4}{(450 \text{ in})^3} = 249 \frac{\text{kip}}{\text{in}}$$

Where,

$$E_c = \text{Modulus of Elasticity of Concrete} = 4031 \text{ ksi}$$

$$I_{cr.B1U} = \text{Cracked Moment of Inertia Beam B1U} = 0.3I_g = 16423 \text{ in}^4$$

$$I_{cr.B3U} = \text{Cracked Moment of Inertia Beam B3U} = 0.3I_g = 14631 \text{ in}^4$$

$$L_1 = L_2 = \text{Length of Beam} = 37.5 \text{ ft} = 450 \text{ in}$$

The total stiffness for the vertical load redistribution system at Level 3 is the sum of all contributing elements:

$$K_{R3} = \sum K_{CE} = K_{CE1} + K_{CE2} = 279 \frac{\text{kip}}{\text{in}} + 249 \frac{\text{kip}}{\text{in}}$$

$$K_{R3} = 528 \frac{\text{kip}}{\text{in}}$$

Similarly, the stiffness of each horizontal element contributing to the vertical load distribution system at Level 5 is calculated as:

$$K_{CE1} = \frac{384 E_c I_{cr.B1U}}{L_1^3} = \frac{384 * 4031 \text{ ksi} * 16423 \text{ in}^4}{(450 \text{ in})^3} = 279 \frac{\text{kip}}{\text{in}}$$

$$K_{CE2} = \frac{384 E_c I_{cr.B3U}}{L_2^3} = \frac{384 * 4031 \text{ ksi} * 14631 \text{ in}^4}{(450 \text{ in})^3} = 249 \frac{\text{kip}}{\text{in}}$$

The total stiffness for the vertical load redistribution system at Level 5 is the sum of all contributing elements:

$$K_{R5} = \sum K_{CE} = K_{CE1} + K_{CE2} = 279 \frac{\text{kip}}{\text{in}} + 249 \frac{\text{kip}}{\text{in}}$$

$$K_{R5} = 528 \frac{\text{kip}}{\text{in}}$$

The stiffness of each horizontal element contributing to the vertical load distribution system at Level 7 is calculated as:

$$K_{CE1} = 279 \frac{\text{kip}}{\text{in}}$$

$$K_{CE2} = 249 \frac{\text{kip}}{\text{in}}$$

The total stiffness for the vertical load redistribution system at Level 7 is the sum of all contributing elements:

$$K_{R7} = \sum K_{CE} = 279 \frac{\text{kip}}{\text{in}} + 249 \frac{\text{kip}}{\text{in}}$$

$$K_{R7} = 528 \frac{\text{kip}}{\text{in}}$$



The average stiffness is that for all the vertical load redistribution systems for the column removal, which for this example, is Level 3, 5, and 7 only.

$$\overline{K_R} = \frac{\sum_{i=1}^n K_{Ri}}{n} = \frac{K_{R3} + K_{R5} + K_{R7}}{3} = \frac{528 \frac{\text{kip}}{\text{in}} + 528 \frac{\text{kip}}{\text{in}} + 528 \frac{\text{kip}}{\text{in}}}{3}$$
$$\overline{K_R} = 528 \frac{\text{kip}}{\text{in}}$$

The difference between the stiffness at each floor and the average is calculated to verify it is within the 30% acceptable variance:

$$\left| \frac{K_{Ri} - \overline{K_R}}{\overline{K_R}} \right| \leq 0.3$$

For Level 3:

$$\left| \frac{528 \frac{\text{kip}}{\text{in}} - 528 \frac{\text{kip}}{\text{in}}}{528 \frac{\text{kip}}{\text{in}}} \right| = 0.0 \leq 0.3 \quad \text{OK}$$

For Level 5:

$$\left| \frac{528 \frac{\text{kip}}{\text{in}} - 528 \frac{\text{kip}}{\text{in}}}{528 \frac{\text{kip}}{\text{in}}} \right| = 0.0 \leq 0.3 \quad \text{OK}$$

For Level 7:

$$\left| \frac{528 \frac{\text{kip}}{\text{in}} - 528 \frac{\text{kip}}{\text{in}}}{528 \frac{\text{kip}}{\text{in}}} \right| = 0.0 \leq 0.3 \quad \text{OK}$$



# **APPENDIX E**

## **STRUCTURAL STEEL EXAMPLE**





## TABLE OF CONTENTS

<b>E1 INTRODUCTION .....</b>	<b>E1</b>
<b>E2 BASELINE PRELIMINARY DESIGN .....</b>	<b>E1</b>
E2.1 DESIGN AND MODELING ASSUMPTIONS.....	E1
E2.1.1 CONNECTIONS.....	E1
E2.1.2 ELEMENTS.....	E2
E2.1.3 LOADING .....	E2
E2.1.4 MEMBER SIZES.....	E3
<b>E3 LINEAR STATIC PROCEDURE.....</b>	<b>E9</b>
E3.1 DCR AND IRREGULARITY CHECK .....	E9
E3.2 COLUMN REMOVAL LOCATIONS.....	E9
E3.3 ANALYTICAL MODELING.....	E10
E3.3.1 PRIMARY AND SECONDARY ELEMENT CLASSIFICATION .....	E10
E3.3.2 CLASSIFICATION OF DEFORMATION AND FORCE-CONTROLLED ACTIONS.....	E10
E3.3.3 M-FACTORS.....	E11
E3.3.4 LOAD INCREASE FACTORS .....	E15
E3.3.5 LOAD COMBINATIONS.....	E16
<b>E4 ALTERNATIVE PATH ANALYSIS .....</b>	<b>E17</b>
E4.1 DEVELOP PRELIMINARY MODEL .....	E17
E4.2 DEFINE LOAD CASES AND ASSIGN LOADS.....	E18
E4.3 RUN ANALYSIS AND COMPARE TO ACCEPTANCE CRITERIA .....	E20
E4.3.1 SECONDARY COMPONENT CHECKS .....	E30
<b>E5 REDUNDANCY REQUIREMENTS.....</b>	<b>E38</b>
E5.1 LOCATION REQUIREMENTS .....	E38
E5.2 STRENGTH REQUIREMENTS.....	E38
E5.2.1 COLUMN REMOVAL 1.....	E39
E5.3 STIFFNESS REQUIREMENTS.....	E42
E5.3.1 COLUMN REMOVAL 1.....	E42



## E1 INTRODUCTION

This design example is based on the baseline preliminary design utilized in Appendix E of UFC for a typical four-story steel frame facility located in a non-seismic region. For the purposes of this example, it is assumed that the building is GSA-owned, new construction, and functions as a high occupancy office space for GSA tenants, which require a Facility Security Level (FSL) IV. The building has a controlled lobby and no below-grade parking. Based on the Applicability requirements of Chapter 2, the potential for progressive collapse must be considered and both the Alternate Path and Redundancy Requirements shall be applied.

This example was prepared using tools and techniques commonly applied by structural engineering firms in the U.S. To illustrate the various options given in these Guidelines, the example is prepared using the linear static and nonlinear dynamic analysis procedures.

## E2 BASELINE PRELIMINARY DESIGN

The baseline design presented in the UFC [31] is adopted for this example with minor modifications. The structure is a four-story steel structure with perimeter moment frames and an interior braced frame in the transverse direction. The baseline design, shown in Figure E2.3 through Figure E2.6 was sized to meet the requirements of the International Building Code (IBC) 2006 [20]. In addition, the lateral drift of the frame was evaluated for a performance limit of  $L/400$  under a 10-year wind. Given its location in a non-seismic region, it is assumed that wind governs the design of the lateral system and the building does not need to meet the seismic provisions of AISC 341 [6].

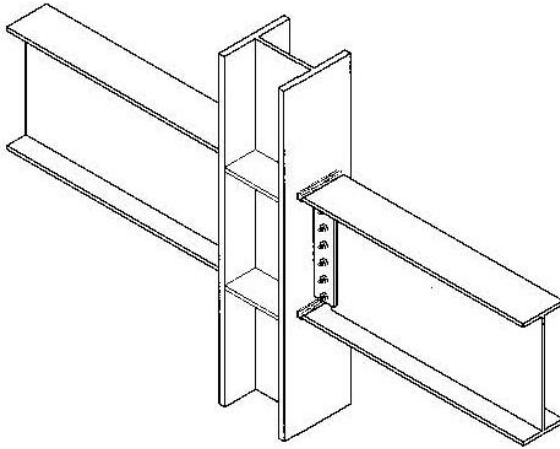
### E2.1 DESIGN AND MODELING ASSUMPTIONS

#### E2.1.1 CONNECTIONS

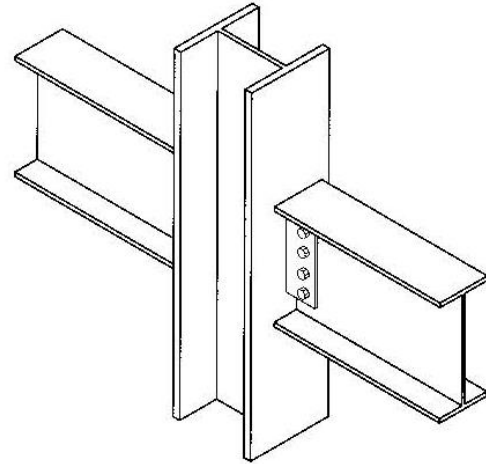
**Moment Connections:** The baseline design includes perimeter moment frames with moment connections at all beam elements, with the exception of those that connect to the column weak-axis. The typical moment connection is an improved WUF with bolted web, as shown in Figure E2.1.

**Gravity Connections:** The typical gravity frame connection is a simple shear tab, similar to that shown in Figure E2.2, with a 3/8-in plate with 1/4-in weld, (4) 3/4-in A325N bolts and a 9-in depth of bolt group. Although a simple shear tab connection has some rotational stiffness and can be characterized as a partially restrained moment connection, for the purposes of the baseline design, all gravity connections are assumed to be pin-pin. Additional discussion of the modeling and acceptance criteria of this type of connection is provided in the secondary components check in Paragraph E4.3.1 of this example.

**Column Connections:** For the purposes of the Alternate Path analysis, columns are assumed to be continuous over the height of the structure and to have a pinned connection at the foundation. For the purposes of the Redundancy analysis, columns are assumed to be spliced at every two floors for purposes of calculating splice design loads for collector elements.



**Figure E2.1: WUF Connection w/ Bolted Web**



**Figure E2.2: Simple Shear Tab Connection**

### E2.1.2 ELEMENTS

Floor and Roof Decking: The roof is bare metal deck with no concrete fill. Floor systems are 3-in composite metal deck with a 4.5-in concrete topping for a total slab thickness of 7.5-in. Both the floor and roof system were modeled as rigid diaphragms and were assumed to be non-composite with the steel framing.

Steel Framing: All steel framing is ASTM A992 and designed as non-composite sections. Members were represented by centerline elements with zero end offsets to account for joint flexibility.

### E2.1.3 LOADING

The dead and live loads used in developing the baseline preliminary design are summarized in Table E22. The wind load (W) was determined in accordance with IBC 2006 [20] using a 110-mph with exposure = B and an importance factor of 1.15. The earthquake load (E) is not considered as the building is assumed to be in a non-seismic region with wind governing the lateral design. Other loads, including snow (S) and rain (R) are also assumed to not control the design.

**Table E22: Gravity Loading**

	Roof	Floor
<b>Dead Load (D)</b>		
Self-Weight of Members	Variable	Variable
Composite Metal Deck w/ 7-.5-in Normal Weight Concrete	-	78-psf
Bare Metal Deck	5-psf	-
Superimposed Dead Load	15-psf	15 psf
Cladding on Building Perimeter (CL)	15-psf (220-plf)	15-psf (220-plf)
<b>Live Load (LL)</b>		
Roof Live Load	20-psf	-
Floor Live Load (80-psf + 20-psf for Partitions)	-	100-psf

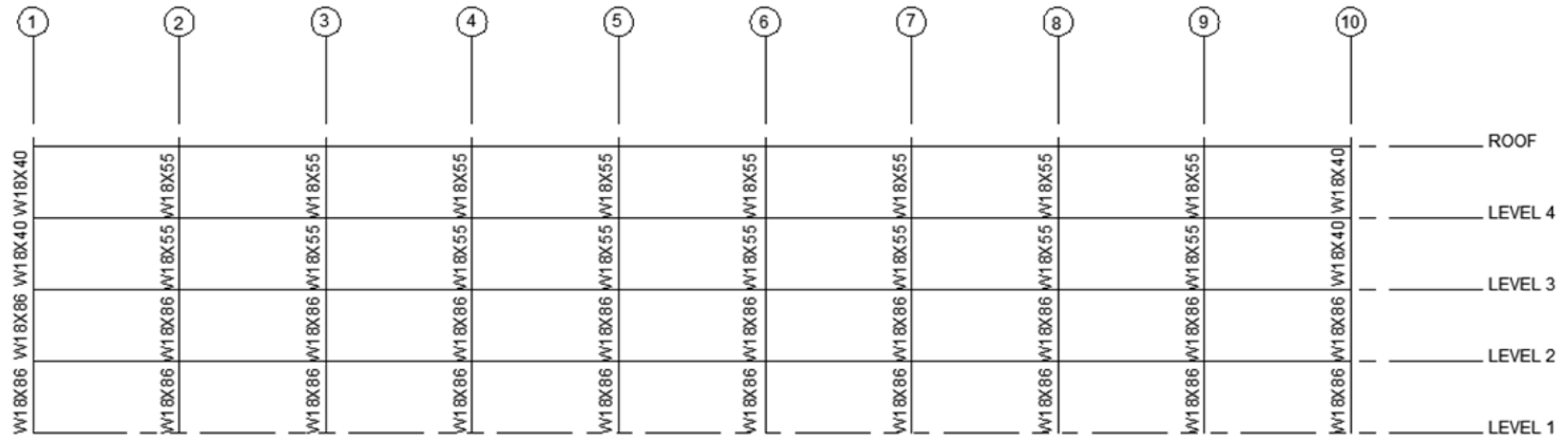




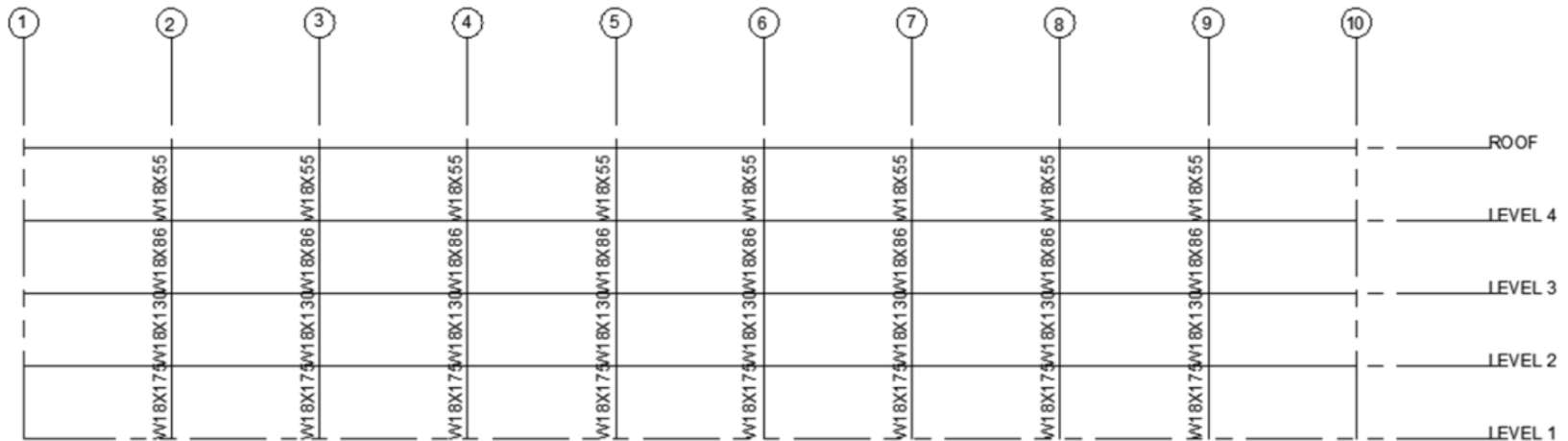
#### E2.1.4 MEMBER SIZES

Baseline preliminary member sizes resulting from design to meet the IBC 2006 [20] and loading identified in Section E2.1.3 are shown in Figure E2.3 through Figure E2.6. Gravity floor design is identical for Levels 2, 3 and 4 and perimeter moment frames vary up the height of the building for drift control.



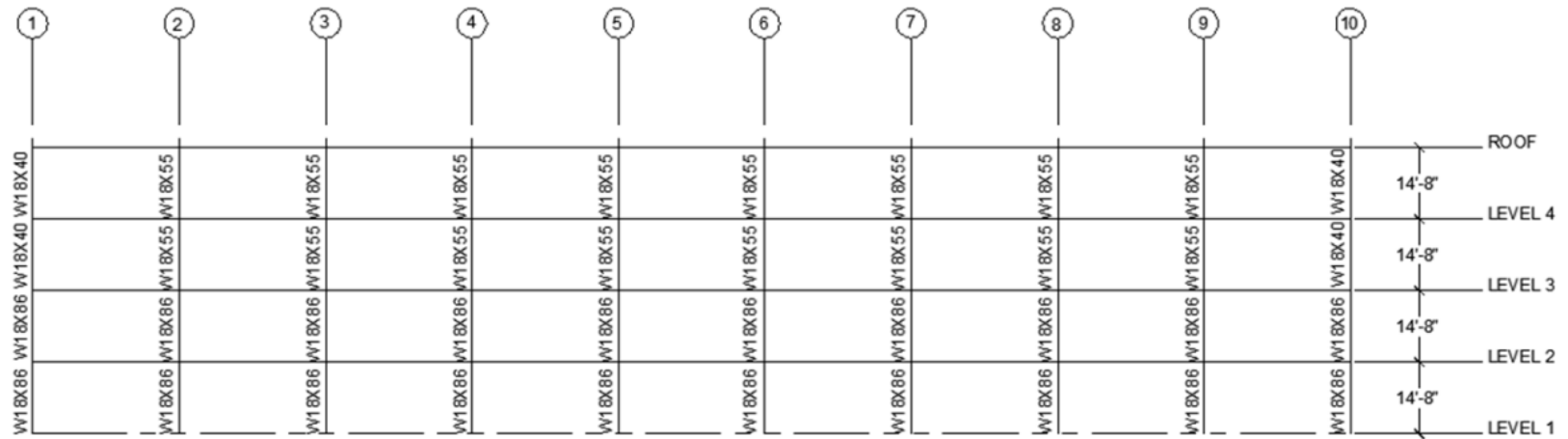


South Elevation – Gridline A

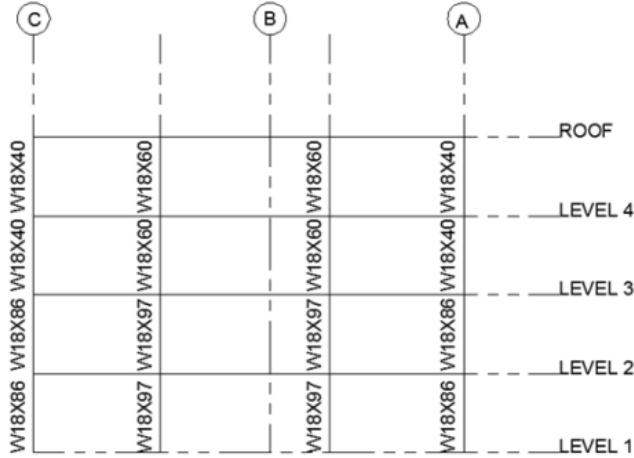


Interior Elevation – Gridline B

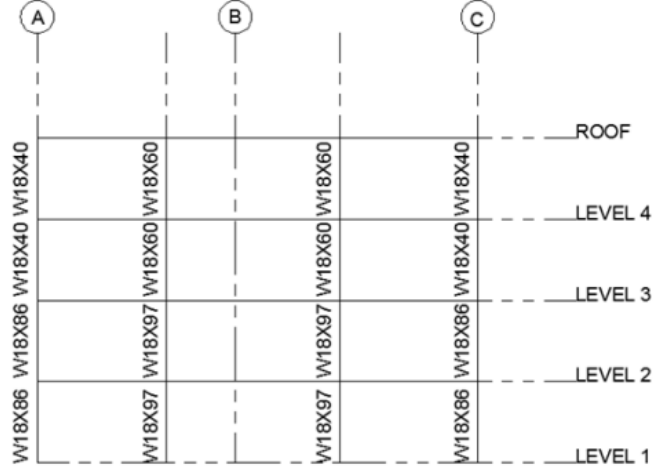
**Figure E2.3: Building Elevations (South & Interior)**



North Elevation – Gridline C

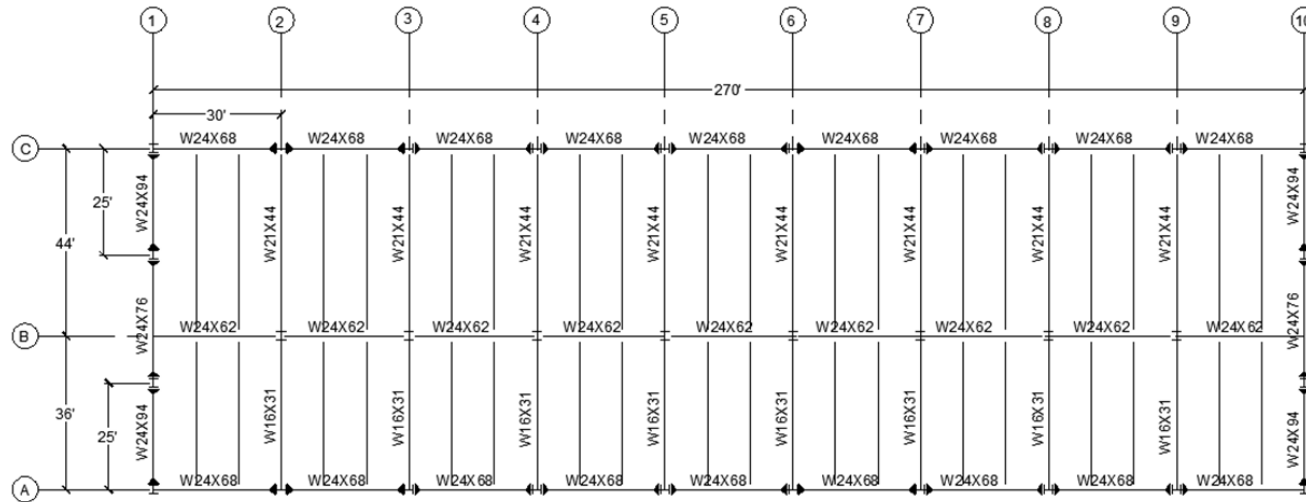


West Elevation – Gridline 1

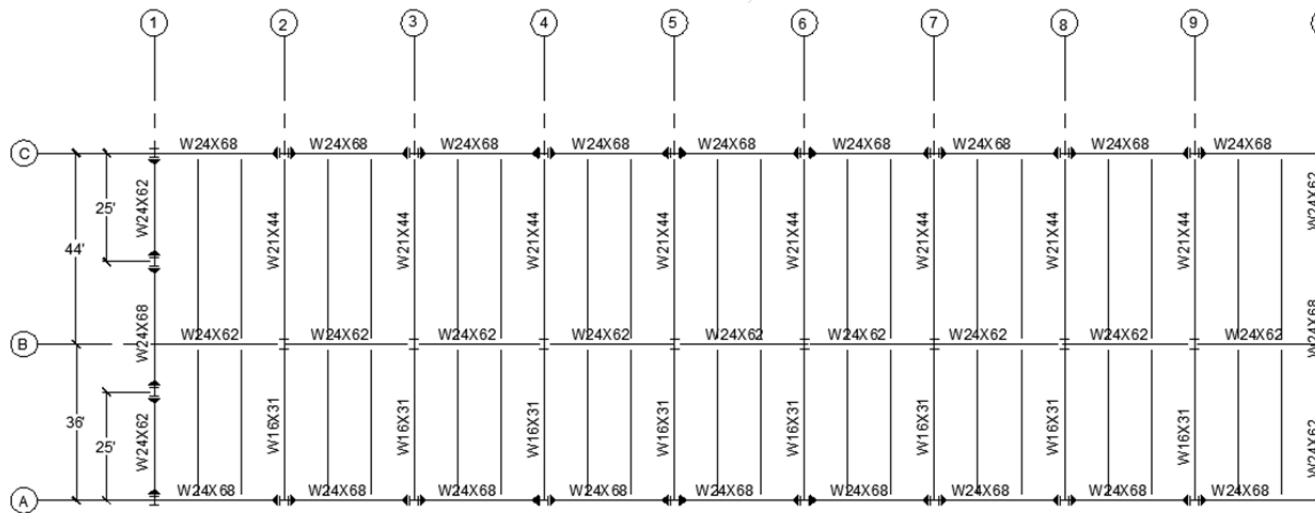


East Elevation – Gridline 10

**Figure E2.4: Building Elevations (North, West & East)**

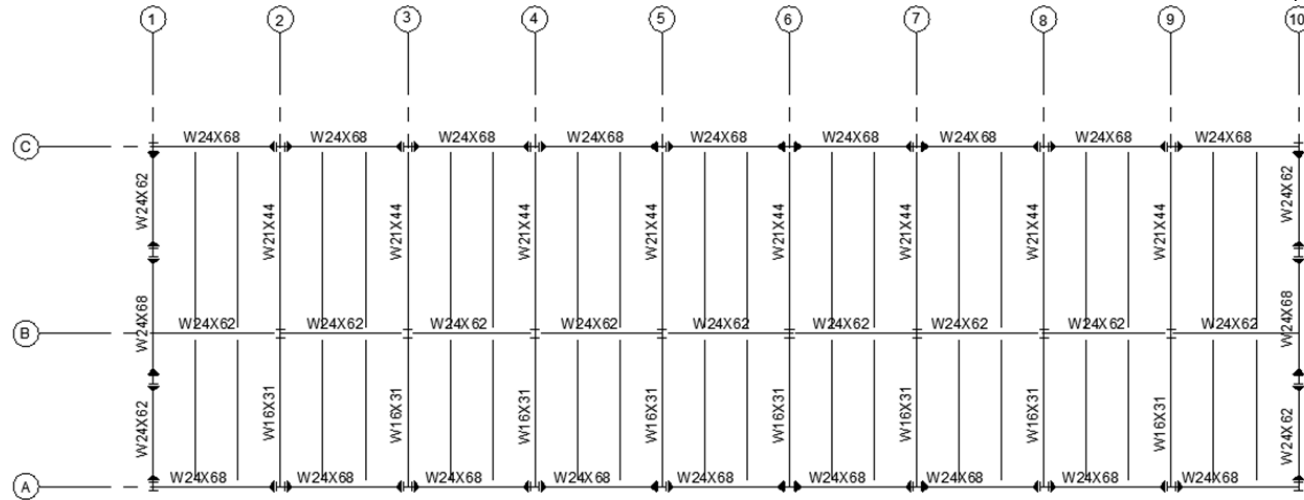


Level 2 Floor Plan

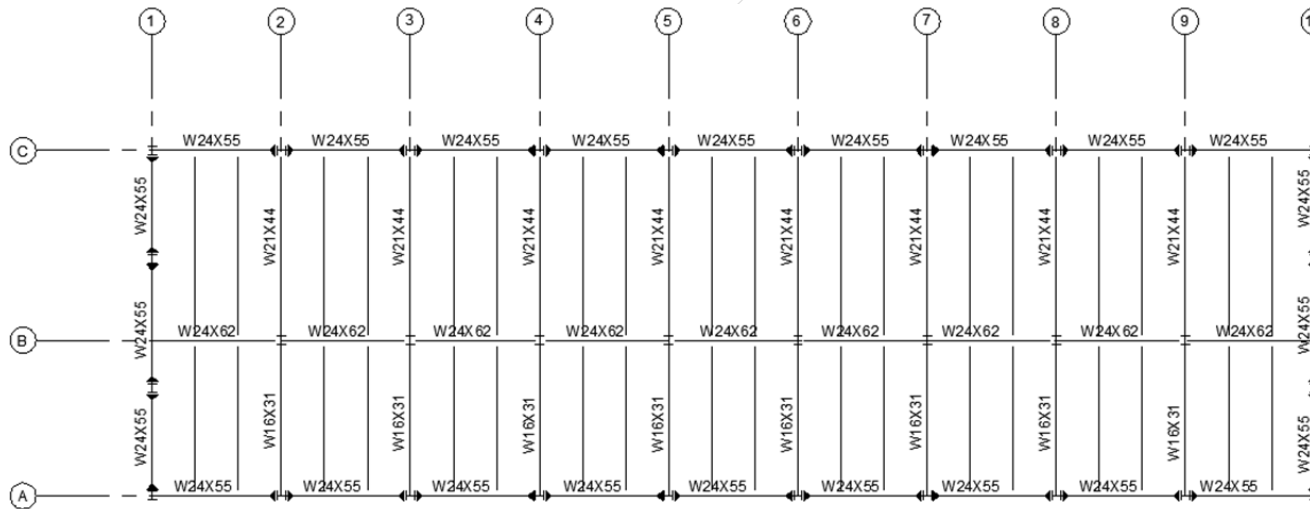


Level 3 Floor Plan

**Figure E2.5: Building Level 2 and 3 Floor Plans**



Level 4 Floor Plan



Roof Floor Plan

**Figure E2.6: Building Level 4 and Roof Plans**

## E3 LINEAR STATIC PROCEDURE

This section provides a step-by-step guide to the application of the Linear Static Procedure (LSP) for the design example building.

### E3.1 DCR AND IRREGULARITY CHECK

The first step in performing a LSP analysis is determining whether the structure triggers any of the irregularity limitations of Section 3.2.11.1. If the structure is determined as irregular, the designer must then evaluate the DCR limits of Section 3.2.11.1.2 in order to determine whether the LSP can be used or if an alternative method (i.e. Nonlinear Static or Nonlinear Dynamic) is required.

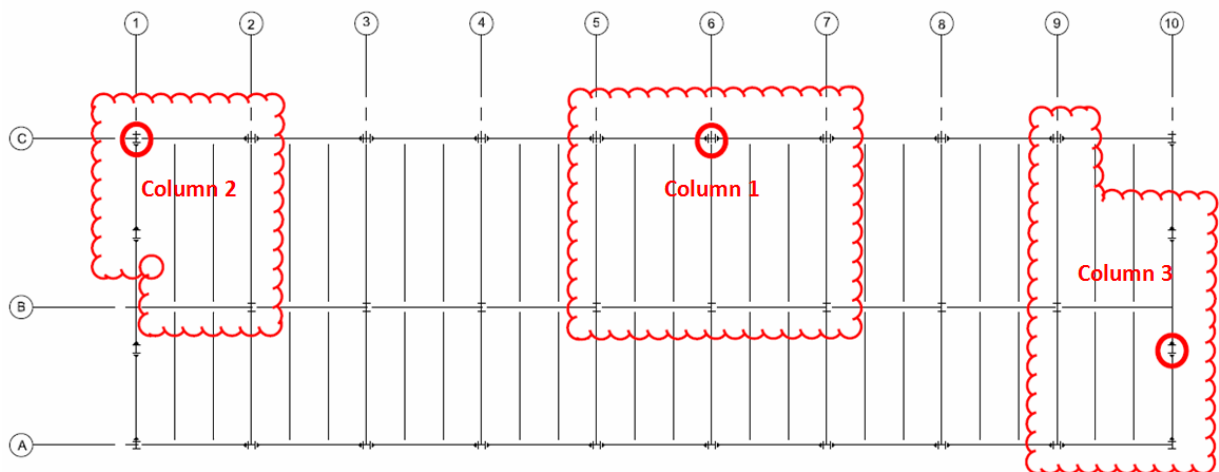
The baseline design does not trigger the irregularity limitations as: 1) it does not have any vertical discontinuities; 2) bay stiffness/strength does not vary in either direction at corner columns; and 3) all lateral-load resisting elements are parallel to the major orthogonal axes of the building. Therefore, the LSP can be used.

### E3.2 COLUMN REMOVAL LOCATIONS

Three representative column removal locations were considered in this analysis example, as shown in Figure E3.1:

- Removal 1 – Corner column condition.
- Removal 2 – Long side column condition.
- Removal 3 – Short side column condition.

In general, all components require evaluation for the acceptance criteria in these Guidelines; however for the purposes of this example, analysis results are only provided for the members in the bays adjacent to the column removal and at all floors above the column removal, as bubbled in red on Figure E3.1.



**Figure E3.1: Column Removal Locations**



### E3.3 ANALYTICAL MODELING

#### E3.3.1 PRIMARY AND SECONDARY ELEMENT CLASSIFICATION

Prior to developing the building model, elements need to be classified as either primary or secondary elements, in accordance with Section 3.2.4. Primary elements and their rotational stiffness/resistance are explicitly included in the model; however, the stiffness and resistance of those elements classified as secondary are not.

For the purposes of this example, only the perimeter moment frames are classified as primary. All gravity framing is classified as secondary. While beams at column gridlines are included in the model to distribute gravity loads to columns, their contribution to the stiffness and resistance of the structure is neglected and their end connections are modeled as pin-pin. Gravity framing is still required to be evaluated for the acceptance criteria of Section 3.2.10, however, using the less stringent criteria provided for secondary elements.

It should be noted that if the designer was to classify gravity framing as primary elements, their simple shear tab connections could be modeled as partially restrained moment connections, and their rotational stiffness and resistance included. Once classified as primary, however, gravity framing would need to be evaluated to meet the more stringent acceptance criteria of Section 3.2.10 accordingly.

#### E3.3.2 CLASSIFICATION OF DEFORMATION AND FORCE-CONTROLLED ACTIONS

In order to develop the appropriate load combinations and acceptance criteria for the analysis all elements need to be classified as either deformation or force-controlled. Classification of deformation and force-controlled actions is performed in accordance with Section 3.2.5 and guidance provided in ASCE 41 [10]. A summary of the classification of deformation and force-controlled actions for each element is provided in Table E23. Evaluation of whether columns are deformation or force controlled is a function of the axial load under the column removal scenario; therefore a check is required after completing the analysis.

**Table E23: Examples of Deformation-Controlled and Force-Controlled Actions from ASCE 41**

Component	Deformation-Controlled Action	Force- Controlled Action
Moment Frames <ul style="list-style-type: none"> <li>• Beams</li> <li>• Columns</li> <li>• Joints</li> </ul>	Moment (M) M, Axial Load (P) --	Shear (V) P, V V
Connections	M	V

For simplicity, the designer may consider developing two separate models due to different modeling requirements for loading and design strengths for deformation and force-controlled actions, as well as different acceptance criteria. A summary of the different modeling requirements for deformation and force-controlled actions is provided in Table E24. Additional discussion of these differences is provided in the applicable section below.

**Table E24: Model Requirements for Deformation and Force-Controlled Actions**

Design and/or Modeling Assumption	Deformation-Controlled	Force-Controlled
Design Strength	Expected ( $Q_{CE}$ )	Lower Bound ( $Q_{CL}$ )
Load Increase Factor	$0.9 m_{LIF} + 1.1$	2.0
Demand Modifier	m-factor	1.0





### E3.3.3 M-FACTORS

Each component within the structure is assigned an m-factor, or demand modifier. The demand-modifier can be considered as the allowable Demand-Capacity-Ratio and is evaluated as the force or deformation-controlled action divided by the design strength. The governing m-factor for each component is based on the smallest of the element or its connection.

An example calculation of m-factors for a typical beam, improved WUF connection, and column is provided below for Column Removal 1. Following the example, the m-factors for all the baseline design beams and columns (primary components) used in this example are listed in Table E25 and Table E26. It should be noted that the majority of columns for the baseline design are force-controlled, as shown in Table E26; however for the purpose of the example calculation, columns were assumed to be deformation-controlled in order to demonstrate how to calculate the corresponding deformation-controlled m-factor.

For simplicity, only those elements that are considered critical for each column removal scenario are shown.

#### E3.3.3.1 TYPICAL BEAM COMPONENT

The m-factor for beam components is determined in accordance with Table 9-4 of ASCE 41 [10] based on a Collapse Prevention performance level and a Primary component classification. The m-factor is a function of the section compactness, as represented by the flange width-to-thickness and web depth-to-thickness ratios. The following steps outline the general procedure for evaluating the appropriate m-factor:

- 1) Beam section properties are defined per AISC [20] steel manual for a W24x68:

$$\text{Width of Flange, } b_f = 8.97in \qquad \text{Thickness of Flange, } t_f = 0.585in$$

$$\text{Depth of Web, } h = 21.84in \qquad \text{Thickness of Web, } t_w = 0.42in$$

- 2) Expected strength is defined based on deformation controlled action (i.e. flexure) for A992 steel using Tables 9-2 & 9-3 of ASCE 41 [10] :

$$\text{Lower bound strength, } F_{yl} = 50ksi \qquad (\text{Table 9-2 - ASCE 41 [10]})$$

$$\text{Factor to translate to Expected Strength} \qquad (\text{Table 9-3 - ASCE 41 [10]}) \\ = 1.10$$

$$\text{Expected strength, } F_{ye} = F_{yl} \times 1.10 = 55ksi$$

- 3) The component/action is evaluated in accordance with the "Beam-Flexure" section of Table 9-4 of ASCE 41 [10]:

$$\frac{b_f}{2t_f} = \frac{8.97in}{2 \times 0.585in} = 7.67 \qquad \frac{h}{t_w} = \frac{21.84in}{0.42in} = 52$$

4) The component/action is compared with limits a and b :

$$\begin{array}{ll}
 a & \frac{b_f}{2t_f} \leq \frac{52}{\sqrt{F_{ye}}} = 7.01 & \frac{h}{t_w} \leq \frac{418}{\sqrt{F_{ye}}} = 56.4 \\
 b & \frac{b_f}{2t_f} \leq \frac{65}{\sqrt{F_{ye}}} = 8.76 & \frac{h}{t_w} \leq \frac{640}{\sqrt{F_{ye}}} = 86.3
 \end{array}$$

5) The governing m-factor is evaluated using linear extrapolation between a and b for both the flange and web width-to-thickness ratios.

$$m = m_a - \frac{(m_a - m_b)}{\left(\frac{65}{\sqrt{F_{ye}}} - \frac{52}{\sqrt{F_{ye}}}\right)} \left(\frac{b_f}{2t_f} - \frac{52}{\sqrt{F_{ye}}}\right) \quad \frac{h}{t_w} \leq 56.4 \therefore m = 8$$

$$m = 8 - \frac{(8 - 3)}{(8.76 - 7.01)} (7.67 - 7.01) = 6.15$$

The flange width-to-thickness ratio governs; therefore the m-factor for the steel beam component is taken as 6.15

### E3.3.3.2 IMPROVED WUF CONNECTION

The m-factor for improved WUF connections is determined in accordance with Table 10 of this document based on a primary component classification and is a function of the beam depth.

$$\begin{aligned}
 m &= 3.1 - 0.032d \\
 \text{where } d &= 23.7in \\
 m &= 3.1 - 0.032 \times 23.7 = 2.34
 \end{aligned}$$

### E3.3.3.3 COLUMN

The m-factor for column components is determined in accordance with Table 9-4 of ASCE 41 [10] based on a Collapse Prevention performance level and a Primary component classification. The m-factor is a function of the section compactness, as represented by the flange width-to-thickness and web depth-to-thickness ratios and its axial load demand-capacity ratio (DCR). The following steps outline the general procedure for evaluating the appropriate m-factor:

1) For preliminary evaluation of column m-factors it is assumed that the column is deformation-controlled and that the following equation is met:

$$0.2 \leq \frac{P}{P_{CL}} \leq 0.5$$

where  $P$  = Axial force in the column due to the column removal scenario

$P_{CL}$  = Lower-bound axial strength of the column

This assumption needs to be verified after the column removal analysis is performed.

- 2) The column section properties are defined per AISC [20] steel manual for a W18x86 (Gridline A:1 at Level 1):

$$\text{Width of Flange, } b_f = 11.1\text{in} \qquad \text{Thickness of Flange, } t_f = 0.770\text{in}$$

$$\text{Depth of Web, } h = 16.03\text{in} \qquad \text{Thickness of Web, } t_w = 0.48\text{in}$$

- 3) Define lower bound strength based on a force controlled action (i.e. axial compression) for A992 steel using Tables 9-2 of ASCE 41 [10] :

$$\text{Lower bound strength, } F_{yl} = 50\text{ksi} \qquad (\text{Table 9-2 - ASCE 41 [10]})$$

$$\text{Factor to translate to Expected Strength} \qquad (\text{Table 9-3 - ASCE 41 [10]}) \\ = 1.10$$

$$\text{Expected strength, } F_{ye} = F_{yl} \times 1.10 = 55\text{ksi}$$

- 4) Evaluate component/action in accordance with the "Column-Flexure" section of Table 9-4 of ASCE 41 [10]:

$$\frac{b_f}{2t_f} = \frac{11.1\text{in}}{2 \times 0.770\text{in}} = 7.21$$

$$\frac{h}{t_w} = \frac{16.03\text{in}}{0.48\text{in}} = 33.4$$

- 5) Compare with limits a and b :

$$a \qquad \frac{b_f}{2t_f} \leq \frac{52}{\sqrt{F_{ye}}} = 7.01$$

$$\frac{h}{t_w} \leq \frac{260}{\sqrt{F_{ye}}} = 35$$

$$b \qquad \frac{b_f}{2t_f} \leq \frac{65}{\sqrt{F_{ye}}} = 8.76$$

$$\frac{h}{t_w} \leq \frac{400}{\sqrt{F_{ye}}} = 54$$

- 6) Determine governing m-factors for a primary element using Collapse Prevention. For preliminary evaluation of m-factors assumed that  $P/P_{CL} = 0.5$ .

$$a \qquad m = 12 \times \left(1 - \frac{5}{3} \frac{P}{P_{CL}}\right) = 2.0$$

$$b \qquad m = 1.5$$

- 7) The governing m-factor is evaluated using linear extrapolation between a and b for both the flange and web width-to-thickness ratios.

$$m = m_a - \frac{(m_a - m_b)}{\left(\frac{65}{\sqrt{F_{ye}}} - \frac{52}{\sqrt{F_{ye}}}\right)} \left(\frac{b_f}{2t_f} - \frac{52}{\sqrt{F_{ye}}}\right) \qquad \frac{h}{t_w} \leq 35 \therefore m = 2.0$$



$$m = 2.0 - \frac{(2.0 - 1.5)}{(8.76 - 7.01)}(7.21 - 7.01) = 1.94$$

The flange width-to-thickness ratio governs; therefore the m-factor for the column component is taken as 1.94.

**Table E25: Beam Component m-factors for Deformation Controlled Actions of Primary Components**

Column Removal	Beam Location (Level)	Beam Size	Component m-factors	Connection m-factors (3.1-0.032d)
1	2, 3, 4	W24x68	6.15	2.34
	Roof	W24x55	8.00	2.34
	2, 3, 4, Roof	W21x44 <sup>1</sup>	11.05	9.13
	2, 3, 4, Roof	W24x62 <sup>1</sup>	12.00	7.99
2	2	W24x76	12.00	9.63
	2	W24x94	12.00	9.79
	2, 3, 4	W24x68	9.04	9.55
	3, 4, Roof	W24x62	12.00	9.55
	Roof	W24x55	12.00	9.51
	2, 3, 4, Roof	W21x44 <sup>1</sup>	11.05	9.13
3	2	W24x94	8.00	2.32
	2, 3, 4, Roof	W24x62	8.00	2.34
	Roof	W24x55	8.00	2.34
	2	W24x76	8.00	2.34
	2, 3, 4	W24x68	6.15	2.34
	2, 3, 4, Roof	W16x31 <sup>1</sup>	12.00	10.85
	2, 3, 4, Roof	W21x44 <sup>1</sup>	11.05	9.13
1. Secondary components				

**Table E26: Column Component m-factors for Deformation & Force Controlled Actions of Primary Components**

Column Removal	Column Location (Level)	Column Size	P/P <sub>CL</sub>	Governing m-factors
1	1	W18x86	1.45	Force-Controlled
	2	W18x86	1.05	Force-Controlled
	3	W18x55	0.94	Force-Controlled
	4	W18x55	0.25	5.20
	1	W18x175	0.92	Force-Controlled
	2	W18x130	0.86	Force-Controlled
	3	W18x86	0.72	Force-Controlled
	4	W18x55	0.23	5.54
	1	W18x86	0.00	7.36
	2	W18x86	0.05	7.36
	3	W18x55	0.17	7.82
	4	W18x55	0.29	4.68
2	1	W18x86	0.63	Force-Controlled



Column Removal	Column Location (Level)	Column Size	P/P <sub>CL</sub>	Governing m-factors
	2	W18x86	0.44	4.52
	3	W18x55	0.39	5.02
	4	W18x55	0.09	11.73
	1	W18x86	0.19	11.03
	2	W18x86	0.13	11.03
	3	W18x55	0.12	11.73
	4	W18x55	0.03	11.73
	1	W18x97	0.23	10.96
	2	W18x97	0.16	12.00
	3	W18x60	0.15	12.00
	4	W18x60	0.04	12.00
3	1	W18x86	1.00	Force-Controlled
	2	W18x86	0.69	Force-Controlled
	3	W18x55	0.61	Force-Controlled
	4	W18x55	0.14	7.82
	1	W18x97	1.09	Force-Controlled
	2	W18x97	0.74	Force-Controlled
	3	W18x60	0.71	Force-Controlled
	4	W18x60	0.25	5.86
	1	W18x86	0.73	Force-Controlled
	2	W18x86	0.48	2.22
	3	W18x40	0.59	Force-Controlled
	4	W18x40	0.21	2.51
	1	W18x86	0.83	Force-Controlled
	2	W18x86	0.58	Force-Controlled
	3	W18x55	0.51	Force-Controlled
	4	W18x55	0.12	7.82
	1	W18x175	0.74	Force-Controlled
	2	W18x130	0.69	Force-Controlled
	3	W18x86	0.58	Force-Controlled
	4	W18x55	0.18	7.82
	1	W18x97	0.00	8.00
2	W18x97	0.05	8.00	
3	W18x60	0.03	8.00	
4	W18x60	0.08	8.00	

### E3.3.4 LOAD INCREASE FACTORS

Section 3.2.11.5 provides load increase factors (Table 4) for areas of framing immediately surrounding the column removal. For steel frame structures, the load increase factor for forced-controlled actions is



2.0. For deformation-controlled actions the load increase factor is a function of the smallest m-factor of any primary beam, girder or column that is directly above the removal location. The load increase factors for this example are shown in Table E27 for each column removal.

**Table E27: Load Increase Factors ( $\Omega$ )**

Column Removal	Deformation-Controlled		Force-Controlled
	$m_{LIF}$ (smallest m-factor)	$\Omega_{LD} = 0.9 m_{LIF} + 1.1$	$\Omega_{LF}$
1	2.34	3.206	2
2	2.32	3.188	2
3	2.32	3.188	2

### E3.3.5 LOAD COMBINATIONS

Section 3.2.11.4 provides the required load combinations for use in a LSP. Three different load combinations are provided for use in the analysis, depending on whether deformation or force-controlled actions are used and the location of the elements being loaded as it relates to the column being removed.

For those bays immediately adjacent to the removed element and at all floors above the removed element the load combination includes a load increase factor, discussed in Section E3.3.4. For deformation-controlled actions:

$$G_{LD} = \Omega_{LD} [1.2 D + (0.5 L \text{ or } 0.2 S)] \quad \text{Equation 3.10}$$

where  $G_{LD}$  = Increased gravity loads for deformation-controlled actions for Linear Static analysis

$D$  = Dead load including façade loads ( $\text{lb/ft}^2$  or  $\text{kN/m}^2$ )

$L$  = Live load including live load reduction not to exceed  $50\text{-lb/ft}^2$  or  $244\text{-kN/m}^2$

$S$  = Snow load ( $\text{lb/ft}^2$  or  $\text{kN/m}^2$ )

$\Omega_{LD}$  = Load increase factor for calculating deformation- controlled actions

For force-controlled actions:

$$G_{LF} = \Omega_{LF} [1.2 D + (0.5 L \text{ or } 0.2 S)] \quad \text{Equation 3.10}$$

where  $G_{LF}$  = Increased gravity loads for force-controlled actions for Linear Static analysis

For those bays not immediately adjacent to the removed element the load combination is the same for both deformation and force-controlled actions:

$$G = 1.2 D + (0.5 L \text{ or } 0.2 S)$$

Equation 3.10

where  $G$  = Gravity loads

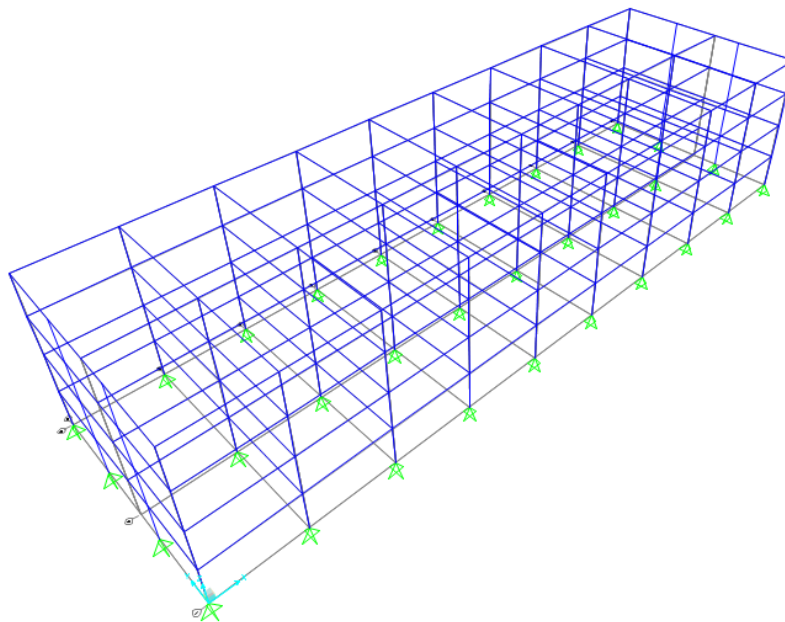
It should be noted that all load combinations include a limit of 50-lb/ft<sup>2</sup> or 244-kN/m<sup>2</sup> for the unfactored live loads used in the analysis. For this example, this would result in a 50% reduction of the baseline design live load of 100-psf.

## E4 ALTERNATIVE PATH ANALYSIS

This section presents the analysis steps performed as part of the Linear Static Procedure and the design requirements and modeling assumptions described in the previous sections. The software used and screenshots depicted are from SAP2000 V.15.1.0. For the purpose of this example, redistribution of loads upon column removal was performed manually; however, the designer may also use features such as SAP's "Staged Construction" to ensure proper redistribution.

### E4.1 DEVELOP PRELIMINARY MODEL

The model developed in SAP2000 is shown in Figure E4.1. As discussed in Section E3.3.1, the model includes the perimeter moment frames and gravity framing on column lines only. For simplicity, two separate models were to be developed for deformation and force-controlled actions. However, if the designer is not utilizing the "design check" feature of the analysis software and design strengths and resulting DCR's are calculated manually, one model with multiple load cases may be used.



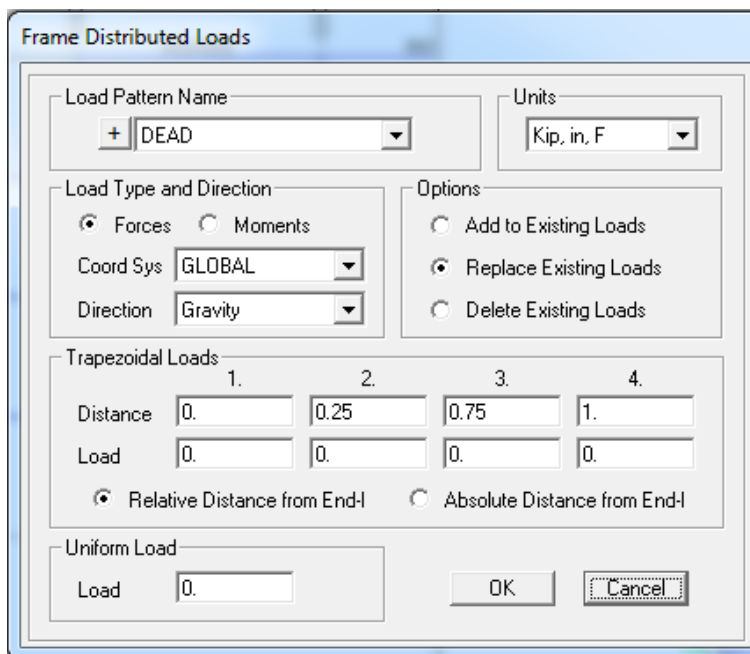
**Figure E4.1: Isometric View of SAP Model**

## E4.2 DEFINE LOAD CASES AND ASSIGN LOADS.

The applied load on each member is defined as a distributed line load based on the appropriate tributary width and load increase factor using load patterns, as shown in Figure E4.2. Five load patterns were used in this example for each column removal and action: DEAD (dead), Clad (cladding), SDL (superimposed dead load), LL (floor live load), and LR (roof live load).

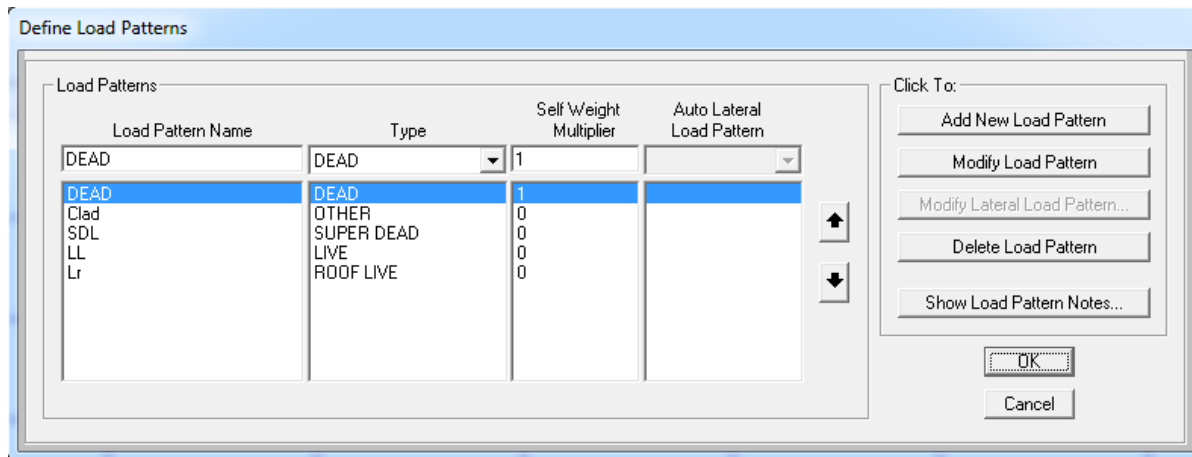
Load patterns can be adjusted to include a self-weight multiplier, which when set to 1.0 includes the self-weight of the member in the specified load pattern. For this example, a self-weight multiplier is applied to the DEAD (dead load) load pattern as shown in the screenshot in Figure E4.3. A self-weight modifier should only be applied to one load pattern so that it is only included in the analysis once.

Load patterns are combined using the load combinations described in Section E3.3.5. SAP2000 uses load cases to combine the load patterns in terms of scale factors as shown in Figure E4.4. When assigning load cases, the designer must also define the type of analysis to be performed. While this is a linear static procedure, the nonlinear analysis check-box is selected to allow to evaluation of P-Delta effects, which is a non-linear behavior.

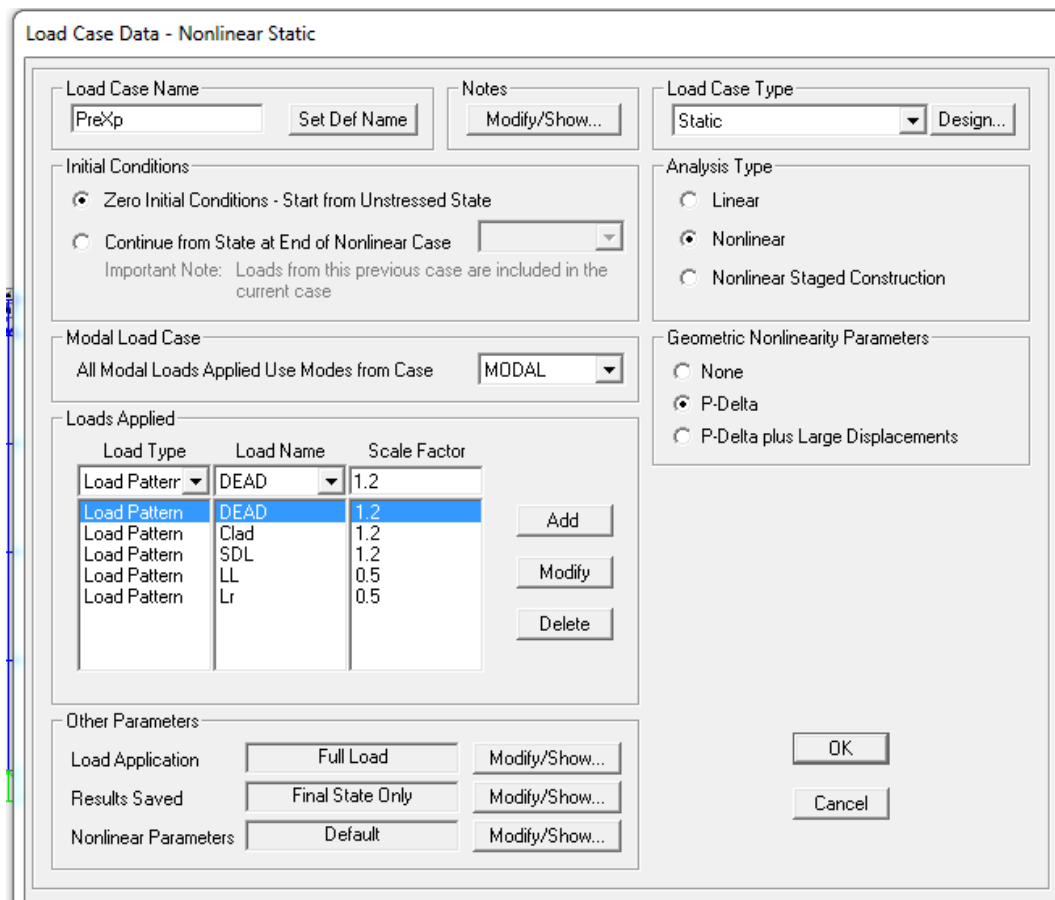


**Figure E4.2: Screenshot from SAP2000 for Load Pattern Assignment**





**Figure E4.3: Summary of Load Pattern Assignments**



**Figure E4.4: Load Case Input in SAP**

### E4.3 RUN ANALYSIS AND COMPARE TO ACCEPTANCE CRITERIA

It is important to check that both stages (before and after column removal) of every analysis case converge. If the analysis does not converge there is a problem with the model that must be fixed prior to proceeding with the analysis.

After each analysis case converges, the demand-capacity-ratio (DCR) of each component is evaluated ( $Q_{UD}/\Phi Q_{CE}$  or  $Q_{UF}/\Phi Q_{CL}$ ) and compared to the defined acceptance criteria. For deformation-controlled elements, the DCR is compared to the governing m-factor for the element and its connections. For force-controlled elements the DCR must be less than 1.0.

To verify the assumption of deformation-controlled actions for columns, the deformation-controlled model is reviewed to determine the axial load ratio ( $P/P_{CL}$ ) for each removal scenario. In accordance with ASCE 41 [10], any column with an axial load ratio greater than or equal to 0.5 must be reclassified as force-controlled and reevaluated under the force-controlled modeling assumptions.

Analysis results for the performance of the baseline design under each column removal are shown in Figure E4.5 through Figure E4.12. Resulting DCR's of each element are shown directly below the section size. Values in red indicate that the acceptance criterion is not met for that particular section and upgrade is required. Values in blue indicate that the acceptance criterion is met by the current member size.

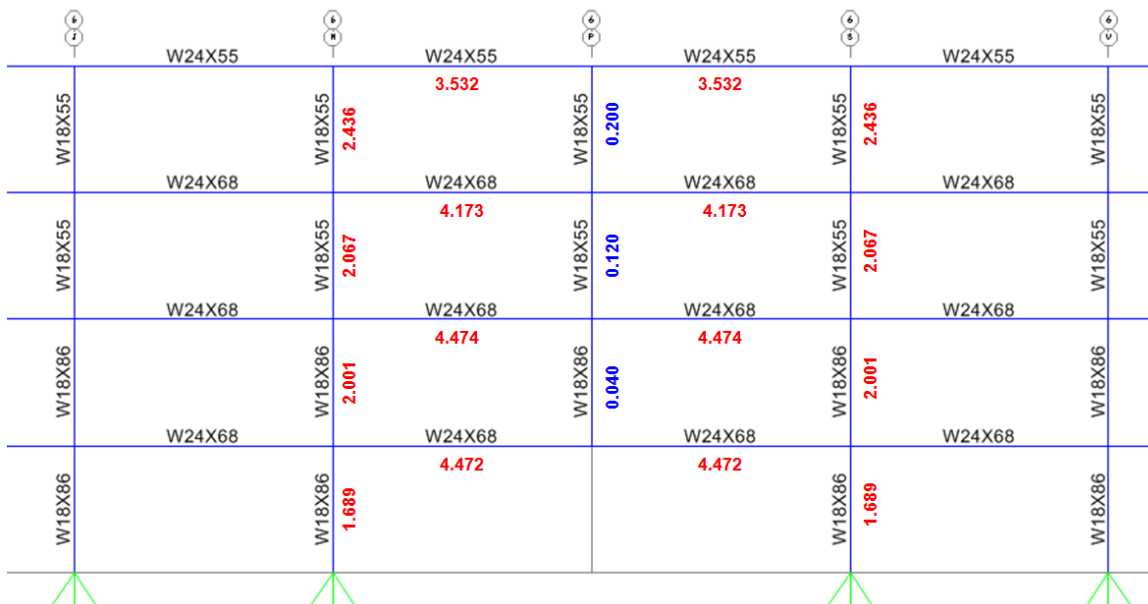


Figure E4.5: Column Removal 1 Original Design along Gridline C

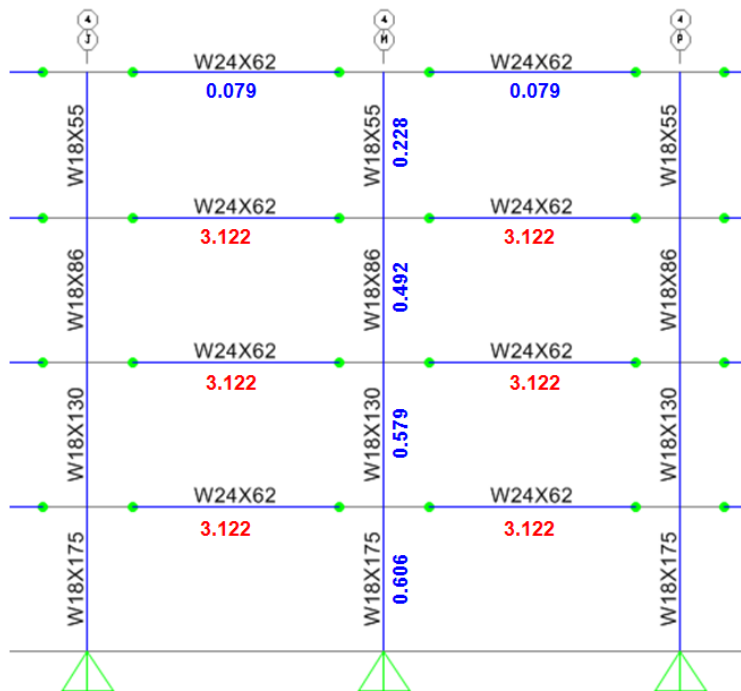


Figure E4.6: Column Removal 1 Original Design along Gridline B

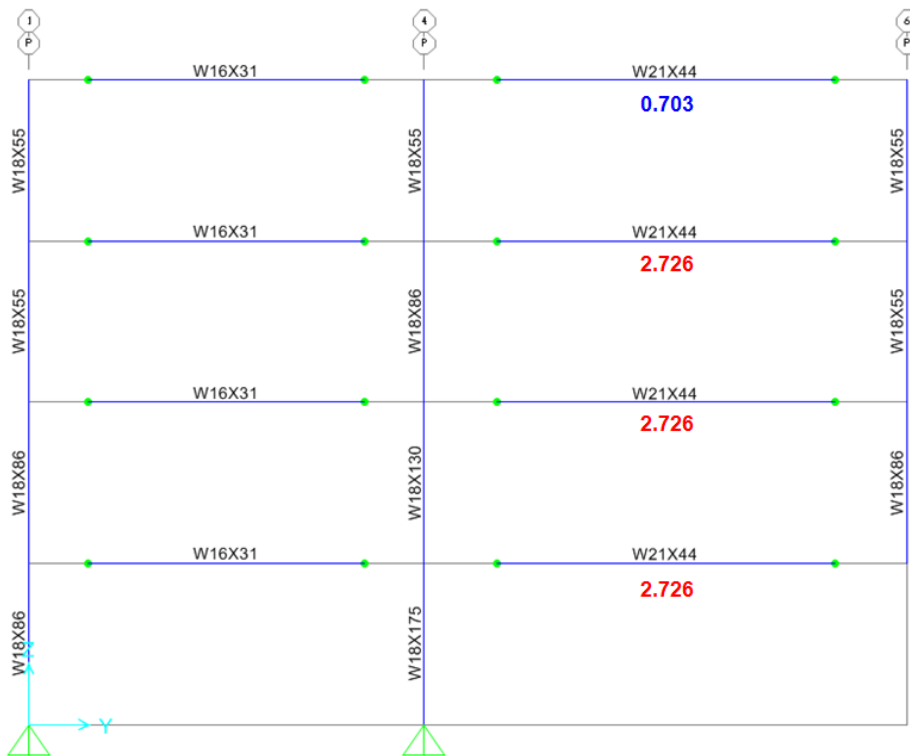
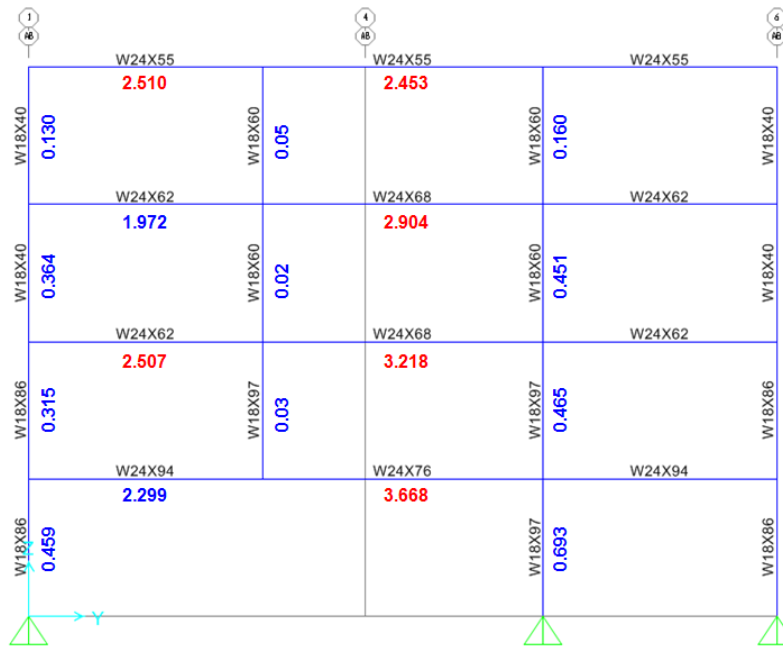
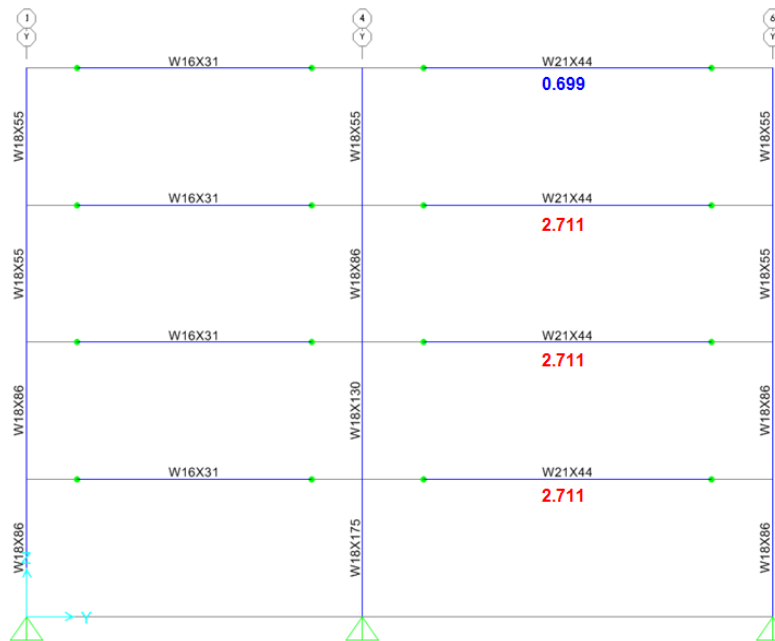


Figure E4.7: Column Removal 1 Original Design along Gridline 6



**Figure E4.8: Column Removal 3 Original Design along Gridline 10**



**Figure E4.9: Column Removal 3 Original Design along Gridline 9**

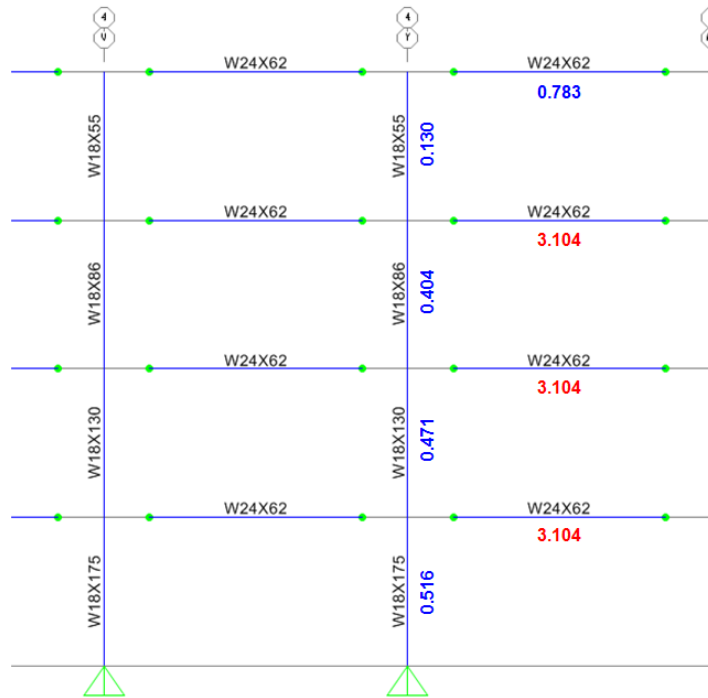


Figure E4.10: Column Removal 3 Original Design along Gridline B

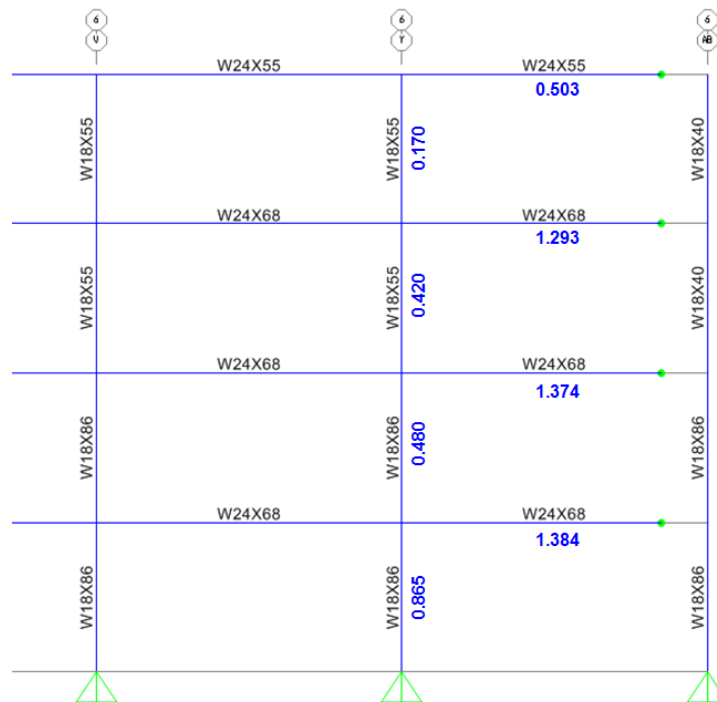
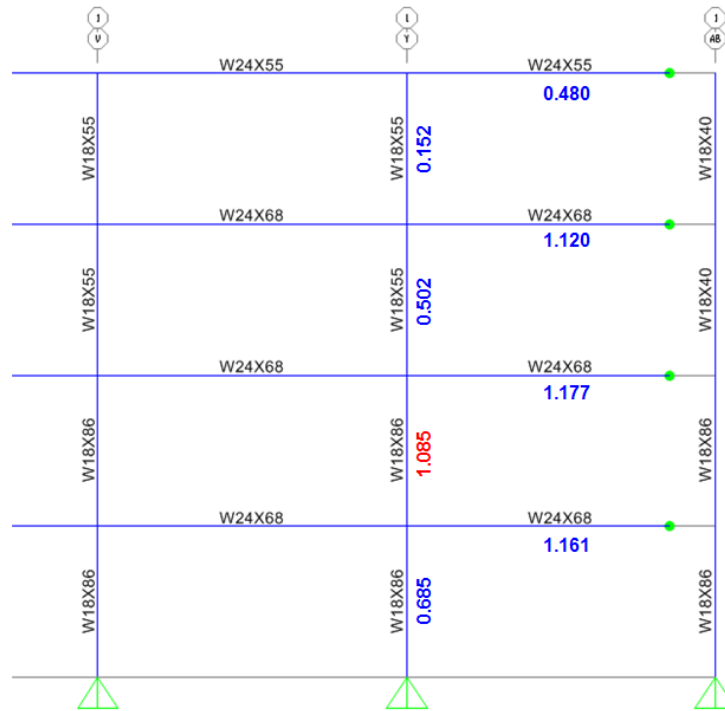


Figure E4.11: Column Removal 3 Original Design along Gridline C



**Figure E4.12: Column Removal 3 Original Design along Gridline A**

As shown in the previous figures, elements surrounding column removal 1 and 3 require redesign to meet the acceptance criteria. The preliminary designs of elements surrounding column removal 2 meet the acceptance criteria for Collapse Prevention and therefore do not require redesign.

As the members are redesigned, the m-factors must be adjusted accordingly for the redesigned members. The adjusted m-factors for the redesigned members are shown in Table E28 and Table E29. The analysis results for the redesigned members are shown in Figure E4.13 through Figure E4.20

**Table E28: Re-designed beam m-factors**

Column Removal	Beam Location	Beam Size	Governing m-factors	Connection m-factors
1	2,3	W24x131	8.00	2.32
	4	W24x117	6.52	2.32
	Roof	W24x68	6.15	2.34
3	2,3	W24x94	8.00	2.32
	2,3,4	W24x68	6.15	2.34
	4,Roof	W24x62	8.00	2.34
	2	W24x117	6.52	2.32
	2,3,4	W24x84	8.00	2.33
	Roof	W24x55	8.00	2.34
	2,3,4	W16x40	8.00	2.59
	Roof	W16x31	8.00	2.59



**Table E29: Redesigned Column m-factors**

Column Removal	Level	Column Size	P/PCL	Governing m-factors
1	1	W18x175	0.47	2.58
	2	W18x119	0.47	2.59
	3	W18x106	0.29	6.24
	4	W18x106	0.06	8.00
	1	W18x175	0.61	Force-Controlled
	2	W18x130	0.57	Force-Controlled
	3	W18x86	0.49	2.09
	4	W18x55	0.19	7.82
	1	W18x86	0.00	7.36
	2	W18x86	0.04	7.36
	3	W18x55	0.12	7.82
	4	W18x55	0.20	7.82
3	1	W18x86	1.00	Force-Controlled
	2	W18x86	0.69	Force-Controlled
	3	W18x55	0.61	Force-Controlled
	4	W18x55	0.14	7.82
	1	W18x97	1.09	Force-Controlled
	2	W18x97	0.74	Force-Controlled
	3	W18x60	0.71	Force-Controlled
	4	W18x60	0.25	5.86
	1	W18x86	0.73	Force-Controlled
	2	W18x86	0.48	2.22
	3	W18x40	0.59	Force-Controlled
	4	W18x40	0.21	2.51
	1	W18x97	0.74	Force-Controlled
	2	W18x97	0.51	Force-Controlled
	3	W18x55	0.51	Force-Controlled
	4	W18x55	0.12	7.82
	1	W18x175	0.74	Force-Controlled
	2	W18x130	0.69	Force-Controlled
	3	W18x86	0.58	Force-Controlled
	4	W18x55	0.18	7.82
	1	W18x97	0.00	8.00
	2	W18x97	0.05	8.00
	3	W18x60	0.03	8.00
	4	W18x60	0.08	8.00

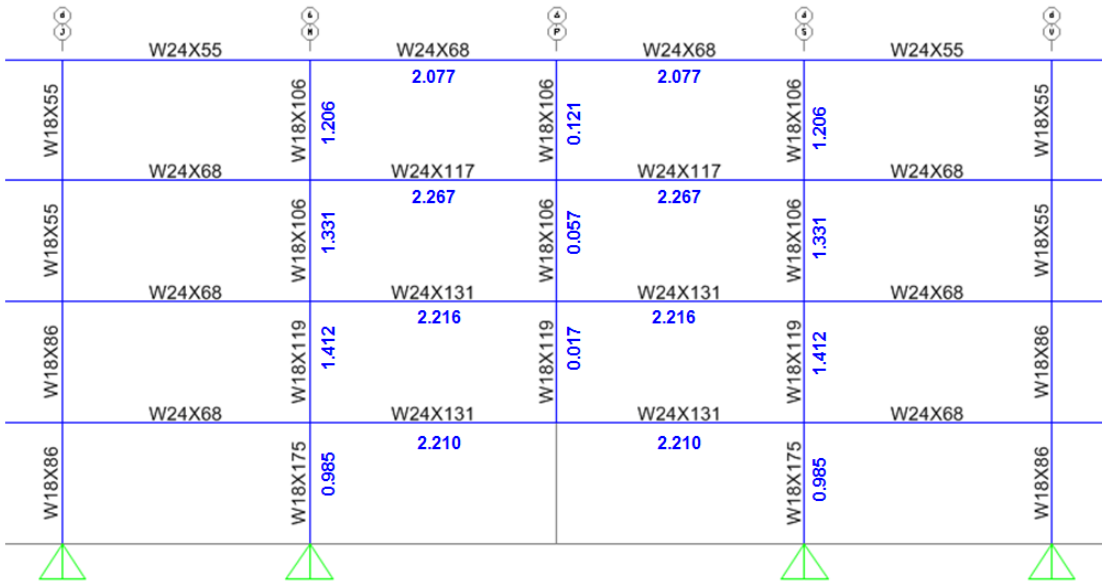


Figure E4.13: Column Removal 1 Upgraded Design along Gridline C

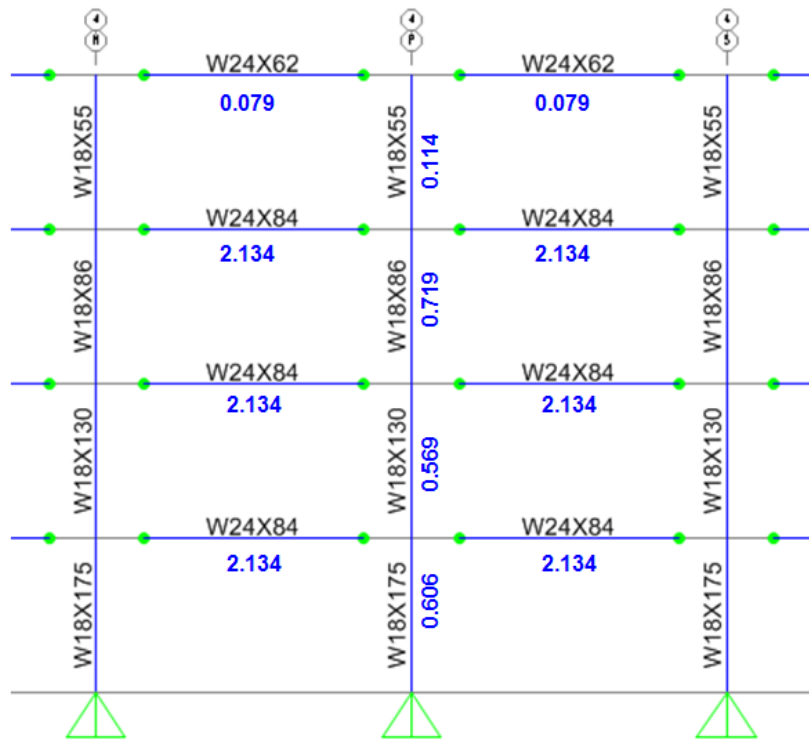


Figure E4.14: Column Removal 1 Upgraded Design along Gridline B



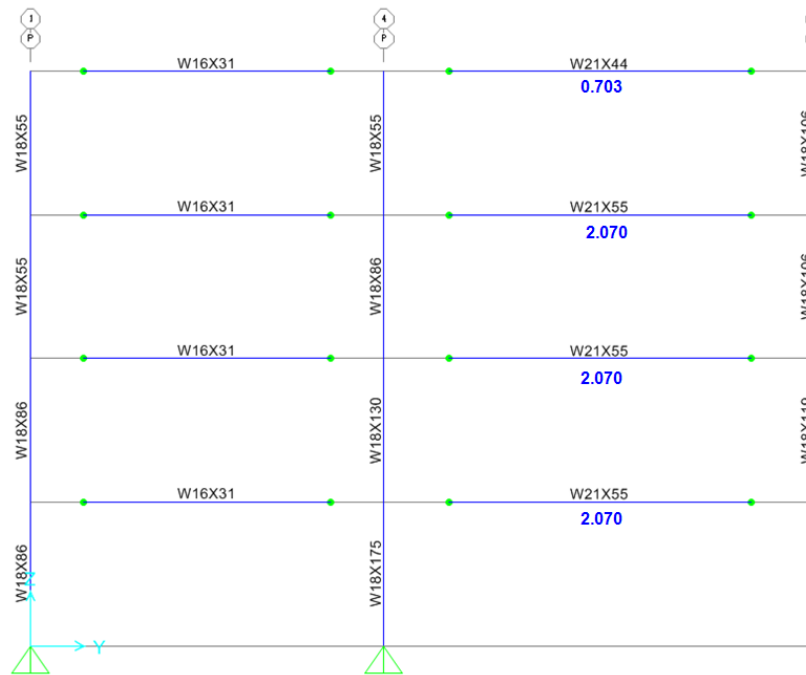


Figure E4.15: Column Removal 1 Upgraded Design along Gridline 6

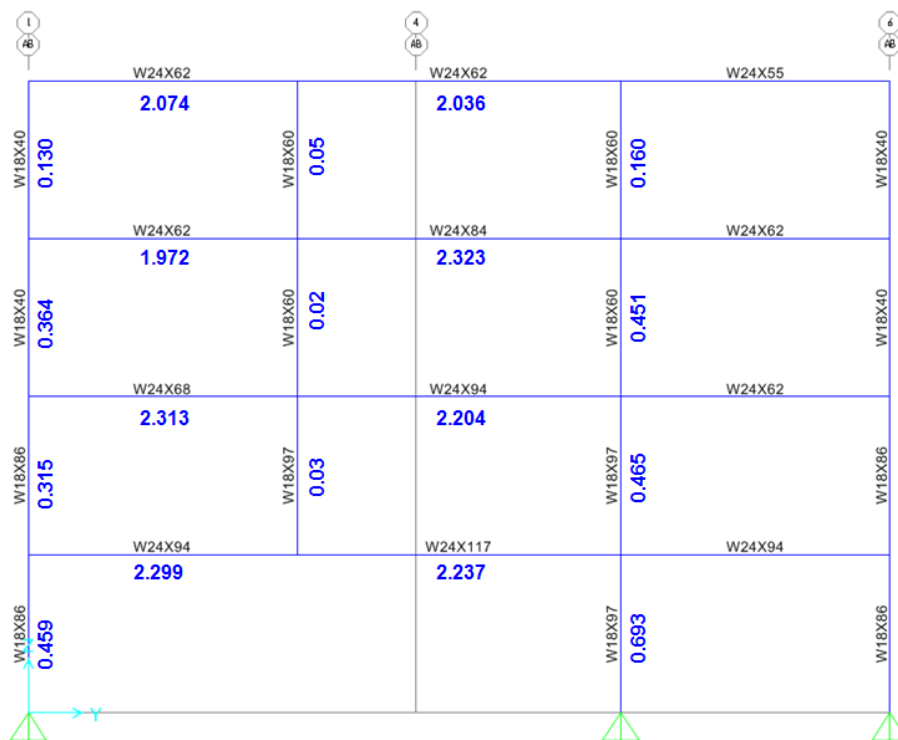
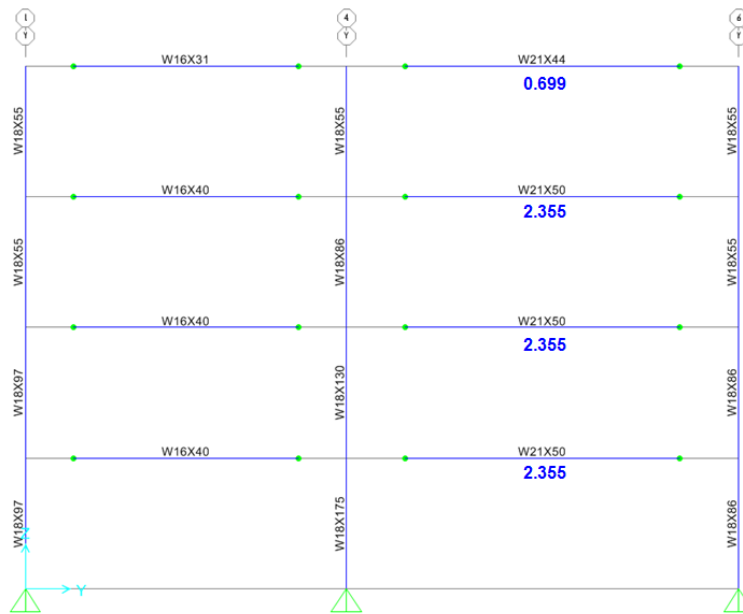
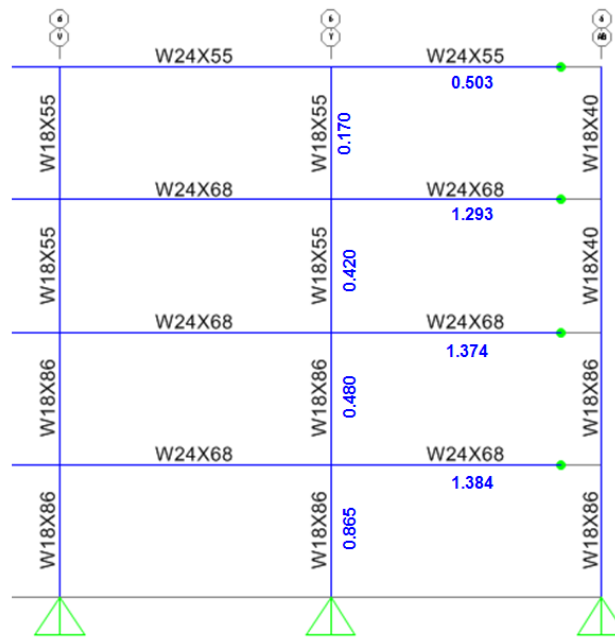


Figure E4.16: Column Removal 3 Upgraded Design along Gridline 10



**Figure E4.17: Column Removal 3 Upgraded Design along Gridline 9**



**Figure E4.18: Column Removal 3 Upgraded Design along Gridline C**

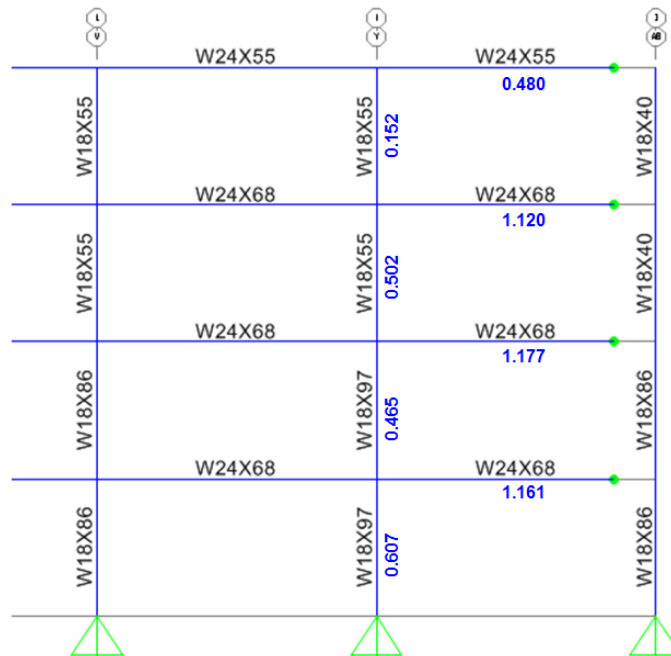


Figure E4.19: Column Removal 3 Upgraded Design along Gridline A

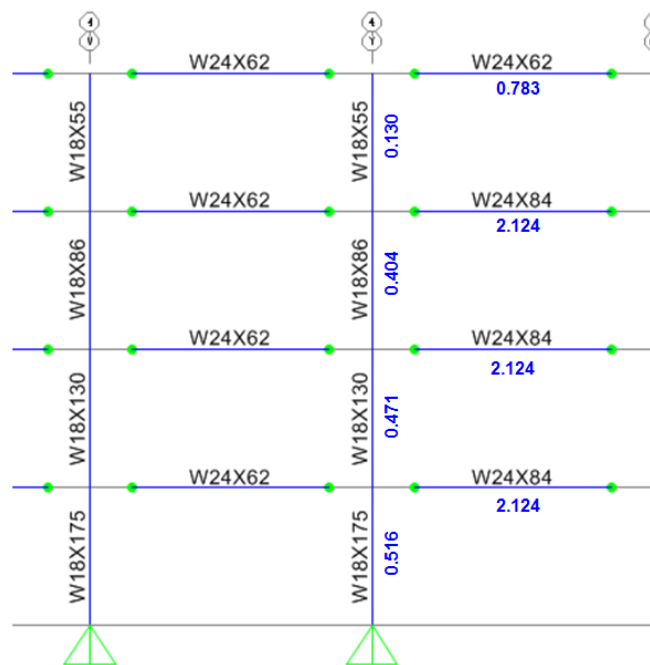


Figure E4.20: Column Removal 3 Upgraded Design along Gridline B



### E4.3.1 SECONDARY COMPONENT CHECKS

After verifying that all primary members satisfy the force- and deformation-controlled acceptance criteria, the secondary members must also be checked. The following calculations present the checks for a perpendicular gravity beam (W21x44) for column removal 1.

Acceptance checks of gravity beams in steel frame structures present a unique challenge within the framework of linear static analysis. While force- and deformation- controlled actions can be checked in a straight-forward manner with nonlinear procedures, the linear static procedure and criteria are based on m-factors applied to the moment and other deformation-controlled actions. As a result, actual forces (i.e. moments) must be determined to perform the checks, even at the ends of gravity beams which are often considered to be pinned. For the purposes of these Guidelines, simple shear tab connections can be considered partially restrained (PR) connections and their flexural strength can be calculated with an approximate rotational stiffness and the overall rotations for comparison to the flexural demand.

#### E3.3.3.4 DEFORMATION CONTROLLED ACTIONS

For the gravity beam and the simple shear tab connection, the deformation controlled actions are moments.

##### E4.3.1.1.1 GRAVITY BEAM

There are two contributions to the peak moment demand in the gravity beam. The first is due to the factored linear static load corresponding to the beam's tributary area which includes the applicable load increase factors used in the original linear static analysis. This is required because while the gravity beam is not explicitly included in the linear static model, it will experience dynamic and nonlinear effects, which the load increase factors capture. This is calculated using Equation 3.3:

$$w = G_{LD} = \Omega_{LD} [1.2D + (0.5L \text{ or } 0.2S)]$$

$$= 3.206 [1.2 (SW + DL_{floor} + SDL) + 0.5(LL_{floor})] = 3.83 \text{ kip/ft}$$

where  $\Omega_{LD}$  = Load increase factor = 3.206 for column removal 1

$$SW = \text{Self weight} = 44 \frac{\text{lb}}{\text{ft}} \text{ for W21x44}$$

$$DL_{floor} = \text{Dead load of floor over tributary area of gravity beam} = 78 \text{ psf} \times 10 \text{ ft}$$

$$SDL = \text{Superimposed dead load over tributary area of gravity beam} = 15 \text{ psf} \times 10 \text{ ft}$$

$$LL_{floor} = \text{Live load of floor over tributary area of gravity beam} = 50 \text{ psf} \times 10 \text{ ft}$$

The second contribution is the end moment created by the rotational stiffness of the simple shear tab connection and the relative displacement at the end of the beam, as determined from the linear static analysis under the considered column removal. The relative displacement is the difference between the displacements of the beams on either side of the secondary element at the location where the secondary element connects to the primary beam. The displacements for this example are shown in the screenshots in Figure E4.21 and Figure E4.22.

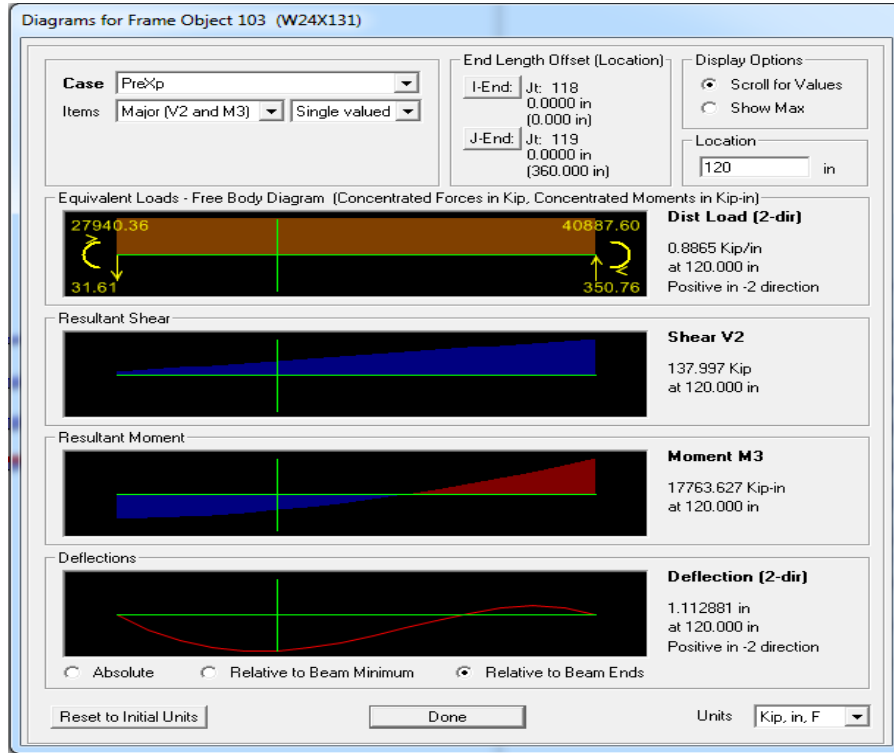


Figure E4.21: Displacement of Beam along Gridline C with Deformation Controlled Action

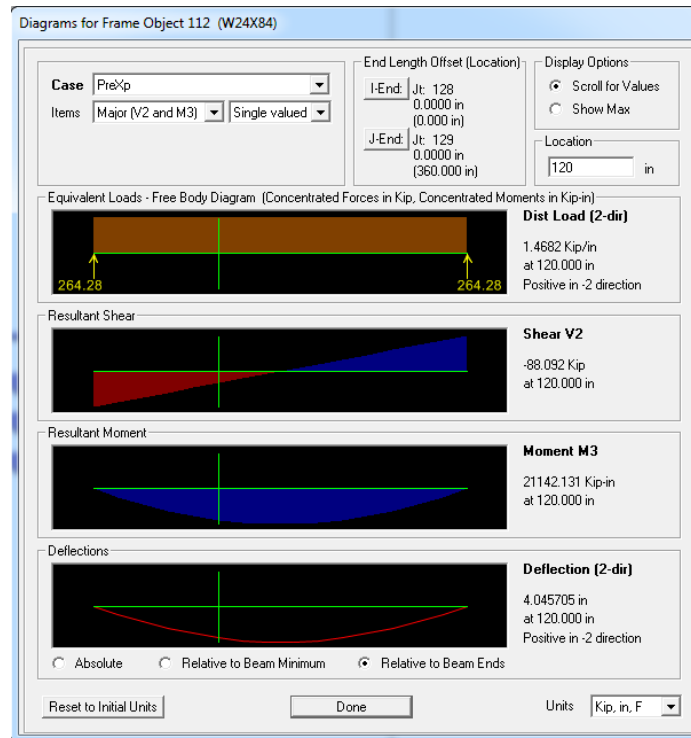


Figure E4.22: Displacement of Beam along Gridline B with Deformation Controlled Action



The relative displacement is calculated as:

$$\Delta = \Delta_{Int} - \Delta_{Ext} = 4.04 \text{ in} - 1.11 \text{ in} = 2.93 \text{ in}$$

where,

$\Delta$  = Relative Displacement

$\Delta_{Int}$  = Displacement of beam along interior gridline at location of secondary beam connection

$\Delta_{Ext}$  = Displacement of beam along exterior gridline at location of secondary beam connection

The rotation is then calculated as:

$$\theta = \frac{\Delta}{L} = \frac{2.93 \text{ in}}{528 \text{ in}} = 0.0055 \text{ rad}$$

where,

$\theta$  = Chord rotation

$\Delta$  = Relative displacement

$L$  = Beam length = 44 ft = 528 in

To determine the resulting end moments, the approximate stiffness for a partially restrained connection is calculated using Equation 9-15 from ASCE 41 [10].

$$K_o = \frac{M_{CE}}{0.005}$$

where,

$K_o$  = Approximate stiffness for partially restrained connections

$M_{CE}$  = Expected moment strength of the simple shear tab connection

The expected moment strength for the simple shear connection is based on the shear strength of the connection multiplied by the eccentricity of the bolt group, which is 3.5-in in accordance with Figure 10-11 of the AISC Manual of Steel Construction, 13<sup>th</sup> Edition [21]. The expected shear strength ( $V_{CE}$ ) from Table 10-9a of the AISC Manual [21] is 63.6-kips for (4) 3/4-inch A325N bolts. The expected moment strength and partially restrained connection stiffness are:

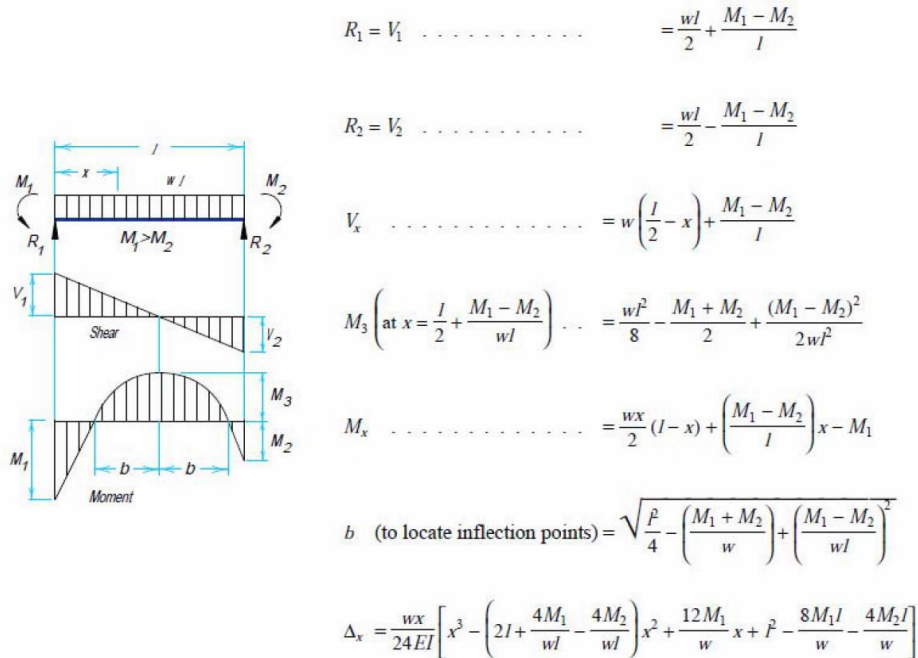
$$M_{CE} = 63.6 \text{ kips} * 3.5 \text{ in} = 222.6 \text{ kip in}$$

$$K_o = \frac{222.6 \text{ kip in}}{0.005} = 44520 \frac{\text{kip in}}{\text{rad}}$$

Thus, the end moment demands at the element can be calculated as:

$$M_1 = M_2 = K_o \theta = 44520 \frac{\text{kip in}}{\text{rad}} * 0.0055 \text{ rad} = 244.86 \text{ kip in} = 20.4 \text{ kip ft}$$

The combination of end moments and uniform load corresponds to the loading case shown in Figure E4.23, which is taken from AISC LRFD design manual [21].



**Figure E4.23: Shear & Moment in Simply-Supported Beam with End Moments and Uniform Loading**

The maximum moment demand is found using the equation for  $M_3$  in Figure E4.23:

$$M_3 = \frac{wL^2}{8} - \frac{(M_1 + M_2)}{2} + \frac{(M_1 - M_2)^2}{2wL^2}$$

$$M_3 = \frac{3.83 \frac{\text{kip}}{\text{ft}} * (44 \text{ ft})^2}{8} - \frac{20.4 \text{ kip ft} + 20.4 \text{ kip ft}}{2} + \frac{(20.4 \text{ kip ft} - 20.4 \text{ kip ft})^2}{2 * 3.83 \frac{\text{kip}}{\text{ft}} * (44 \text{ ft})^2}$$

$$M_3 = Q_{UD} = 906.5 \text{ kip ft}$$

This is the demand ( $Q_{UD}$ ) for the gravity beam. For a W21x44, the expected moment strength is:

$$Q_{CE} = \Omega F_y Z_x = 1.1 * 50 \text{ ksi} * 95.4 \text{ in}^3 = 437.3 \text{ kip ft}$$

where,

- $Q_{CE}$  = Expected strength of the beam
- $\Omega$  = Overstrength factor = 1.1 from ASCE 41 – 06 Table 9 – 3
- $F_y$  = Yield strength = 50 ksi
- $Z_x$  = Plastic modulus, from AISC LRFD design manual = 95.4 in<sup>3</sup>

Comparing the DCR with the corresponding m-factor (m = 11.05) calculated as part of Section E3.3.3:

$$\Phi m Q_{CE} \geq Q_{UD}$$

$$0.9(11.05)(437.3 \text{ kip ft}) = 4723 \text{ kip ft} \geq 906.5 \text{ kip ft} \quad \text{OK}$$

#### E4.3.1.1.2 SIMPLE SHEAR TAB CONNECTION

A somewhat similar procedure is performed for the simple shear tab connection. In this case, the first moment demand is created by the shear reaction from the factored linear static load multiplied by the eccentricity of the bolt group (3.5-in).

$$w = G_{LD} = 3.206 [1.2 (SW + DL_{floor} + SDL) + 0.5(LL_{floor})] = 4.5 \text{ kip/ft}$$

$$V = \frac{wL}{2} + \frac{M_1 - M_2}{L} = \frac{3.83 \frac{\text{kip}}{\text{ft}} * 44 \text{ ft}}{2} + \frac{20.4 \text{ kip ft} - 20.4 \text{ kip ft}}{44 \text{ ft}} = 84.26 \text{ kips}$$

$$M_{Dload} = V * e = 84.26 \text{ kips} * 3.5 \text{ in} = 294.9 \text{ kip in} = 24.6 \text{ kip ft}$$

The second moment demand is generated by the relative displacement at the end of the gravity beam as calculated from the linear static model for column removal 1. The chord rotation is as before,  $\theta = 0.0055$ -rad. The approximate stiffness for a partially restrained connection is calculated with Equation 9-15 of ASCE 41, or  $K_o = 44520$  kip-in/rad. The moment demand is:

$$M_{Ddispl} = K_o \theta = 20.4 \text{ kip ft}$$

The total demand is:

$$M_{UD} = M_{Dload} + M_{Ddispl} = 24.6 \text{ kip ft} + 20.4 \text{ kip ft} = 45 \text{ kip ft} = 540 \text{ kip in}$$

The strength of the simple shear tab connection was calculated earlier and is based on the design shear load for the connection times the eccentricity of the bolt group or:

$$M_{CE} = 63.6 \text{ kip} * 3.5 \text{ in} = 222.6 \text{ kip in}$$

Comparing the DCR with the corresponding m-factor ( $m = 13.5$ ) calculated as part of Section E3.3.3:

$$\Phi m Q_{CE} \geq Q_{UD}$$

$$0.9(13.5)(222.6 \text{ kip ft}) = 2704.6 \text{ kip in} \geq 540 \text{ kip in} \quad \text{OK}$$

#### E3.3.3.5 FORCE CONTROLLED ACTIONS

For the gravity beam and the simple shear tab connection the force-controlled action is shear. The calculation of the peak shear demand in the gravity beam and connection is calculated similar to the moment in the previous section; however results from the force-controlled model are used.

##### E4.3.1.2.1 GRAVITY BEAM

There are two contributions to the peak moment demand in the gravity beam. The first is due to the factored linear static load corresponding to the beam's tributary area, which includes the applicable load increase factors used in the original linear static analysis.

The distributed load on the beam is the factored linear static load as calculated with Equation 3.5:

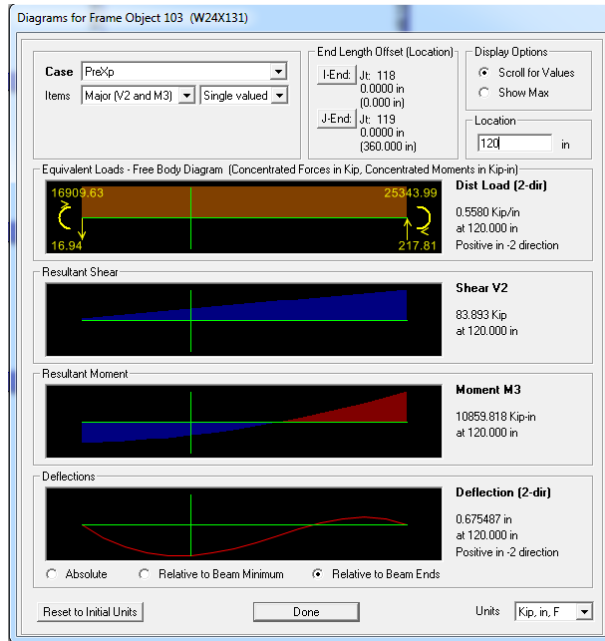
$$w = G_{LF} = \Omega_{LF} [1.2D + (0.5L \text{ or } 0.2S)]$$

$$w = G_{LF} = 2 [1.2 (SW + DL_{floor} + SDL) + 0.5(LL_{floor})] = 3.34 \text{ kip/ft}$$

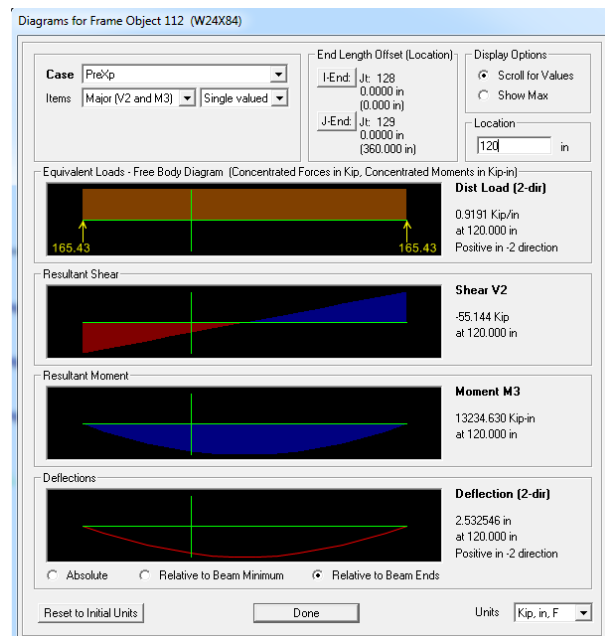
The second contribution is the end moment created by the rotational stiffness of the simple shear tab connection and the relative displacement at the end of the beam, as determined from the linear static



analysis under the considered column removal. The relative displacement is the difference between the displacements of the beams on either side of the secondary element at the location where the secondary element connects to the primary beam. The displacements for this example are shown in the screenshots in Figure E4.24 and Figure E4.25.



**Figure E4.24: Displacement of Beam along Gridline C with Force Controlled Action**



**Figure E4.25: Displacement of Beam along Gridline B with Force Controlled Action**

The relative displacement is calculated as:

$$\Delta = \Delta_{Int} - \Delta_{Ext} = 2.53 \text{ in} - 0.675 \text{ in} = 1.86 \text{ in}$$



where,

$\Delta =$  Relative Displacement

$\Delta_{int} =$  Displacement of beam along interior gridline at location of secondary beam connection

$\Delta_{Ext} =$  Displacement of beam along exterior gridline at location of secondary beam connection

The rotation is then calculated as:

$$\theta = \frac{\Delta}{L} = \frac{1.86 \text{ in}}{528 \text{ in}} = 0.0035 \text{ rad}$$

where,

$\theta =$  Chord rotation

$\Delta =$  Relative displacement

$L =$  Beam length = 44 ft = 528 in

To determine the resulting end moments, the approximate stiffness for a partially restrained connection is calculated using Eq. 9-15 from ASCE 41-06, as calculated earlier:

$$K_o = \frac{M_{CE}}{0.005}$$

where,

$K_o =$  Approximate stiffness for partially restrained connections

$M_{CE} =$  Expected moment strength of the simple shear tab connection

The expected moment strength and partially restrained connection stiffness are:

$$M_{CE} = 63.6 \text{ kips} * 3.5 \text{ in} = 222.6 \text{ kip in}$$

$$K_o = \frac{222.6 \text{ kip in}}{0.005} = 44520 \frac{\text{kip in}}{\text{rad}}$$

Thus, the end moment demands are:

$$M_1 = M_2 = K_o \theta = 44520 \frac{\text{kip in}}{\text{rad}} * 0.0035 \text{ rad} = 155.82 \text{ kip in} = 13.0 \text{ kip ft}$$

The maximum shear demand is found using the equation for  $V_1$  in Figure E4.23:

$$V_1 = \frac{wL}{2} + \frac{M_1 - M_2}{L}$$

$$V_1 = \frac{3.34 \frac{\text{kip}}{\text{ft}} * 44 \text{ ft}}{2} + \frac{13.0 \text{ kip ft} - 13.0 \text{ kip ft}}{44 \text{ ft}}$$

$$V_1 = 73.5 \text{ kips}$$

This is the demand or  $V_{UF}$  for the gravity beam. For a W21x44, the lower bound shear strength is:

$$V_{CL} = 0.6t_w d F_y = 0.6(0.35 \text{ in})(20.66 \text{ in})(50 \text{ ksi}) = 216.9 \text{ kips}$$

where,



$t_w = \text{Web thickness for } W21 \times 44 = 0.35 \text{ in}$

$d = \text{Depth of } W21 \times 44 = 20.66 \text{ in}$

$F_y = \text{Yield stress} = 50 \text{ ksi}$

Checking Equation 3-13:

$$\Phi Q_{CL} \geq Q_{UF}$$

$$0.9(216.9 \text{ kips}) = 195.2 \text{ kips} \geq 74.4 \text{ kips}$$

**OK**

#### E4.3.1.2.2 SIMPLE SHEAR TAB CONNECTION

The first moment demand is created by the shear reaction from the factored linear static load multiplied by the eccentricity of the bolt group (3.5-in).

$$w = G_{LF} = 2 [1.2 (SW + DL_{floor} + SDL) + 0.5(LL_{floor})] = 3.34 \text{ kip/ft}$$

$$V_{Dload} = \frac{wL}{2} + \frac{M_1 - M_2}{L} = \frac{3.34 \frac{\text{kip}}{\text{ft}} * 44 \text{ ft}}{2} + \frac{13.0 \text{ kip ft} - 13.0 \text{ kip ft}}{44 \text{ ft}} = 74.4 \text{ kips}$$

The second shear demand is generated by the moment created by relative displacements at the end of the gravity beam, as calculated from the linear static model for column removal 1 with the factored force-controlled linear static load. The chord rotation and stiffness are as before,  $\theta = 0.0035\text{-rad}$  and  $K_o = 44520 \text{ kip-in/rad}$ . This moment demand is:

$$M_{Ddispl} = K_o \theta = 44520 \frac{\text{kip in}}{\text{rad}} 0.0035 \text{ rad} = 155.82 \text{ kip in}$$

From statics for a beam subjected to two end moments, the shear demand due to displacement is:

$$V_{Ddispl} = \frac{2M_{Ddispl}}{L} = \frac{2(155.82 \text{ kip in})}{528 \text{ in}} = 0.59 \text{ kips}$$

The total demand is:

$$V_{UF} = V_{Dload} + V_{Ddispl} = 74.4 \text{ kips} + 0.59 \text{ kips} = 75.0 \text{ kips}$$

The lower bound shear strength of the simple shear tab connection is taken from Table 10-9a of the AISC Manual [21].

$$V_{CL} = 63.6 \text{ kips}$$

Evaluating the demand-capacity ratio (DCR):

$$\Phi Q_{CL} \geq Q_{UF}$$

$$0.9(63.6 \text{ kips}) = 57.2 \text{ kips} \geq 75.0 \text{ kips}$$

**NG**

Thus, the shear strength of the simple shear tab connection must be increased. Since the baseline design strength of the connection is based on the conventional design load combination (1.2D + 1.6L) and the demand is based on the modified extreme load combination (1.2D + 0.5L) multiplied by the  $\Omega_{LF}$  of 2, this is not unexpected. Therefore, the strength of the simple shear tab must be increased to 75.0 kips and the deformation controlled action (the moment) for the connection must be re-checked. For this example, the deformation controlled action is acceptable by inspection.



Note that the axial force in these beams and connections and the performance of the concrete slab are considered sufficient based on inspection due to the small rotations and are not explicitly evaluated.

## E5 REDUNDANCY REQUIREMENTS

The intent of redundancy requirements is to prevent structural designs where progressive collapse resistance is localized at one floor and to encourage balanced and redundant designs that distribute resistance up the height of the building. For the purpose of this example, only Column Removal 1 is considered; however in actual application, redundancy requirements shall be applied at each exterior column removal location.

### E5.1 LOCATION REQUIREMENTS

Load redistribution systems must be spaced vertically along the height of the structure and the spacing between the systems must not exceed three floors. A redistribution system is defined as a structural system that has the capability to redistribute gravity loads to adjacent vertical structural elements under the loss of a column or load-bearing wall.

The number of load redistribution systems in the structure,  $n$ , must meet Equation 3.13:

$$n \geq \frac{N}{3}$$

where,

$n$  = Number of vertical load redistribution systems

$N$  = Total number of floors

For the four-story building utilized in this example,  $n$  is required to be:

$$n \geq \frac{4}{3} = 1.33$$

Rounding up to the nearest integer:  $n = 2$

Therefore, two load redistribution systems are required. For the purposes of this example, it is the systems are located at Level 2 and Level 4; however in general, the location of load redistribution systems is at the discretion of the designer, provided it meets the minimum spacing requirement of three floors.

### E5.2 STRENGTH REQUIREMENTS

The strength of each vertical load redistribution system must meet the following equation:

$$\left| \frac{Q_{Ri} - \overline{Q_R}}{\overline{Q_R}} \right| \leq 0.3$$

where,

$Q_{Ri} = \sum \Phi Q_C$  = Design strength of a given load redistributing system

at a single floor level associated with the exterior ground level column and/or

*wall plan removal location under construction.*

$Q_c$  = *Expected strength of a component or element contributing to strength of a load redistribution system at a single floor level associated with the exterior ground level column and/or wall plan removal location under construction.*

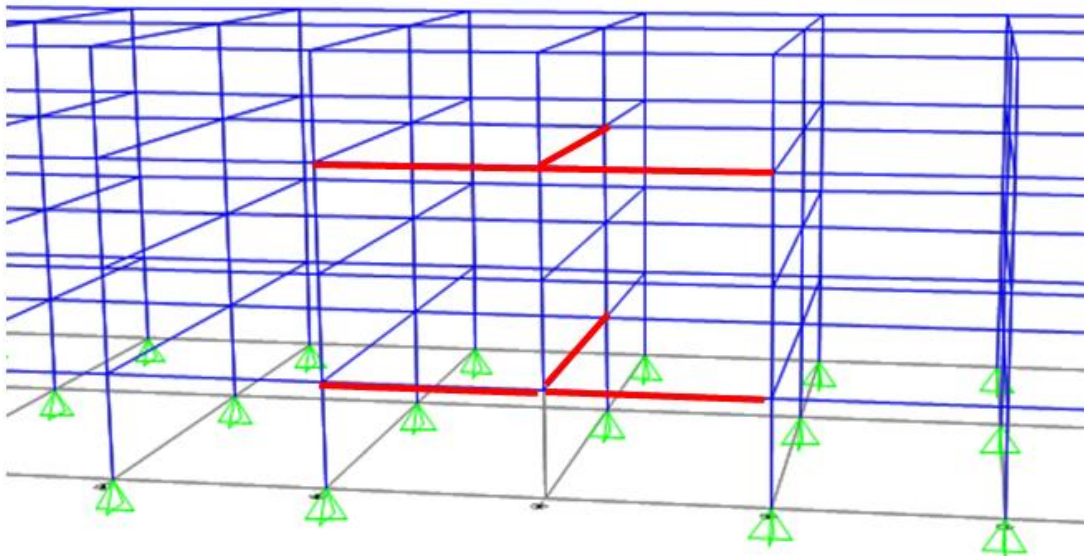
$\overline{Q_R} = \frac{\sum_{i=1}^n Q_{Ri}}{n}$  = *Average design strength of load redistributing systems up the height of the building associated with the exterior ground level column and/or wall plan removal location under construction.*

$\Phi$  = *Strength reduction factor from the appropriate material specific code*

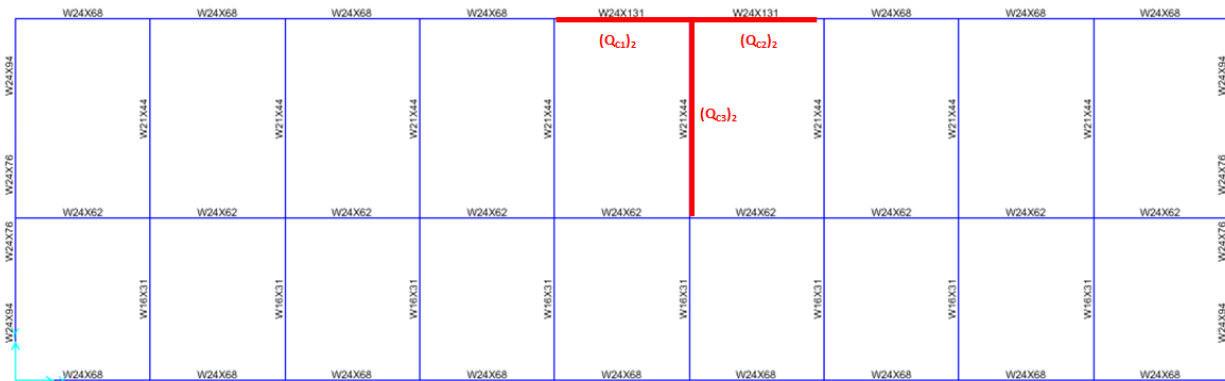
The load redistribution system should include all primary horizontal members contributing to the redistribution of the gravity loads. The extent of the horizontal members included in the load redistribution system at a given plan location should be limited to a single structural bay perpendicular to and in either direction of the column removal location.

### E5.2.1 COLUMN REMOVAL 1

The extent of horizontal members contributing to the vertical load redistribution system at Column Removal 1 is shown in the 3D isometric in Figure E5.1 and at each plan location for Level 2 (Figure E5.2) and Level 4 (Figure E5.3).



**Figure E5.1: Load Redistribution System for Column Removal 1**



Level 2

**Figure E5.2: Load Redistribution System at Level 2 for Column Removal 1**



Level 4

**Figure E5.3: Load Redistribution System at Level 4 for Column Removal 1**

The design strength of each horizontal element contributing to the vertical load distribution system at Level 2 is calculated as the minimum of the beam or its connections. For the perimeter moment frame elements, the WUF connection is assumed to be a fully restrained connection that is capable of developing the moment capacity of the beam; therefore the design strength of the element is governed by the beam section itself:

$$(Q_{C1})_2 = \Phi F_y Z_{x1} = 0.9(50 \text{ ksi})(370 \text{ in}^3) = 16650 \text{ kip in}$$

$$(Q_{C2})_2 = \Phi F_y Z_{x2} = 0.9(50 \text{ ksi})(370 \text{ in}^3) = 16650 \text{ kip in}$$

where,

$$\Phi = \text{Strength reduction factor for steel in bending} = 0.9$$

$$F_y = \text{Yield strength of A992 steel} = 50 \text{ ksi}$$

$$Z_{x1} = Z_{x2} = \text{Plastic section modulus of W24x131} = 370 \text{ in}^3$$



For the simple shear tab connections at gravity beams, the design strength is governed by the connection, which is modeled as a partially restrained moment connection. The expected design strength of the simple shear tab connection was calculated as part of Section E4.3.1.1.2 as follows:

$$(Q_{C3})_2 = \Phi M_{CE} = 0.9 * 222.6 \text{ kip in} = 200 \text{ kip in}$$

The total design strength for the vertical load redistribution system at Level 2 is the sum of all contributing elements:

$$Q_{R2} = \sum \Phi Q_C = (Q_{C1})_2 + (Q_{C2})_2 + (Q_{C3})_2 = 16650 \text{ kip in} + 16650 \text{ kip in} + 200 \text{ kip in}$$

$$Q_{R2} = 33500 \text{ kip in}$$

Similarly, the design strength of each horizontal element contributing to the vertical load distribution system at Level 4 is calculated as:

$$(Q_{C1})_4 = \Phi F_y Z_{x1} = 0.9(50 \text{ ksi})(327 \text{ in}^3) = 14715 \text{ kip in}$$

$$(Q_{C2})_4 = \Phi F_y Z_{x2} = 0.9(50 \text{ ksi})(327 \text{ in}^3) = 14715 \text{ kip in}$$

$$(Q_{C3})_4 = \Phi M_{CE} = 200 \text{ kip in}$$

Where,

$$\Phi = \text{Strength reduction factor for steel in bending} = 0.9$$

$$F_y = \text{Yield strength of A992 steel} = 50 \text{ ksi}$$

$$Z_{x1} = Z_{x2} = \text{Plastic section modulus of W24x117} = 327 \text{ in}^3$$

And the total design strength for the vertical load redistribution system at Level 4 is the sum of all contributing elements:

$$Q_{R4} = \sum \Phi Q_C = (Q_{C1})_4 + (Q_{C2})_4 + (Q_{C3})_4 = 14715 \text{ kip in} + 14715 \text{ kip in} + 200 \text{ kip in}$$

$$Q_{R4} = 29630 \text{ kip in}$$

The average design strength is the average strength of all the vertical load redistribution systems for the column removal, which for this example, is Level 2 and 4 only.

$$\overline{Q_R} = \frac{\sum_{i=1}^n Q_{Ri}}{n} = \frac{Q_{R2} + Q_{R4}}{2} = \frac{33500 \text{ kip in} + 29630 \text{ kip in}}{2}$$

$$\overline{Q_R} = 31565 \text{ kip in}$$

The difference between the design strength at each floor and the average is calculated to verify it is within the 30% acceptable variance:

$$\left| \frac{Q_{Ri} - \overline{Q_R}}{\overline{Q_R}} \right| \leq 0.3$$

For Level 2:

$$\left| \frac{33500 \text{ kip in} - 31565 \text{ kip in}}{31565 \text{ kip in}} \right| = 0.06 \leq 0.3 \quad \text{OK}$$



For Level 4:

$$\left| \frac{29630 \text{ kip in} - 31565 \text{ kip in}}{31565 \text{ kip in}} \right| = 0.06 \leq 0.3 \quad \text{OK}$$

### E5.3 STIFFNESS REQUIREMENTS

The strength of each vertical load redistribution system must meet the following equation:

$$\left| \frac{K_{Ri} - \bar{K}_R}{\bar{K}_R} \right| \leq 0.3$$

where,

$K_{Ri} = \sum K_{CE} =$  Flexural stiffness of a given load redistributing system  
at a single floor level associated with the exterior ground level column and/or  
wall plan removal location under construction.

$K_{CE} =$  Flexural stiffness of a component or element contributing to strength  
of a load redistribution system at a single floor level associated with the exterior  
ground level column and/or wall plan removal location under construction.

$\bar{K}_R = \frac{\sum_{i=1}^n K_{Ri}}{n} =$  Average flexural stiffness of load redistributing systems up the height of the  
building associated with the exterior ground level column and/or wall plan removal  
location under construction.

#### E5.3.1 COLUMN REMOVAL 1

The same three horizontal members used to evaluate the strength of the vertical load redistribution system are used to evaluate the stiffness.

The stiffness of each horizontal element contributing to the vertical load distribution system at Level 2 is calculated based on the boundary conditions of the element, prior to the column removal. For simplicity, the rotational stiffness of the simple shear tab connection is ignored and the gravity beam ends are assumed to be pin.

$$K_{CE3} = \frac{384 EI_3}{5L_3^3} = \frac{384 * 29000 \text{ ksi} * 1140 \text{ in}^4}{5(528 \text{ in})^3} = 17.2 \frac{\text{kip}}{\text{in}}$$

For the perimeter moment frame, a fix-fix condition is assumed.

$$K_{CE1} = \frac{384 EI_1}{L_1^3} = \frac{384 * 29000 \text{ ksi} * 4020 \text{ in}^4}{(360 \text{ in})^3} = 959.5 \frac{\text{kip}}{\text{in}}$$

$$K_{CE2} = \frac{384 EI_2}{L_2^3} = \frac{384 * 29000 \text{ ksi} * 4020 \text{ in}^4}{(360 \text{ in})^3} = 959.5 \frac{\text{kip}}{\text{in}}$$

Where,

$E =$  Modulus of Elasticity for Steel = 29000 ksi





$$I_1 = I_2 = \text{Moment of Inertia of W24x131} = 4020 \text{ in}^4$$

$$I_3 = \text{Moment of Inertia of W21x55} = 1140 \text{ in}^4$$

$$L_1 = L_2 = \text{Length of Beam} = 30 \text{ ft} = 360 \text{ in}$$

$$L_3 = \text{Length of Beam} = 44 \text{ ft} = 528 \text{ in}$$

The total stiffness for the vertical load redistribution system at Level 2 is the sum of all contributing elements:

$$K_{R2} = \sum K_{CE} = K_{CE1} + K_{CE2} + K_{CE3} = 959.5 \frac{\text{kip}}{\text{in}} + 959.5 \frac{\text{kip}}{\text{in}} + 17.2 \frac{\text{kip}}{\text{in}}$$

$$K_{R2} = 1936.2 \frac{\text{kip}}{\text{in}}$$

Similarly, the stiffness of each horizontal element contributing to the vertical load distribution system at Level 4 is calculated as:

$$K_{CE1} = \frac{384 EI_1}{L_1^3} = \frac{384 * 29000 \text{ ksi} * 3540 \text{ in}^4}{(360 \text{ in})^3} = 844.9 \frac{\text{kip}}{\text{in}}$$

$$K_{CE2} = \frac{384 EI_2}{L_2^3} = \frac{384 * 29000 \text{ ksi} * 3540 \text{ in}^4}{(360 \text{ in})^3} = 844.9 \frac{\text{kip}}{\text{in}}$$

$$K_{CE3} = \frac{384 EI_3}{5L_3^3} = \frac{384 * 29000 \text{ ksi} * 1140 \text{ in}^4}{5(528 \text{ in})^3} = 17.2 \frac{\text{kip}}{\text{in}}$$

Where,

$$E = \text{Modulus of Elasticity for Steel} = 29000 \text{ ksi}$$

$$I_1 = I_2 = \text{Moment of Inertia of W24x117} = 3540 \text{ in}^4$$

$$I_3 = \text{Moment of Inertia of W21x55} = 1140 \text{ in}^4$$

$$L_1 = L_2 = \text{Length of Beam} = 30 \text{ ft} = 360 \text{ in}$$

$$L_3 = \text{Length of Beam} = 44 \text{ ft} = 528 \text{ in}$$

The total stiffness for the vertical load redistribution system at Level 4 is the sum of all contributing elements:

$$K_{R4} = \sum K_{CE} = K_{CE1} + K_{CE2} + K_{CE3} = 844.9 \frac{\text{kip}}{\text{in}} + 844.9 \frac{\text{kip}}{\text{in}} + 17.2 \frac{\text{kip}}{\text{in}}$$

$$K_{R4} = 1707.0 \frac{\text{kip}}{\text{in}}$$

The average stiffness is that for all the vertical load redistribution systems for the column removal, which for this example, is Level 2 and 4 only.

$$\overline{K_R} = \frac{\sum_{i=1}^n K_{Ri}}{n} = \frac{K_{R2} + K_{R4}}{2} = \frac{1936.2 \frac{\text{kip}}{\text{in}} + 1707.0 \frac{\text{kip}}{\text{in}}}{2}$$

$$\overline{K_R} = 1821.6 \frac{\text{kip}}{\text{in}}$$



The difference between the stiffness at each floor and the average is calculated to verify it is within the 30% acceptable variance:

$$\left| \frac{K_{Ri} - \overline{K_R}}{\overline{K_R}} \right| \leq 0.3$$

For Level 2:

$$\left| \frac{1936.2 \frac{\text{kip}}{\text{in}} - 1821.6 \frac{\text{kip}}{\text{in}}}{1821.6 \frac{\text{kip}}{\text{in}}} \right| = 0.063 \leq 0.3 \quad \text{OK}$$

For Level 4:

$$\left| \frac{1776.1 \frac{\text{kip}}{\text{in}} - 1890.6 \frac{\text{kip}}{\text{in}}}{1890.6 \frac{\text{kip}}{\text{in}}} \right| = 0.061 \leq 0.3 \quad \text{OK}$$

**END OF DOCUMENT**



## **PROJECT TEAM**

Development of these updated guidelines was performed by the following team:

### **GSA Project Team**

Office of Design & Construction

### **Primary Authors**

Hinman Consulting Engineers

### **Primary Reviewers**

Protection Engineering Consultants

### **Contributors**

Degenkolb Engineers

---